

Excess 15

OPTION GUIDE

Dear Dealer,

This document contains all the essential information you will need to understand and talk about options available aboard the EXCESS 15.

01. SAIL AWAY Pack
02. Sailing experience
03. Outside experience
04. Inside experience
05. Technical equipment
06. Accessories

The document refers to equipment from Price List B2022.

This support is a professional tool for your use only. Thank you to not forward it directly to clients but use it to improve your personal knowledge and to perform during client meetings.

This tool will be regularly upgraded according to model year changes and supplier evolutions. Please check regularly for updates. Last upgrade is indicated at the bottom of this page.

Remember, the Sales Guide is about product overview and key client benefits. For option details, please refer to this Options Guide. For technical information, please refer to your Technical Guide.

Enjoy your reading !

The Excess team

Indice A
SEPTEMBER 2021 EDITION



- 01** SAIL AWAY PACK
- 02** SAILING EXPERIENCE
- 03** OUTSIDE EXPERIENCE
- 04** INSIDE EXPERIENCE
- 05** TECHNICAL EQUIPMENT
- 06** ACCESSORIES



EXCESS 15

X Y

01

SAIL AWAY

Electric Pack

RAYMARINE Electronics 2021

Starboard double helm seat

Aft porthole in aft cabins with curtains

Lateral portholes in galley

Opening hatch in forward roof window

Starboard electric winch 50.2

Deck courtesy lights [Aft cockpit and transoms]

Lifeline openings

SAIL AWAY is an entry level finishing including options and packs.

ELECTRIC PACK

1 - 3x additional service batteries 140A



Service battery bank

STANDARD	SAIL AWAY	TOTAL
3 x 140A [AGM]	+ 3 x 140A [AGM]	6 x 140A [AGM]

Location on starboard engine compartment.

2 - Additional 60A charger



40A & 60A battery chargers | CRISTEC
Charge service batteries and engine

STANDARD	SAIL AWAY	TOTAL
40A	+ 60A	1 x 40A 1 x 60A

Location on starboard engine compartment.

3 - Battery controller



Power supply, charge level, lifespan.

A dedicated extra sensor allow to monitor the batteries lifespan and alert for replacing.

Location on starboard companionway

4 - Shore Power 32A

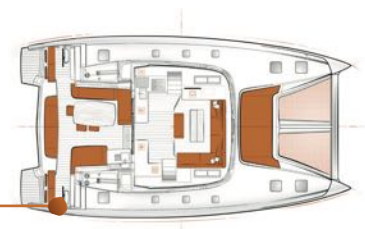

[Steering wheel no longer available]

5 - [230V outlet + double USB sockets] in cabins & 230V outlet / USB sockets in salon

Power sockets 230V

- Salon and galley: x6
- Per cabin: x2
- Forward cockpit locker [stbd]: x1
- Per engine compartment: x1

USB sockets [added to 230V power socket]

- Salon and galley: x2
- Per forward and middle cabin: x2
- Per aft cabin: x4

[Standard: 1x USB salon socket at the companionway. Only 230V]

LOCATION ON BOARD

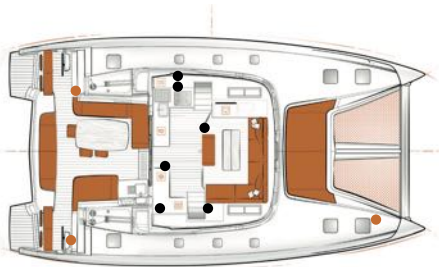

Salon

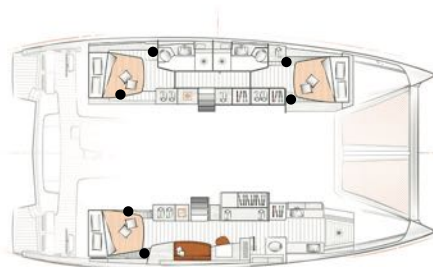

3C version

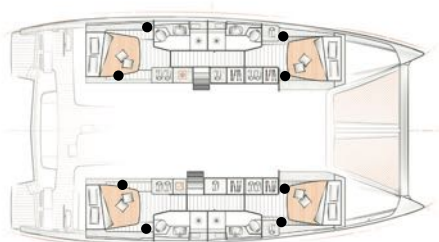

4C2T version

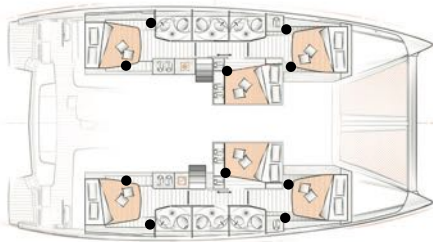

4C4T version

6 - Interior light monitoring



Screen size upgrade: 3.5" Touch screen [replaces the standard 2.4"]

Monitoring upgrade:

- Main battery banks: voltage & power INPUT | OUTPUT
- Start batteries [port & starboard] : voltage & power INPUT | OUTPUT
- Bow thruster batteries [option] : voltage & power INPUT | OUTPUT
- Chargers [40A & 60A] : voltage INPUT & total power consumption
- Charger [Generator option]:
- Grey water tank levels [Option]

Standard monitoring includes:

- Fuel tank levels
- Fresh water tank levels
- Black water tank levels

Lighting:

- ON|OFF for each cabin [Reading light not included]
- ON|OFF for salon [Chart table reading light not included]
- ON|OFF for cockpit

Standard monitoring includes:

- Lighting: Global ON|OFF [Reading lights and technical compartment lights not included]

A total ON|OFF control including head ceiling lights, reading lights, technical compartment lights.

Control switch at main DC panel at the chart table.

1 - Wind transducer

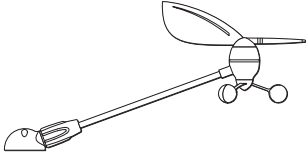

Raymarine Model: E22078

Raymarine

2 - Speed | Depth | Temp. Smart Transdu-

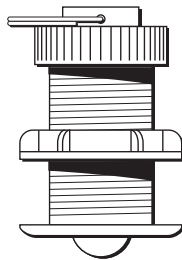
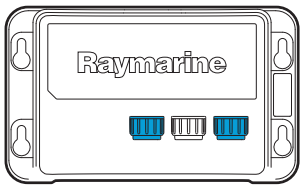

Raymarine Model : A2211

3 - Autopilot

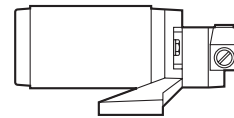
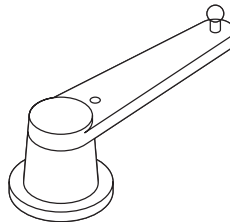
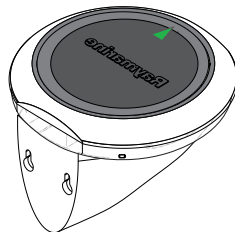
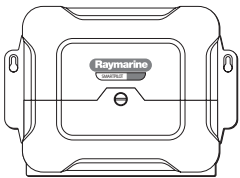

EV-19-axis compass sensor with built-in rate gyro.

ACU-400 actuator control unit and Rudder Reference

Raymarine Model: E70096 + E70100

L&S Hydraulic linear drive unit

4 - Equipment at starboard helm station [starboard GRP console included]

P70s

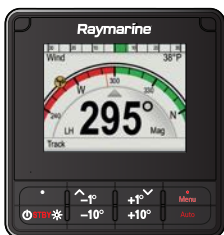

P70s Autopilot Control Head
Raymarine Model: E70331

I70s



I70s Colour instrument
Raymarine Model : E70330
i70s High-resolution colour display showing digital analogue and graphical formats with LightHouse III user interface.

5 - Portative compass



- 1 portative compass
- 2 supports
- 1 black clutch bags

NAVICOM Model: Compas 70UN Universal

STARBOARD DOUBLE HELM SEAT



[Color upholstery no longer available]



Double foldable seat on starboard helm station
Option includes a cover.

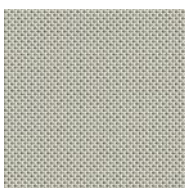

Color: Grey
FERRARI® Batyline Lounge Quartz
7720FR-50932

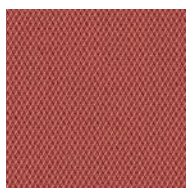

Color: Orange
SUNBRELLA® Mezzo Tigerlily
MEZZ 10222 140

AFT PORTHOLE IN AFT CABINS WITH CURTAINS



[Starboard]



[Port]

x1 **Opening porthole** per aft cabin, with curtains.

LEWMAR - Mitre T4 TWIST

Dimensions : 650 L x 190 W mm | 2'1" x 0'7"

LATERAL PORTHOLES IN GALLEY



x2 Opening portholes located on galley to port and starboard.

LEWMAR - Mitre T1

Dimensions: 370 x 200 mm | 1'2" x 0'7"

OPENING HATCH IN FORWARD ROOF WINDOW



x1 **Opening porthole** on central forward roof windows, in the salon.

LEWMAR - Mitre
Dimensions: 660 L x 340 W mm | 2'1" x 1'1"

STARBOARD ELECTRIC WINCH 50.2

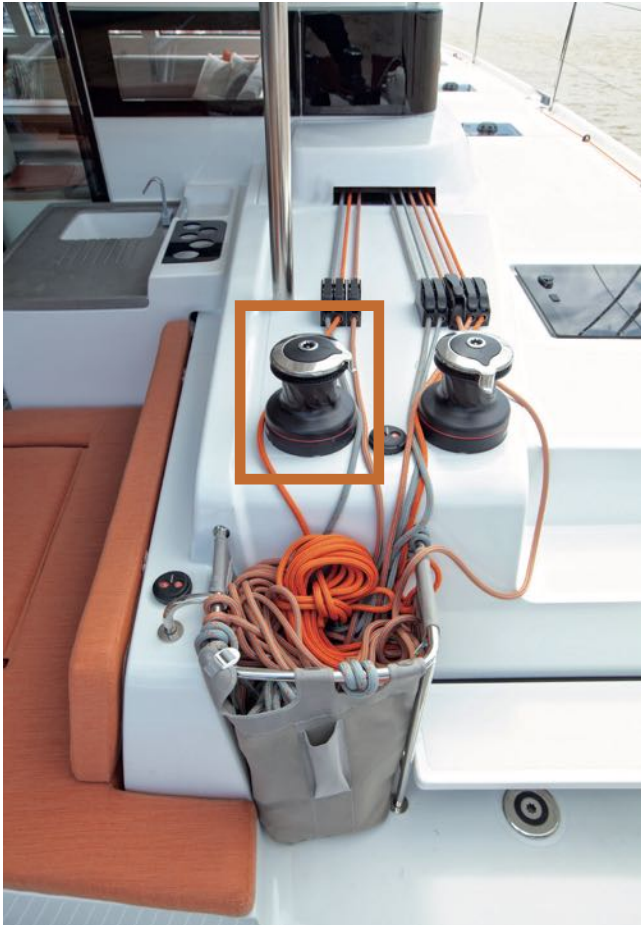

Electric upgrade from manual winch [per standard] on **starboard** helm station.

Brand: HARKEN
Model: 50.2 STEA

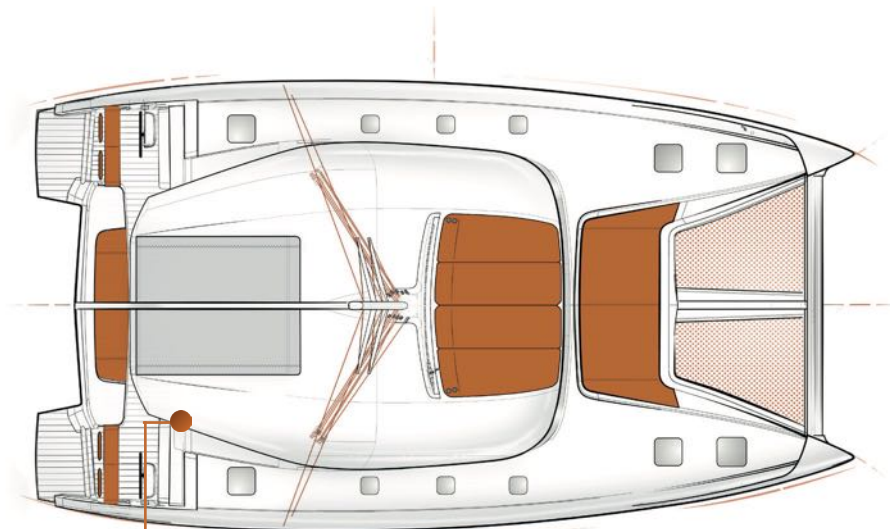

- 01 • Main sail sheet
- Reef 1
- Reef 3
- Mainsheet traveler [std]

01

Winch 50.2

Standard: Manual

SAIL AWAY Pack: [Electric upgrade](#) [Comes with the option]

DECK COURTESY LIGHTS [AFT COCKPIT AND TRANSOMS]



Brand: QUICK Marine
Model: Tina

Power supply: 12V

Deck courtesy lights on board
Transoms: x4
Aft cockpit: x6

LOCATION ON BOARD

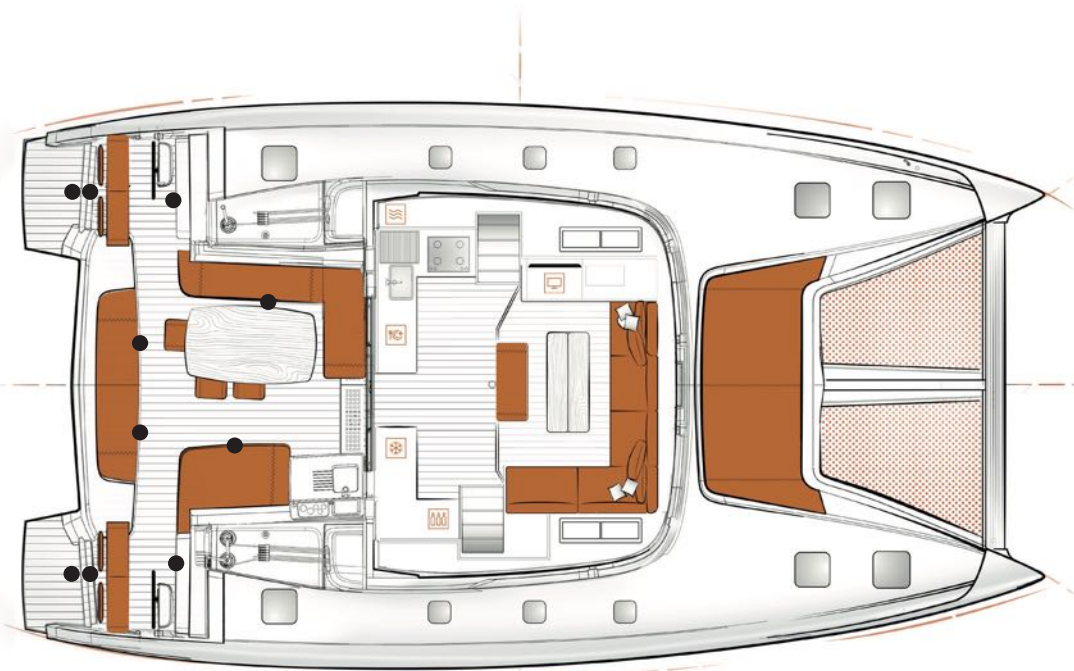



[Photos onboard EXCESS 12]



Standard: Stainless steel lifelines

SAIL AWAY: Stainless steel lifeline **openings**
[1 on portside and 1 on starboard]

02

SAILING EXPERIENCE

RIGGING AND SAILS

PULSE LINE [Pack]

Extra for FlatWinder on starboard aft beam

Extra for 2nd starboard 50.2 electric winch

Extra for port 50.2 electric winch

Code 0 Rig and Pole & Furler [Standard sail plan]

Asymmetrical spinnaker gear

Code 0 in Mylar

Asymmetrical spinnaker with socket

Aluminium canoe boom with cover

Lazy bag

ELECTRONICS

RAYMARINE Electronic Upgrade Pack

Upgrade for AXIOM 12" display

AIS 700 RAYMARINE transceiver with antenna coupling

RAYMARINE radar 4G Quantum Q24D Doppler

RAYMARINE realvision sounder

RAYMARINE pilote smart controller

VHF RAYMARINE single handset

2nd Wireless handset for VHF RAYMARINE

THE CHOICE OF BOLD SAILORS SEEKING SENSATIONS!

The PULSE LINE is undoubtedly an exciting pack from design point of view to sailing experience! You can sail faster, enjoy sporty sail trimming and a definitively eye-catching design.



The PULSE LINE pack includes the following options:

- 1- PULSE LINE **Rigging & Sails plan**
- 2- **Square top mainsail and self-tacking jib** in Pro Radial [Color: grey]
- 3- **Code 0 rig and pole & furler** [manual winch on port included]
- 4- **Barber hauler**
- 5- **Textile** lifelines
- 6- PULSE LINE **steering wheels** [Composite - Color: Orange]
- 7- PULSE LINE **hull decoration**

1 - Rigging & Sails plan

With PULSE LINE, the mast configuration [Std: 23,05 m | 75'7" ; Pulse: 25,5 m | 83'7"] offers a great sails plan with a **larger**:

- Mainsail
- Self-tacking jib
- Code 0 **SAIL** [The option is NOT included in this pack]



PULSE LINE increases SA/DSPL 7%, moving the ration to 4,92, 3% above standard. On the water there will be regularly a positive difference around 4%

PULSE LINE - Code 0
 PULSE LINE Main Sail and Jib



	STANDARD	PULSE LINE	%
Mast length	23.05 m 75'7"	25.5 m 83'7"	+ 11 %
Square top mainsail	99 m ² 1,065 sq ft	106 m ² 1,141 sq ft	+ 7 %
Self tacking jib	55 m ² 592 sq ft	59 m ² 635 sq ft	+ 7 %
Upwind sail area	154 m ² 1,657 sq ft	165 m ² 1,775 sq ft	+ 7 %
Code 0 [if option selected]	117 m ² 1,259 sq ft	127 m ² 1,367 sq ft	+ 8,5 %
Sail Area / Displacement	4.75	4.92	+ 3.5 %

2 - Square top mainsail and self-tacking jib in Pro Radial

The boat comes in standard with a square top mainsail using top quality white Dacron[®], with horizontal cut.

With the PULSE LINE we offer a higher tech Dacron[®] with a different horizontal and vertical split of the fiber called Pro Radial, made by the German company Dimension Polyant.

Together with a starcut assembly, it allows those larger sails to rise the stiffness of the sail, without the aging risks of laminar cloths.

Sails come in Grey color [in lieu of white Dacron[®] in standard].



Tri-radial cut
[non-contractual color]

Pro Radial - Tri-radial cut. **[PULSE LINE]**

Pro Radial fabric from Dimension POLYANT: warp-oriented woven polyester fiber ensuring a perfect adaptation of cut.

Tri-radial cut in accordance with the forces present in the sails.

Outstanding durability in shape and very good resistance against chafing

[Grey]



Horizontal cut
[non-contractual color]

Dacron[®] - Horizontal cut. **[STANDARD]**

Classic horizontal cut.

Dacron[®] sailcloth: weft-oriented woven polyester fiber, for a horizontal cut.

Good resistance & shape holding.

Excellent technical properties against chafing

[White]



3 - Code 0 Rig and Pole & Furler

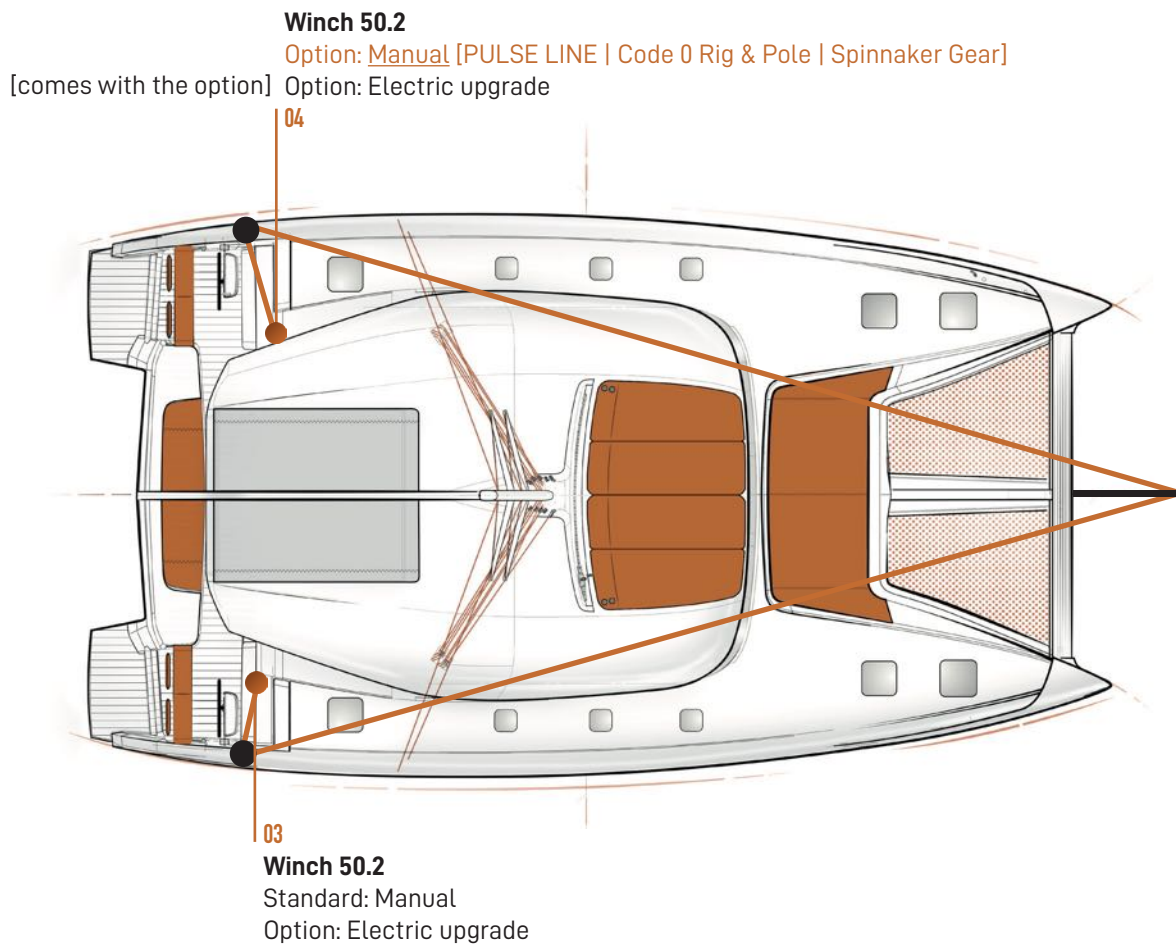

- 03 • Reef 2
- Topping lift
- Main sail halyard
- Jib sheet
- Jib halyard
- Jib furling line
- Code 0 sheet [option]
- Spinnaker sheet [option]

- 04 • Code 0 halyard
- Code 0 sheet
- Spinnaker halyard
- Spinnaker sheet



3 - Code 0 Rig and Pole & Furler

This option includes the following rigging:

A. Code 0 sheets rig

- Port Code 0 sheet
- Starboard Code 0 sheet
- 2 blocks with swivel – Black Magic, Ø 100 HARKEN® [Port and Starboard]

B. Code 0 halyard rig

- Mast foot block
- Roof block Rutgerson® - [Port]
- Deck block Rutgerson® - [Port]
- Jammer on portside Spinlock® - [Port]
- Code 0 halyard

C. Manual winch on portside + ropes storage

D. Ropes storage [Port]

Modification of port step for ropes storage fitting
Full length step in standard. Smaller step in option.

E. Code 0 furler

F. Pole

[Details and pictures on the following pages]

Please note, this option not include the sails: Code 0 or Asymmetrical Spinnaker.

PULSE LINE

3 - Code 0 Rig and Pole & Furler

A. Code 0 sheets rig

Block on starboard and port

Quantity: 2

Brand: HARKEN®

Model: IN3246 - Black Magic Single 100 mm



PULSE LINE

3 - Code 0 Rig and Pole & Furler

B. Code 0 halyard rig



Mast foot block - [Port]
Code 0 halyard- [Port]

Roof foot block Rutgerson® - [Port]

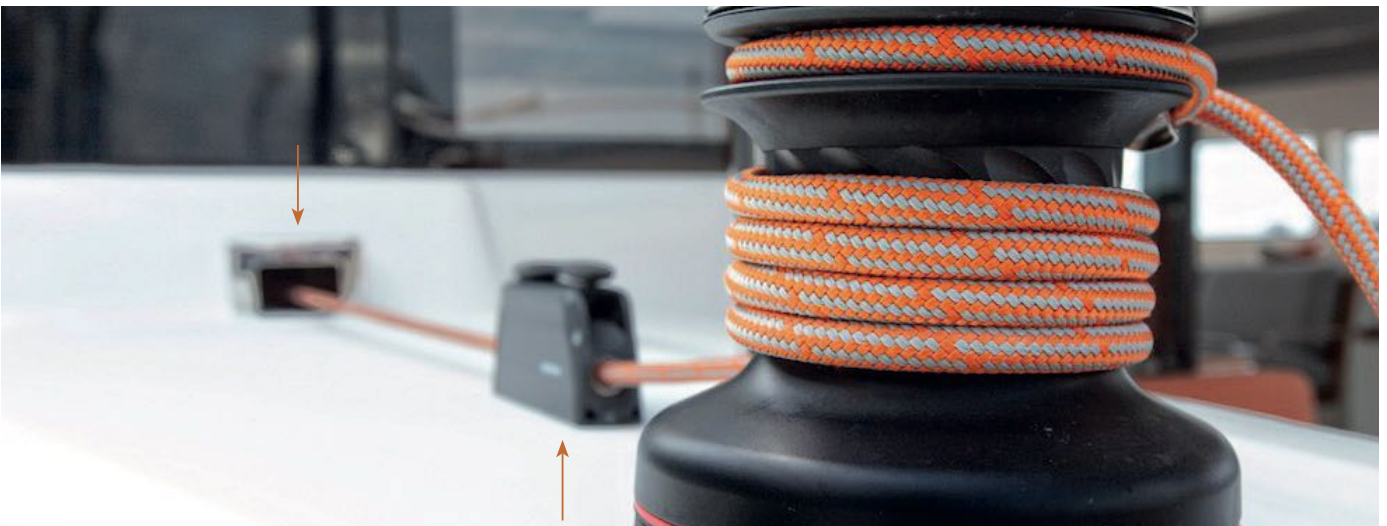

Deck foot block Rutgerson® - [Port]
Jammer Spinlock® - [Port]

PULSE LINE

3 - Code 0 Rig and Pole & Furler

C. Manual winch on portside



Winch 50.2 STA HARKEN® comes with ropes storage.

[This photo includes the electrical upgrade option]

D. Ropes storage



E. Code 0 furler

Facnor® FX+4500 Cliq



F. Pole

2,000 mm]

4 - Barber Hauler

A flying barber hauler is a 4:1 hoist [same principle as the hoist of a dinghy catamaran] designed to be used with the mainsail sheet when the boats sails downwind, when the leeward mainsheet hoist let's go the boom to a point where the boom starts to move as much up as out: the leech of the main opens up and will very soon end up against the leeward rig shroud

To avoid this loss of power and this risk of damaging the sail cloth the flying barber hauler comes in: its top part is to connect to the top loop of the leeward mainsheet below the boom, the bottom is to connect on a padeye on the leeward side of the sheer line

Once in place, one trims the leech of the mainsail with both this device and the leeward mainsheet hoist. It can also be used as a boom preventer when sailing long downwind tacks.

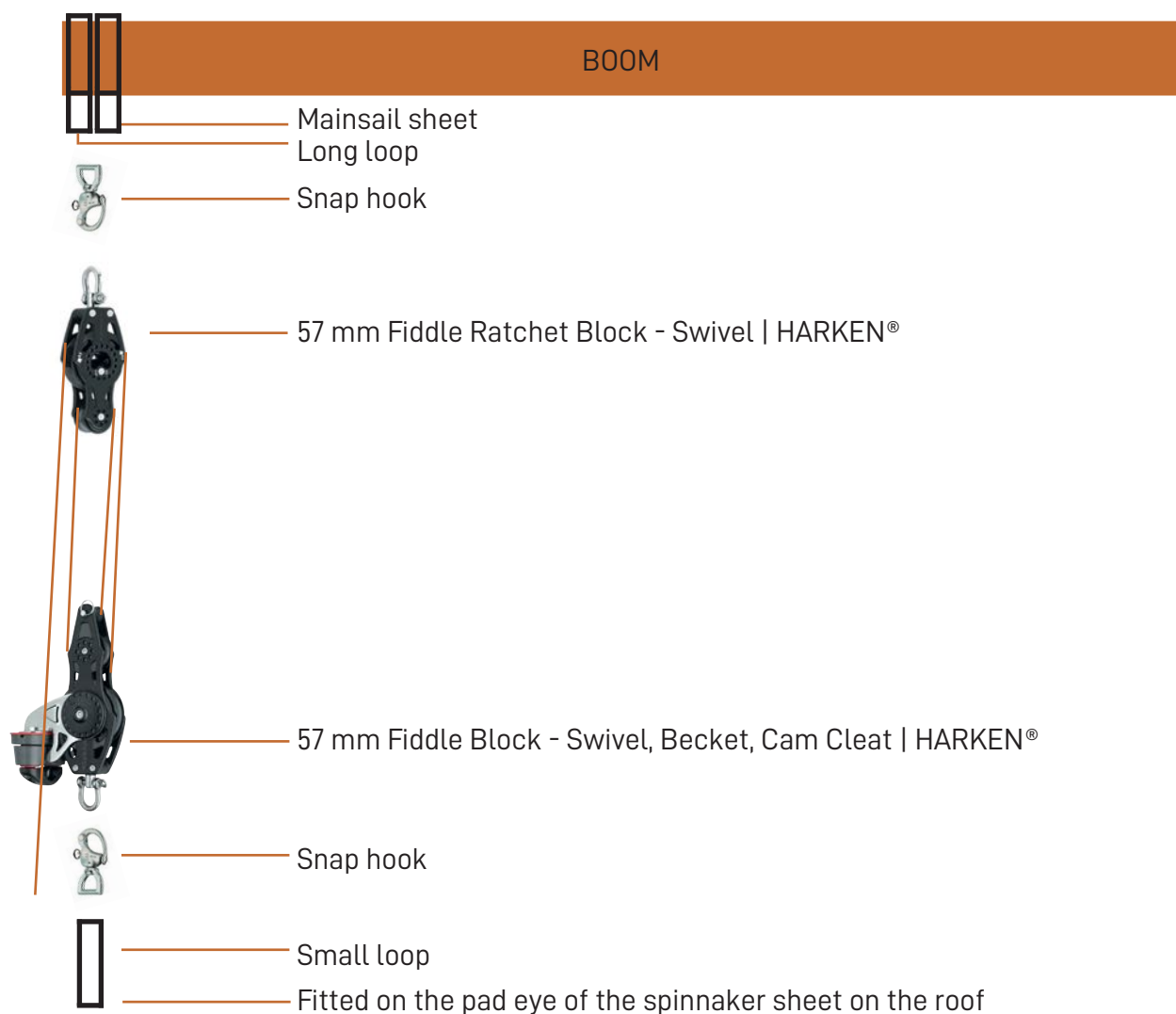

PULSE LINE

02

SAILING EXPERIENCE

RIGGING AND SAILS

4 - Barber Hauler

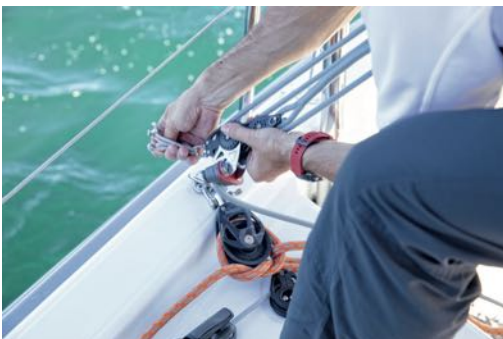

[Photos on EXCESS 11]

You can cleat it to the aft mooring cleats, on starboard if you are on a port tack, or on port if on a starboard tack. You will balance the tension on the flying barber-hauler and the leeward mainsheet to get a proper shape.

Do not forget to remove it before jibing or tacking!

5 - Textile lifelines

The textile lifelines replace the stainless steel standard lifelines.

Made from fiber for more efficiency, the customized Lancelin lifelines are **fluorescent at night for safer night cruising.**

OPTION

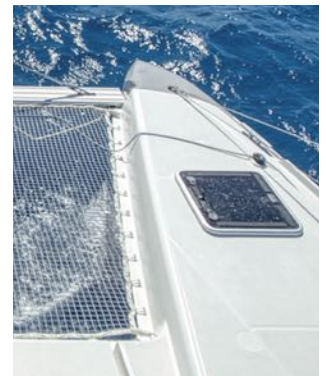
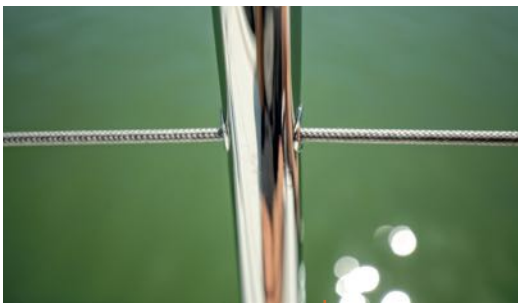
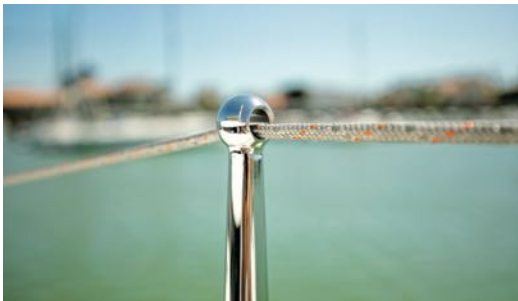

1

Brand: Lancelin
Material: Fiber
Color: Grey & orange

2

The pad-eye is part of the option.
By selecting the textile lifelines
you get also a pad-eye.

6 - PULSE LINE steering wheels



OPTION



This option replaces the standard s/s steering wheels
Upgrade for both helm stations.

Brand; CARBONAUTICA
Material: Composite
Color: Orange

[Carbonautica - Steering wheel](#)

STANDARD



[Photo onboard EXCESS 12]



Material: Stainless steel & leather
Color: Grey

7 - PULSE LINE hull decoration

We've created a distinction between the standard line and the sportier PULSE LINE, while maintaining the same spirit. The inspiration came from the logo, a sporty and elegant wake, fluid and dynamic, taken up in an immoderate way in its PULSE LINE version. Isabelle's interest in typography made the process almost natural. The combined lines at the back of the hulls highlight the turn of the bilges in a marked and legible manner.



HULL DECORATION BY ISABELLE KELLER



"I have sailed a lot, racing, with a crew and I have shared the life of a professional sailor for a long time. I have experienced ocean racing and great adventures like the Transats and the Vendée Globe, from the inside. And then, on a simpler level, I have always wanted to live by the sea, overlooking the Atlantic Ocean."
Isabelle Keller, designer of the hull decoration.

EXTRA FOR FLATWINDER ON STARBOARD AFT BEAM

02 SAILING EXPERIENCE

RIGGING AND SAILS

Electric flat winder on aft starboard.

Quantity: 1
 Brand: HARKEN®
 Model: FlatWinder

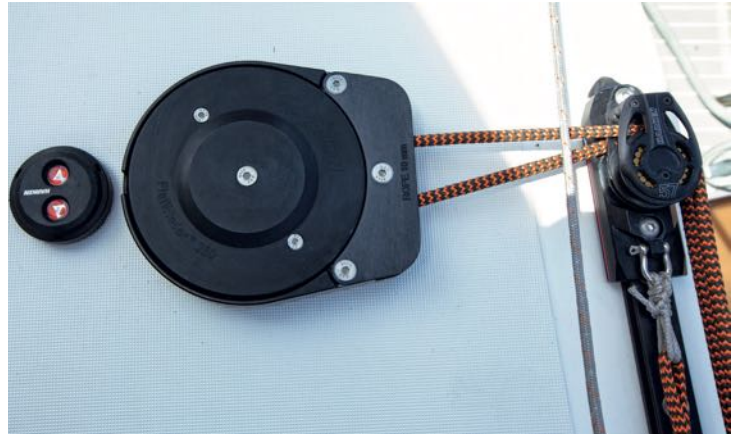

This self-contained electrically powered system is easy to use and offers sailors huge benefits in **mainsail control**, giving you the means to quickly depower the rig, and delay reefing when the wind picks up.

It operates in both directions allowing the car to move anywhere on the track while also keeping the traveler line off the cockpit floor.

Two Digital System Switches, one button to port, the other to starboard, are installed for activation from both sides of the boat.

[comes with the option]
 Standard: Double clutch
 Option: **Electric FlatWinder**

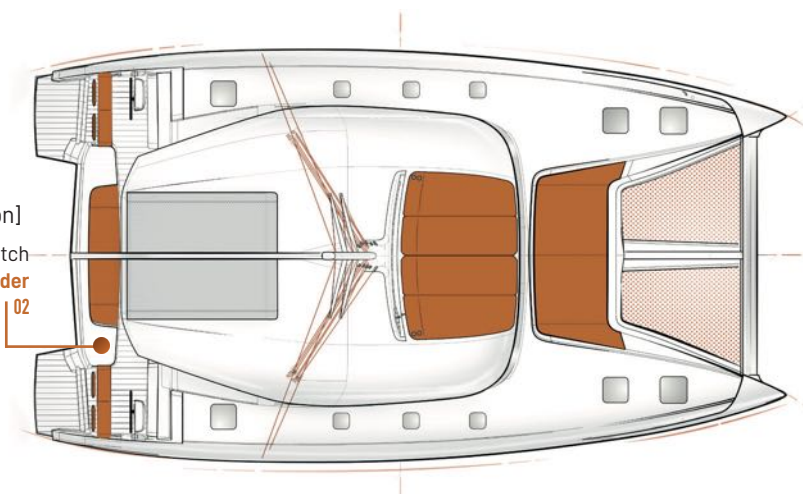

02 • Mainsheet traveler
 [option replacing standard]

EXTRA FOR 2ND STARBOARD 50.2 ELECTRIC WINCH

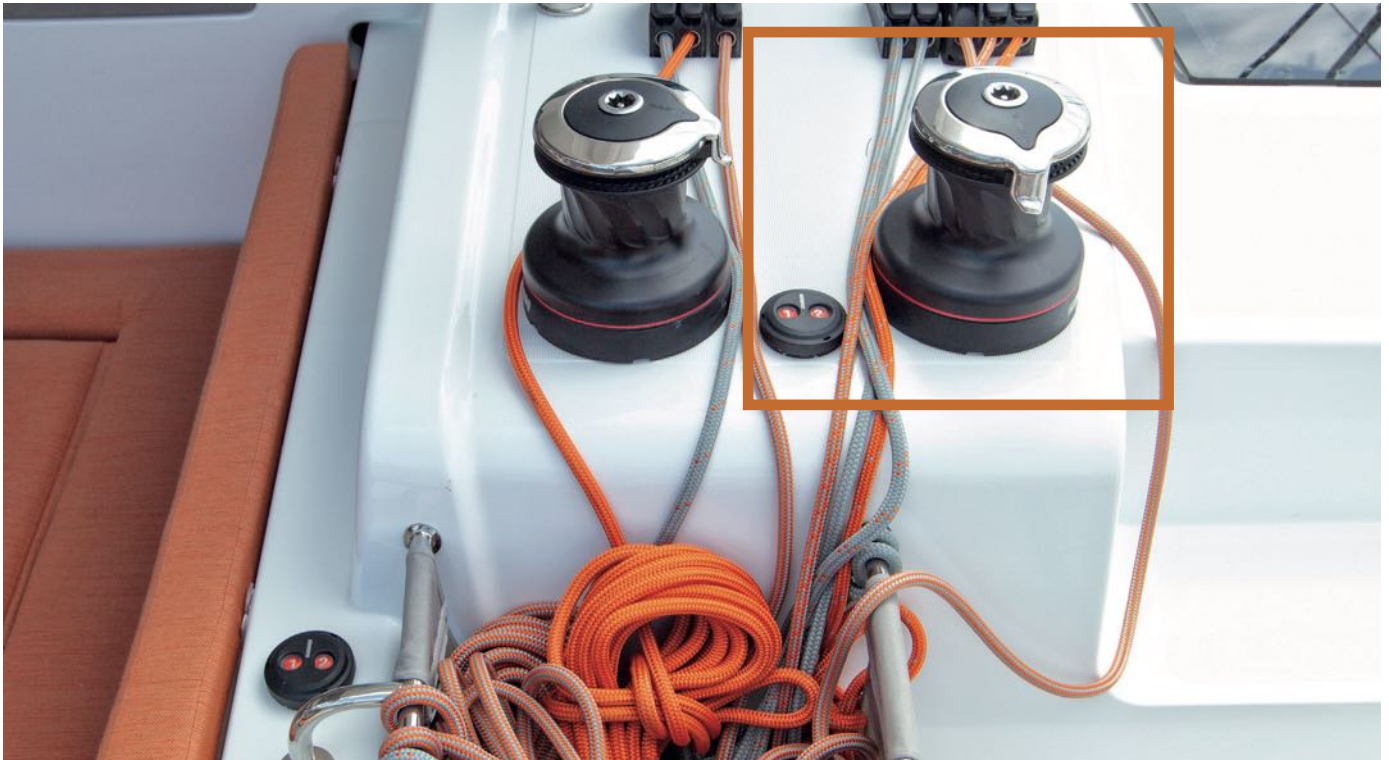

Electric upgrade from manual winch [per standard] on aft starboard.

Brand: HARKEN®
Model: 50.2 STEA

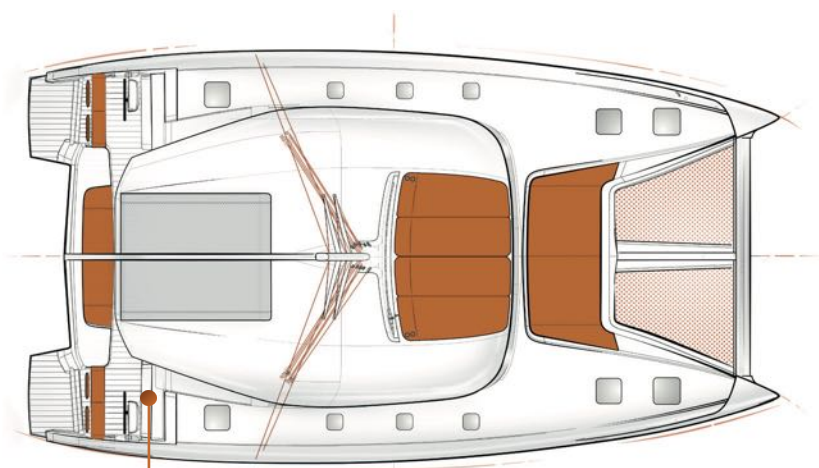

- 03 • Reef 2
- Topping lift
- Main sail halyard
- Jib sheet
- Jib halyard
- Jib furling line
- Code 0 sheet [option]
- Spinnaker sheet [option]

03
Winch 50.2
Standard: Manual
Option: **Electric upgrade** [comes with the option]

EXTRA FOR PORT 50.2 ELECTRIC WINCH

[PULSE LINE | Code 0 Rig & Pole | Spinnaker Gear option mandatory]



Electric upgrade from manual winch [per standard] on portside.

Brand: HARKEN®
Model: 50.2 STEA

Winch 50.2
Option: Manual [PULSE LINE | Code 0 Rig & Pole | Spinnaker Gear]
Option: Electric upgrade

[comes with the option]

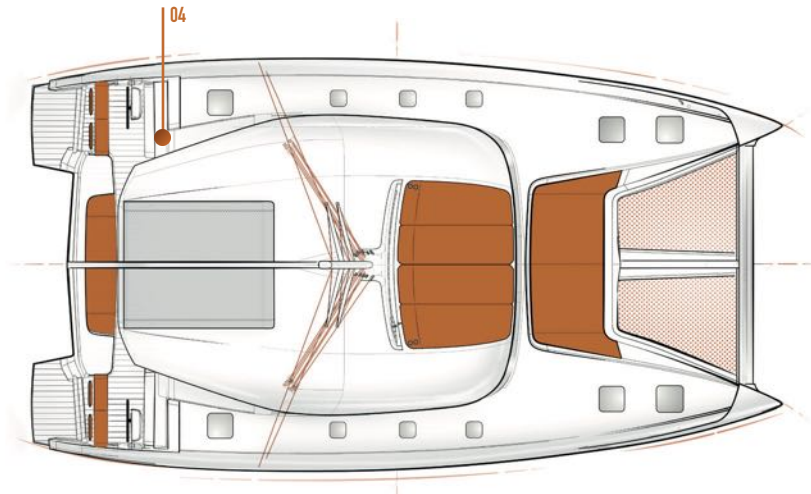

- 04 • Code 0 halyard
- Code 0 sheet
- Spinnaker halyard
- Spinnaker sheet

CODE 0 RIG AND POLE & FURLER

STANDARD SAIL PLAN

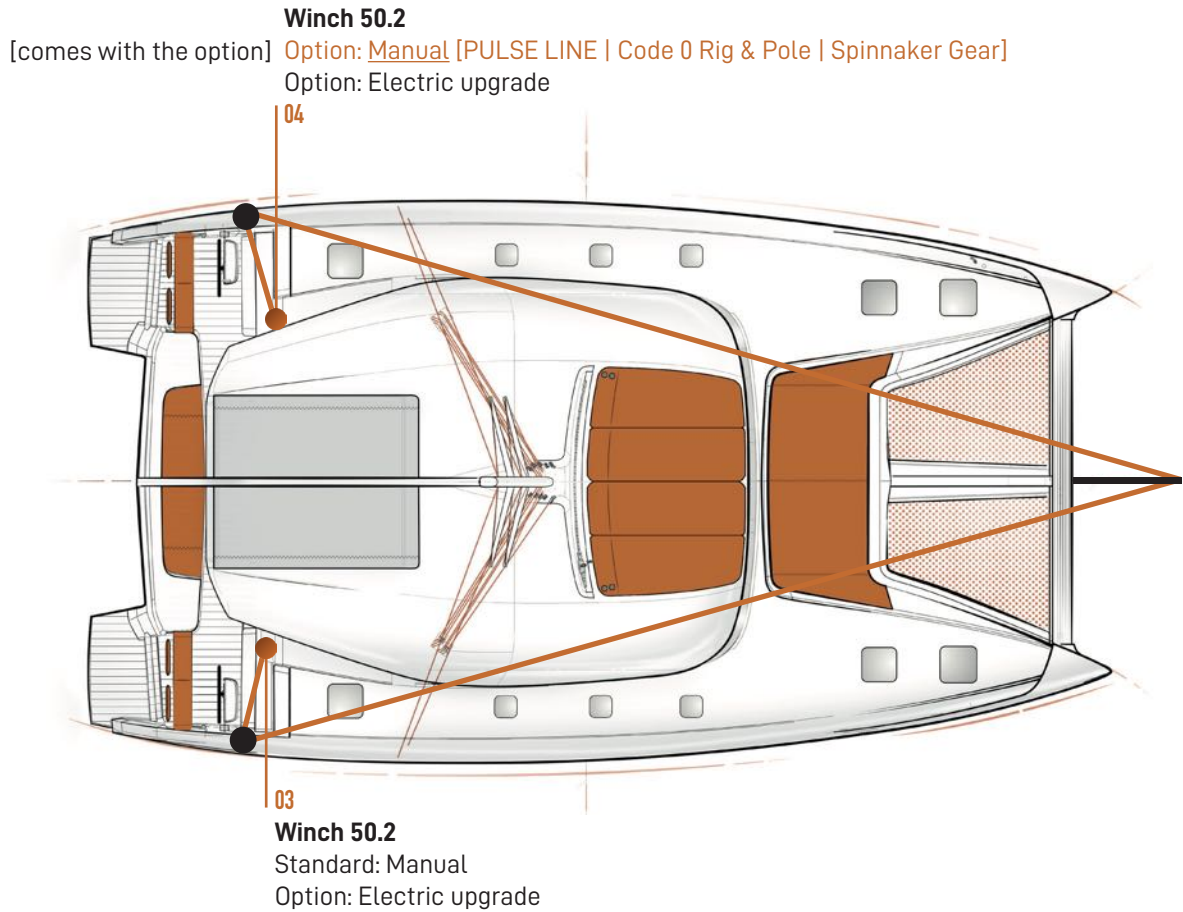

- 03 • Reef 2
- Topping lift
- Main sail halyard
- Jib sheet
- Jib halyard
- Jib furling line
- Code 0 sheet [option]
- Spinnaker sheet [option]

- 04 • Code 0 halyard
- Code 0 sheet
- Spinnaker halyard
- Spinnaker sheet

CODE 0 RIG AND POLE & FURLER

This option includes the following rigging:

A. Code 0 sheets rig

- Port Code 0 sheet
- Starboard Code 0 sheet
- 2 blocks with swivel – Black Magic, Ø 100 Harken® [Port and Starboard]

B. Code 0 halyard rig

- Mast foot block
- Roof block Rutgerson® - [Port]
- Deck block Rutgerson® - [Port]
- Jammer on portside Spinlock® - [Port]
- Code 0 halyard

C. Manual winch on portside + ropes storage

D. Ropes storage [Port]

Modification of port step for ropes storage fitting
Full length step in standard. Smaller step in option.

E. Code 0 furler

F. Pole

[Details and pictures on the following pages]

Please note, this option not include the sail.

CODE 0 RIG AND POLE & FURLER

A. Code 0 sheets rig

Block on starboard and port

Quantity: 2

Brand: HARKEN®

Model: IN3246 - Black Magic Single 100 mm



CODE 0 RIG AND POLE & FURLER

B. Code 0 halyard rig

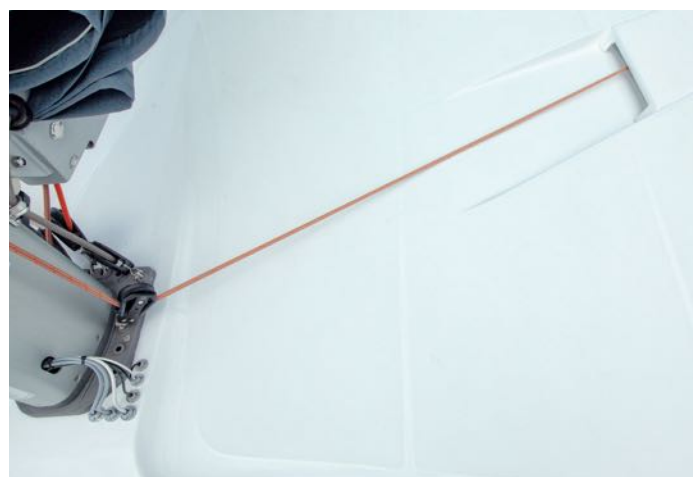

Mast foot block - [Port]
Code 0 halyard- [Port]

Roof foot block Rutgerson® - [Port]

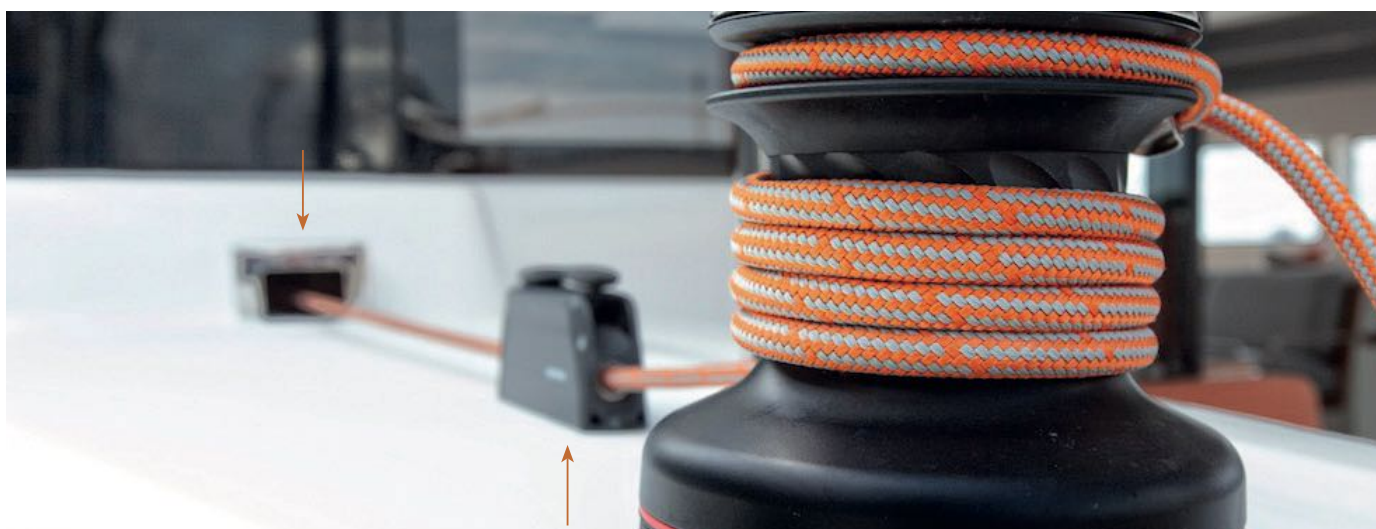

Deck foot block Rutgerson® - [Port]
Jammer Spinlock® - [Port]

CODE 0 RIG AND POLE & FURLER

02

SAILING EXPERIENCE

RIGGING AND SAILS

C. Manual winch on portside



Winch 50.2 STA HARKEN® comes with ropes storage.

[This photo includes the electrical upgrade option]

D. Ropes storage



CODE 0 RIG AND POLE & FURLER

E. Code 0 furler

Facnor® FX+4500 Cliq



F. Pole

[1,500 mm]

ASYMMETRICAL SPINNAKER GEAR

Winch 50.2

[comes with the option] Option: Manual [PULSE LINE | Code 0 Rig & Pole | Spinnaker Gear]

Option: Electric upgrade

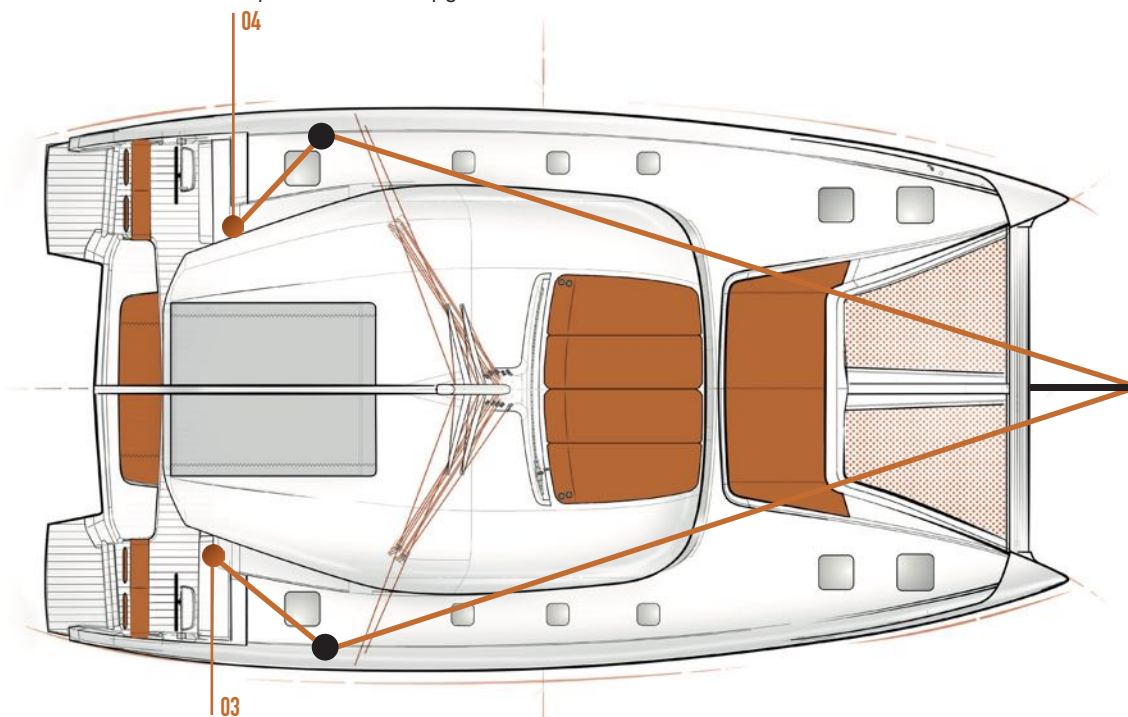

03

Winch 50.2

Standard: Manual

Option: Electric upgrade

- 03 • Reef 2
- Topping lift
- Main sail halyard
- Jib sheet
- Jib halyard
- Jib furling line
- Code 0 sheet [option]
- Spinnaker sheet [option]

- 04 • Code 0 halyard
- Code 0 sheet
- Spinnaker halyard
- Spinnaker sheet

ASYMMETRICAL SPINNAKER GEAR

This option includes the following rigging:

A. Code 0 sheets rig

- Port Code 0 sheet
- Starboard Code 0 sheet
- 2 blocks with swivel – Black Magic, Ø 100 HARKEN® [Port and Starboard]

B. Code 0 halyard rig

- Mast foot block
- Roof block Rutgerson® - [Port]
- Deck block Rutgerson® - [Port]
- Jammer on portside Spinlock® - [Port]
- Code 0 halyard

C. Manual winch on portside + ropes storage

D. Ropes storage [Port]

Modification of port step for ropes storage fitting
Full length step in standard. Smaller step in option.

E. Pole

[Details and pictures on the following pages]

Please note, this option not include the sail.

ASYMMETRICAL SPINNAKER GEAR

A. Spinnaker sheets rig

Block on starboard and port

Quantity: 2

Brand: HARKEN®

Model: IN3246 - Black Magic Single 100 mm



ASYMMETRICAL SPINNAKER GEAR

B. Spinnaker halyard rig

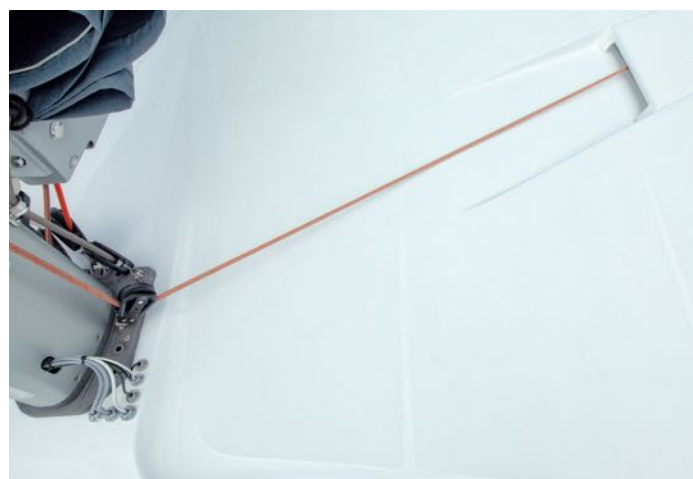

Mast foot block - [Port]
Spinnaker halyard- [Port]

Roof foot block Rutgerson® - [Port]



Deck foot block Rutgerson® - [Port]
Jammer Spinlock® - [Port]

ASYMMETRICAL SPINNAKER GEAR

02 SAILING EXPERIENCE

RIGGING AND SAILS

C. Manual winch on portside



Winch 50.2 STA HARKEN® comes with ropes storage.

[This photo includes the electrical upgrade option]

D. Ropes storage



ASYMMETRICAL SPINNAKER GEAR

02

SAILING EXPERIENCE

RIGGING AND SAILS

E. Pole
[2,000 mm]



CODE 0 IN MYLAR

02

SAILING EXPERIENCE

RIGGING AND SAILS

AVAILABLE FOR **STANDARD SAIL PLAN AND PULSE LINE SAIL PLAN**



Mylar is a plastic sheet made from the resin Polyethylene Terephthalate. It is laminated into sailcloth and provides high tensile strength, dimensional stability, and transparency

This option includes the sail only

CODE 0 sail surface

Standard: 117 m² | 1,259 sq ft

PULSE LINE: 127 m² | 1,367 sq ft



ASYMMETRICAL SPINNAKER WITH SOCKET



[non-contractual sail : exclusive design for launch]

This option includes :

- 1 sail: asymmetrical spinnaker
- 2 sheets
- 1 socket

SPINNAKER sail surface

245 m² | 2,636 sq ft



[Incidence Sails - Customisation](#)

ALUMINUM CANOE BOOM WITH COVER



The option includes :

- Aluminium canoe boom [Brand: SPARCRAFT]
- Cover



[Photo without cover]

Color: Charcoal grey
Sunbrella® SUNTT 5049 152



[Canoe boom on photo]



Color: Charcoal grey
Sunbrella® SUNTT 5049 152

RAYMARINE ELECTRONIC UPGRADE PACK

[SAIL AWAY Pack mandatory]

A. AFT HELM STATIONS

This option includes :

Raymarine



AXIOM 7" on photo.
[Helm station evolution starting from 15#007]

STARBOARD [Main helm station]:

- Upgrade: **AXIOM 9" touch screen** multifonction display in lieu of i70s as per SAIL AWAY Pack
- As per SAIL AWAY Pack: **p70s Autopilot** control heads with color display
- **Support and USB tablet** charger



[Helm station evolution starting from 15#007]

PORT:

[Additional GRP console]

- **i70s Multifunction instrument display** with color display high definition and user interface Lighthouse III
- As per SAIL AWAY Pack: **p70s Autopilot** control heads with color display
- **Support and USB tablet** charger

RAYMARINE ELECTRONIC UPGRADE PACK

[SAIL AWAY Pack mandatory]

A. AFT HELM STATIONS

SAIL AWAY

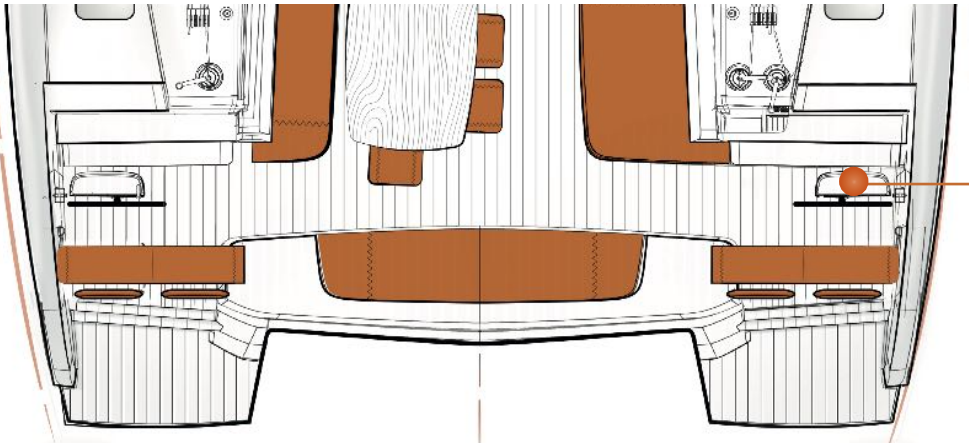

p70s



i70s

RAYMARINE ELECTRONIC UPGRADE PACK

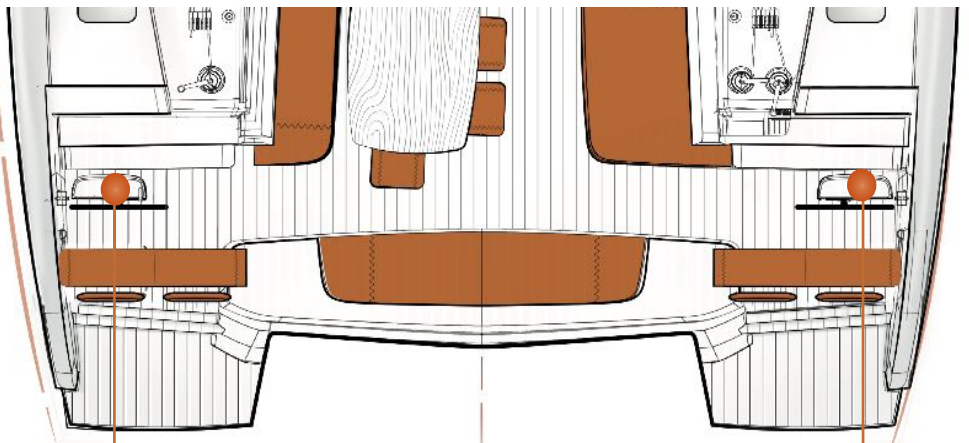

p70s
Model: E70331



i70s
Model: E70330



Brand: ROKK
Model: Mini universal
tablet kit



Axiom 9"
Model: E70366



p70s
Model: E70331



Brand: ROKK
Model: Mini universal
tablet kit

RAYMARINE ELECTRONIC UPGRADE PACK

[SAIL AWAY Pack mandatory]

B. SALON



[leather no longer available]

This option includes :

- **Support and USB tablet charger**

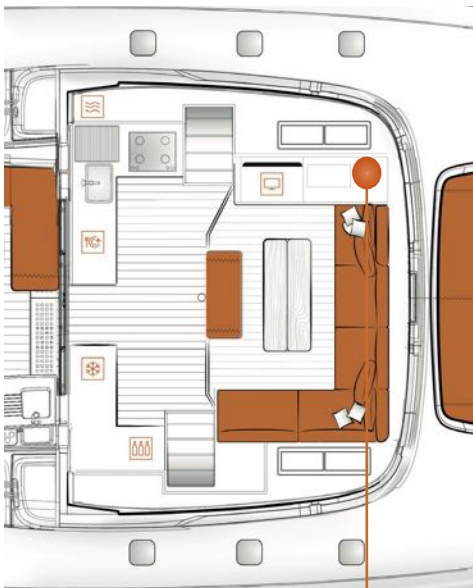

Brand: ROKK
Model: Mini universal
tablet kit

UPGRADE FOR AXIOM 12" DISPLAY

[Raymarine pack upgrade mandatory]



AXIOM 7" on photo.
[Helm station evolution starting from 15#007]

This option includes :

STARBOARD [Main helm station]:

Upgrade: **AXIOM 12" touch screen** multifonction display wifi in lieu of AXIOM 9" display

[RAYMARINE Electronics upgrade Mandatory]

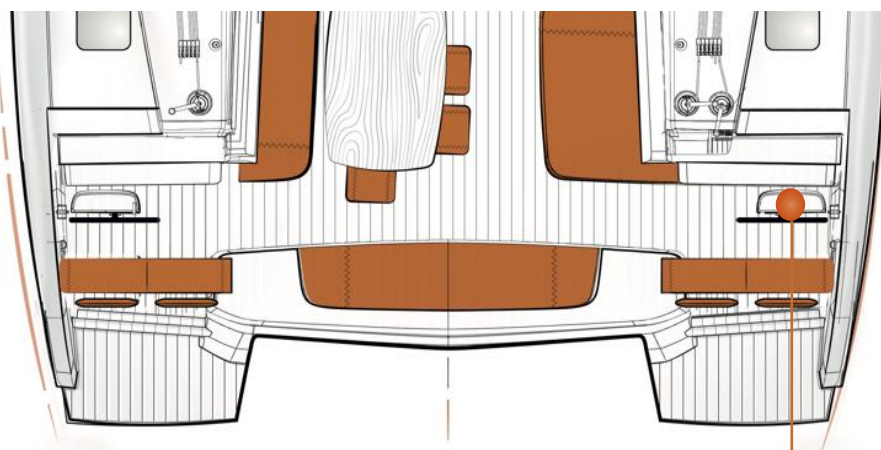



Axiom 12"
Model : E70368



AIS 700 RAYMARINE TRANSCEIVER WITH ANTENNA COUPLING



[AIS700]

AIS700 Class B Transceiver with integrated antenna splitter [Model: E70476]

Key features:

- Full transmit and receive AIS
- Latest SO-TDMA networking
- Built-in antenna splitter
- NMEA2000, NMEA0183, PC and SeaTalking compatible
- Software or hardware switchable Silent Mode

RAYMARINE RADAR 4G QUANTUM Q24D DOPPLER



[QUANTUM 2 CHIRP RADAR 24 MN]

Raymarine Quantum 2 Radar 18" with Doppler collision avoidance technology [Model: E70498]
The option includes stainless steel protection.

Key features:

- Doppler moving target display allows for superior situational awareness at-a-glance
- Fully automatic MARPA target tracking, along with manual MARPA mode
- Adjustable TrueTrails target history shows the motion history of moving contacts
- CHIRP Pulse Compression detects contacts as close as 18-feet for zero-visibility navigation
- 24-mile range for early detection of traffic, navigation aids, landfall and weather
- Immediate awareness – Quantum starts up and is ready to go in seconds
- Superior interference rejection eliminates noise from other radars
- Simplified installation with Wi-Fi or thin wire network connectivity
- Easy upgrade – Quantum 2 fits the same bolt pattern as other Raymarine scanners
- Low power consumption for extended battery life under sail

RAYMARINE REALVISION SOUNDER



Brand: RAYMARINE
Model: **RV-200** Bronze All-In-One Through Hull Transducer [A80465]

Easily identifies structures and locate fish with the life-like clarity of RealVision 3D™ sonar

Maximum depth:
3D: 91,5 m | 300'2"
DownVision: 183 m | 600'4"
Port & Starboard: 91,5 m | 300'2"
Conical: 274 m | 898'11"

Beam width [L|H]:
3D: 180° | Down: 60° | Conical: 25°



[RAYMARINE RV-200]

LOCATION ON BOARD

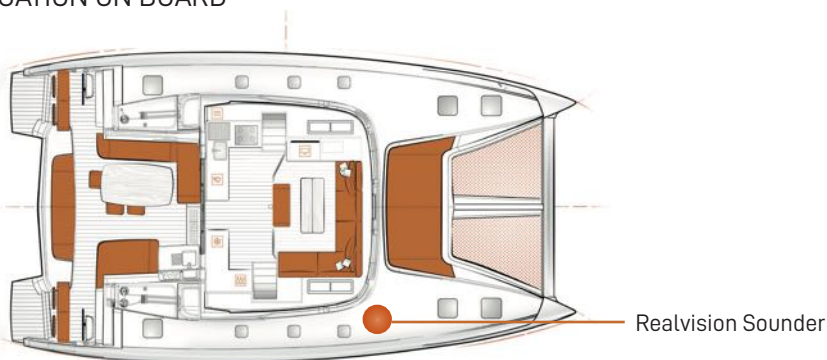

RAYMARINE PILOTE SMART CONTROLLER

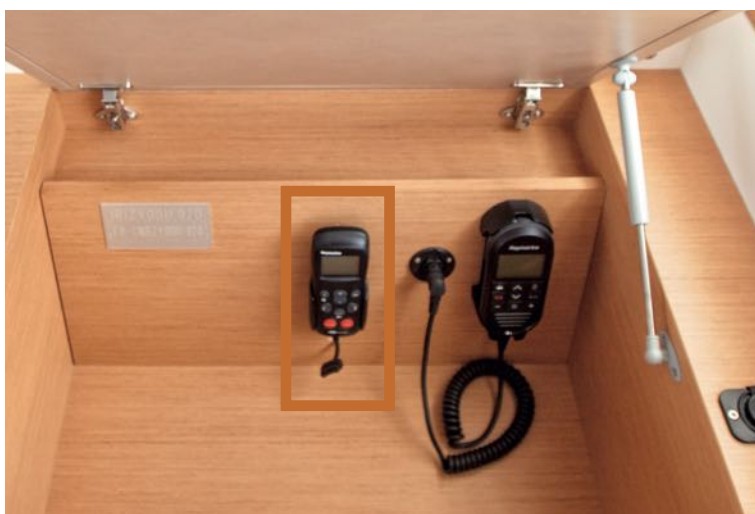

The Raymarine SeaTalk autopilot comes with the wireless SmartController [Model: E15023]

Key Features:

- User-definable pages
- Keylock security
- Backlit buttons
- Display local and system alarms
- Wireless instrument repeater
- Wireless full-function autopilot controller

Raymarine

LOCATION ON BOARD

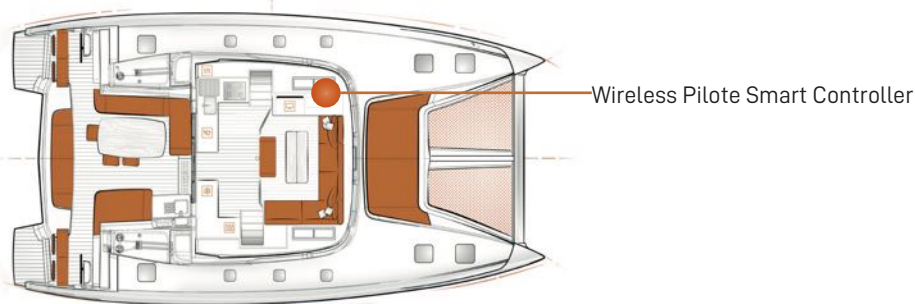

VHF RAYMARINE SINGLE HANDSET



VHF Ray90 ASN combined with active speaker [Raymarine model: A80543]. and wireless station [Raymarine model: A80540]. Model: E70492

Key Features:

- Black box, multi-station capable VHF radio
- Built-in loudhailer and fog signal generator
- Optional external GPS
- Simple NMEA2000 and NMEA0183 Networking

Raymarine

LOCATION ON BOARD

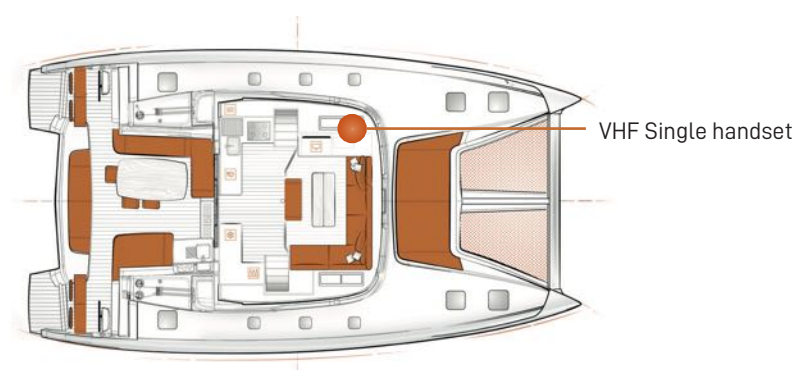

2ND WIRELESS HANDSET FOR VHF RAYMARINE



[Steering wheel no longer available | Helm station evolution starting from 15#007]

Wireless hub carries both data and audio to and from your wireless handset stations
[VHF Ray90 ASN]

Key Features:

- Waterproof construction
- Oversized LCD and rubberized keypads
- Built-in lithium ion rechargeable battery
- Inductive charging technology
- Wireless base station pairs to active speaker
- Handset features smart locator alarm activate alarm from hub



Raymarine

LOCATION ON BOARD

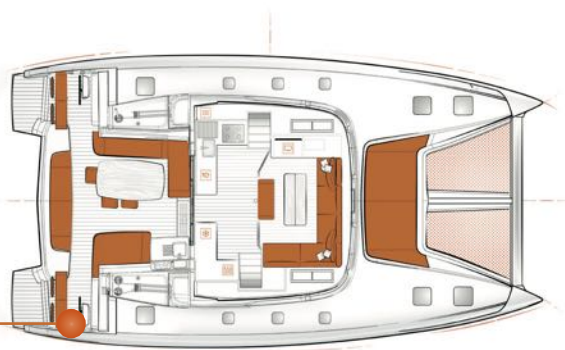

Extra wireless VHF

03

OUTSIDE EXPERIENCE

- Sliding top on roof
- Aft cockpit + transoms in natural teak
- Athermic curtains on roof windows
- Windlass remote control at helm station
- 2nd swim ladder with 2nd hot/cold cockpit shower
- Textile lifelines
- Pulpits with composite seats and forward lifelines
- Boarding ladder
- Cockpit fridge 80L
- Ice maker in cockpit
- Pair of stainless steel davits
- Extra for electric winch for davits [Aft portside]
- Outboard engine bracket
- Folding carbon gangplank with cover
- Hydraulic platform with remote
- PULSE LINE steering wheels
- PULSE LINE hull decoration
- Textile storage on forward net
- Spotlights in aft beam
- Underwater spot lights

OUTSIDE UPHOLSTERIES

- Enclosures with windows for aft cockpit
- Biminis on helm stations with windows [Port and Stbd]
- Forward deck sun awning [canopee]
- Additional double helm seat [Port]
- Aft cockpit cushions
- Aft cockpit sunbathing
- Forward cockpit cushions
- Roof sunbathing

SLIDING TOP ON ROOF

03 OUTSIDE EXPERIENCE



Sliding top opened



Sliding top closed

SLIDING TOP ON ROOF

03 OUTSIDE EXPERIENCE



Color: Cadet Grey
Sunbrella® SUNTT 5530 152

Manual sliding roof. Replaces the standard GRP roof.

! Warning !

Do not walk on the sliding roof area, it is not meant to support the weight of a person

Dimensions:

2,700 L x 2,550 W mm | 8'10" x 8'4"

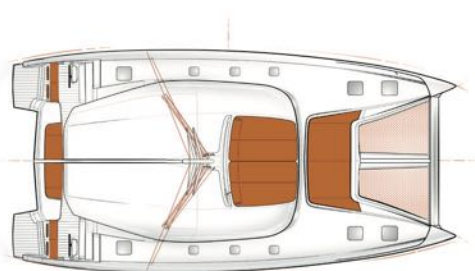

[Standard]

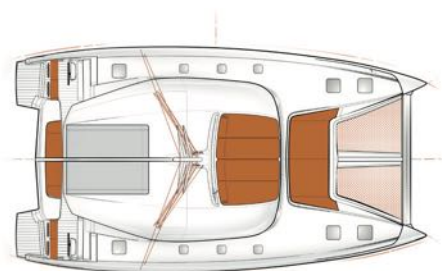

[Option]

AFT COCKPIT + TRANSOMS IN NATURAL TEAK



[Option]
Natural teak with grey caulking

Covers the aft cockpit floor and both transoms.



[Photos onboard EXCESS 11]

[Standard: white GRP floor]

LOCATION ON BOARD

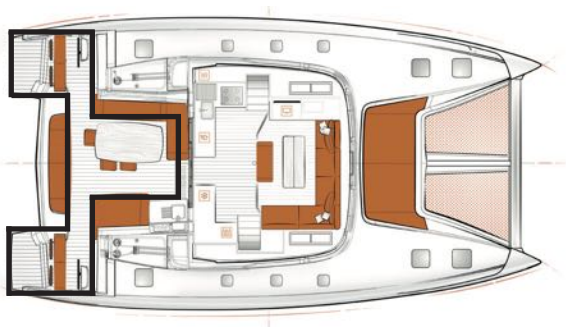

ATHERMIC CURTAINS ON ROOF WINDOWS



Athermic exterior curtains on 360° roof windows.

- Clip-on pressure system
- Central and lateral openings from inside

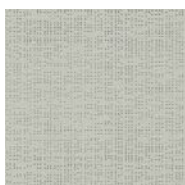

Color: Grey
FERRARI® Soltis Perfrom 92
2171 GALET

WINDLASS REMOTE CONTROL AT HELM STATION



[Steering wheel no longer available] [Helm station evolution starting from 15#007]



The option includes:

- Windlass remote control from starboard helm station
- A chain counter

The option completes standard remote control in front storage compartment.

LOCATION ON BOARD

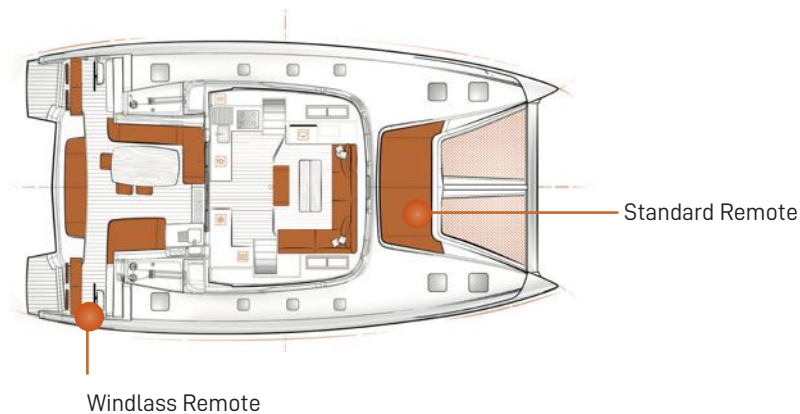

2ND SWIM LADDER WITH 2ND HOT/COLD COCKPIT SHOWER



[Teak no longer available]



On portside, the option includes:

- Additional hot/cold water cockpit shower
- Additional swim ladder

Standard: Cockpit shower and swim ladder on starboard.

LOCATION ON BOARD

Additional swim ladder
+ cockpit shower

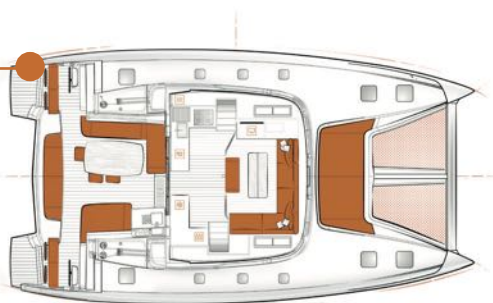

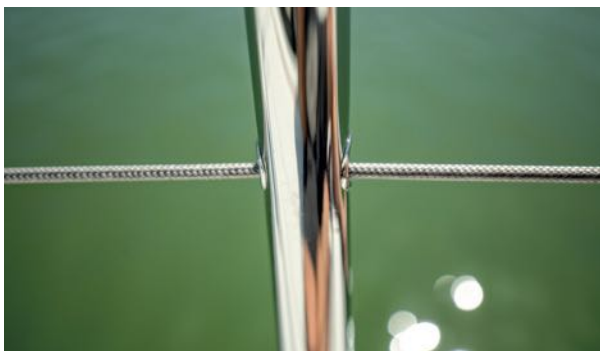
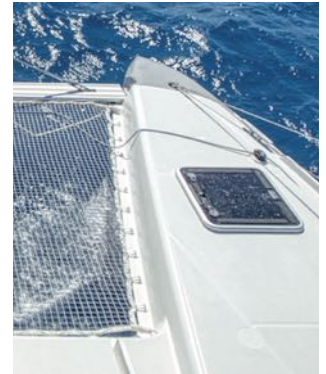

1

Textile lifelines

2

- The pad-eye is part of the option. By selecting the textile lifelines you get also a pad-eye.

Textile lifelines are available as part of the PULSE LINE Pack or as an option.

The customized lifelines are **fluorescent at night for safer night cruising.**

Brand: LANCELIN
Material: Fiber
Color: Orange & Grey

[Standard: Stainless steel lifelines & pad-eye]

PULPITS WITH COMPOSITE SEATS AND FORWARD LIFELINES



[Photo onboard EXCESS 11]

This option includes 2 forward pulpits [port and starboard] with composite seats.

The option is available with **stainless steel or textile** lifelines.



[Standard]

LOCATION ON BOARD

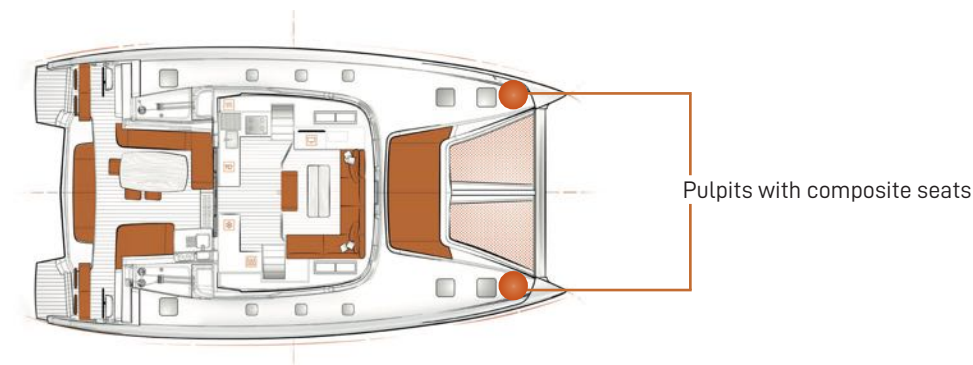

BOARDING LADDER

03 OUTSIDE EXPERIENCE



Stainless steel removable boarding ladder.

Quantity : 1

2 possible locations: either on port or starboard

[Opening lifelines in SAIL AWAY Pack]

[Photos onboard EXCESS 12]



COCKPIT FRIDGE 80L



[Color upholstery no longer available]



12V refrigerator located in the aft cockpit.
80 L | 21 US gal

Brand: Dometic®
Model: Coolmatic CRX 80

[Dometic - Fridge](#)

LOCATION ON BOARD

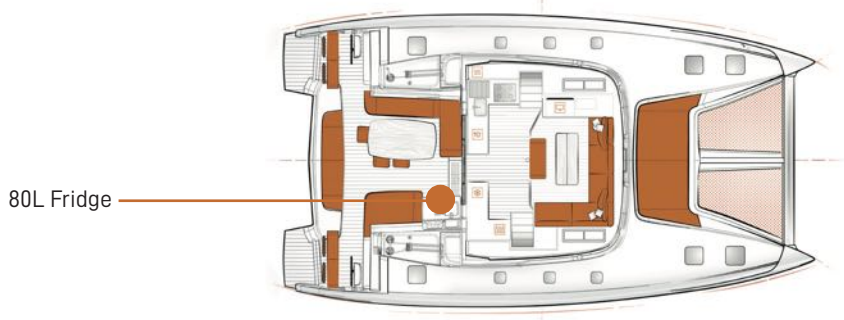

ICE MAKER IN COCKPIT



Production capacity : 8kg per day
Available in 230V and 120V.
Freezer compartment to keep ice cubes frozen.

Brand: Webasto®
Model: IceDrink

[Webasto - Ice Maker](#)

This option replaces standard storages.

LOCATION ON BOARD

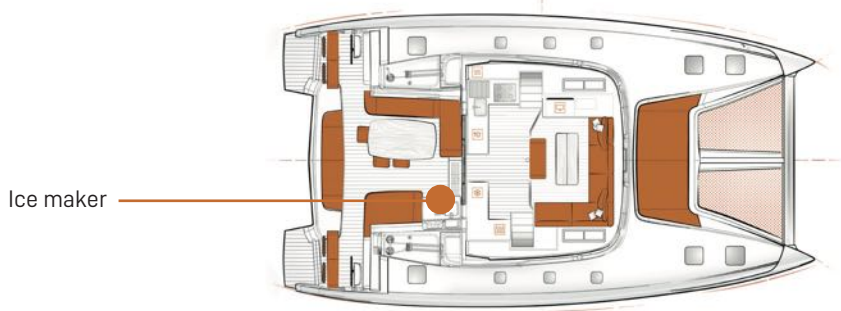

PAIR OF STAINLESS STEEL DAVITS



Load max. weight: 250 Kg | 551 lbs
Dinghy max. length 3,4 m | 11'1"



NEW
Upgrade for stainless steel davits option: foam protections.

LOCATION ON BOARD

Dinghy lifting system

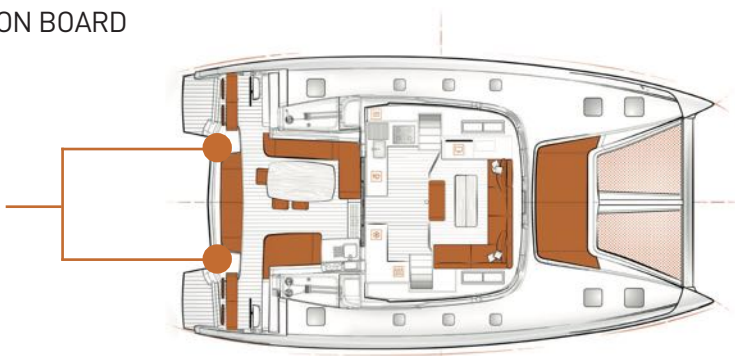

EXTRA FOR ELECTRIC WINCH FOR DAVITS



Electrical upgrade for manual winch for davits [portside]

Brand: HARKEN®
Model: 40.2 STEA

LOCATION ON BOARD

Electric winch for davits

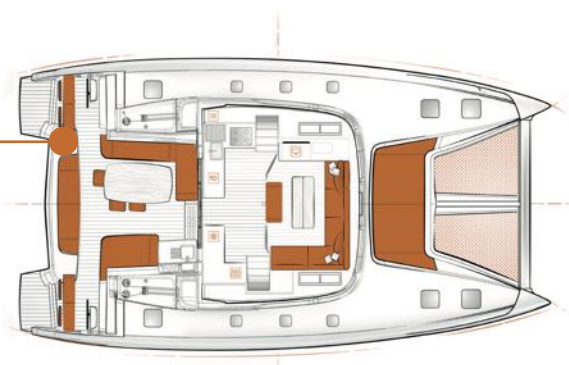

OUTBOARD ENGINE BRACKET



Stainless steel bracket [aft portside]

Maximum power: 10HP engine

LOCATION ON BOARD

Outboard engine bracket

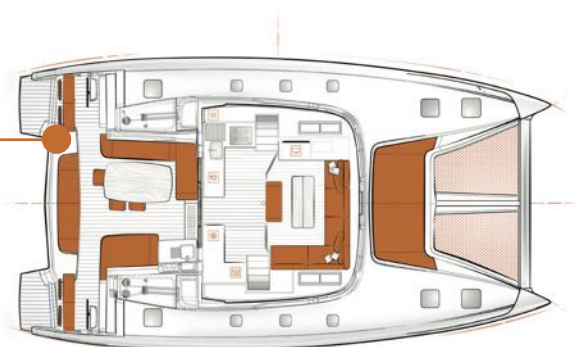

FOLDING CARBON GANGPLANK WITH COVER

03

OUTSIDE EXPERIENCE



The option includes :

- Gangplank
- Cover
- 2 sockets

Gangplank dimensions

Open: 2,600 x 350 mm | 8'6" x 1'1"

Closed: 1,300 x 350 mm | 4'3" x 1'1"

HYDRAULIC PLATFORM WITH REMOTE

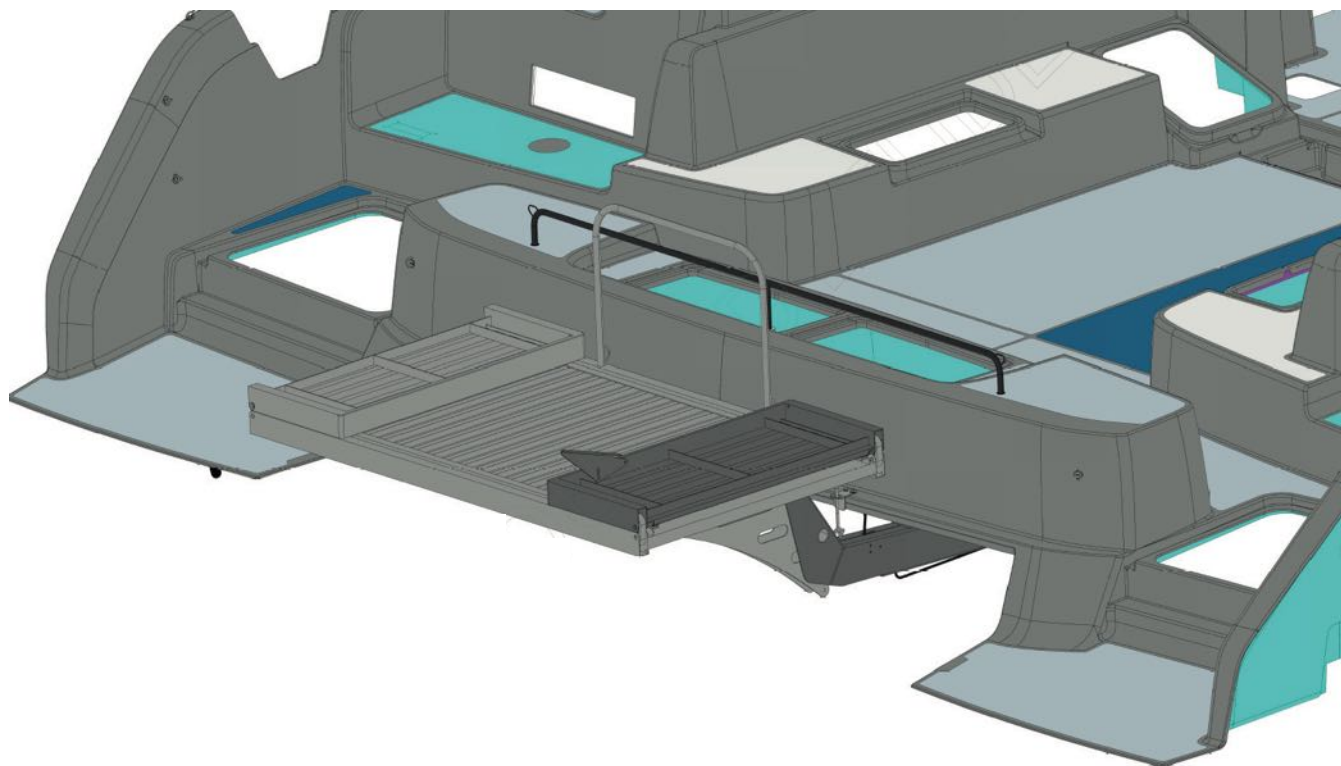

Submersible swimming platform.

The option includes :

- 12 V Hydraulic unit [700 W]
- Wired **remote control** located in the port aft beam locker
- 2 Wireless remote control

Brand: TENDERLIFT

Platform dimensions

Open: 3,470 x 1,350 mm | 11'4" x 4'5"

Closed: 2,460 x 1,350 mm | 8'0" x 4'5"

Dinghy

Max. weight: 250 Kg | 551 lbs

Max. length 3,4 x 10 m | 11'4" x 32'9"

PULSE LINE STEERING WHEELS

03

OUTSIDE EXPERIENCE

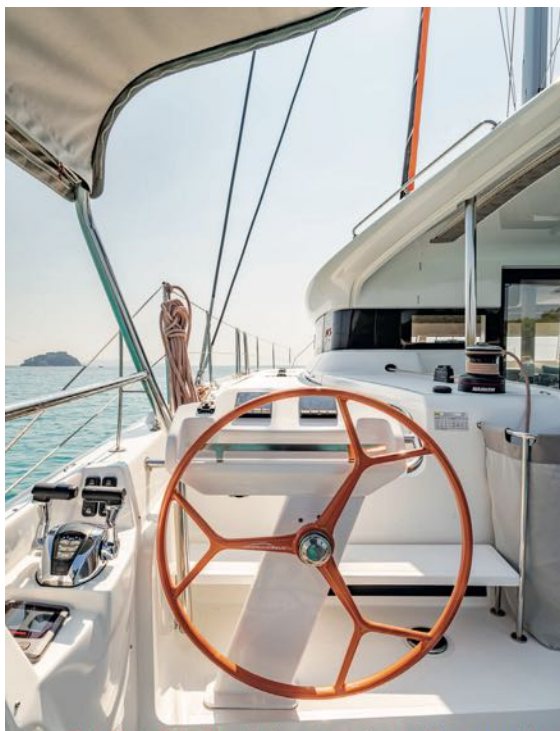

OPTION



This option replaces the standard s/s steering wheels
Upgrade for both helm stations.

Brand; CARBONAUTICA
Material: Composite
Color: Orange

[Carbonautica - Steering wheel](#)

STANDARD



[Photo onboard EXCESS 12]



Material: Stainless steel & leather
Color: Grey

PULSE LINE HULL DECORATION

03 OUTSIDE EXPERIENCE

We've created a distinction between the standard line and the sportier PULSE LINE, while maintaining the same spirit. The inspiration came from the logo, a sporty and elegant wake, fluid and dynamic, taken up in an immoderate way in its PULSE LINE version. Isabelle's interest in typography made the process almost natural. The combined lines at the back of the hulls highlight the turn of the bilges in a marked and legible manner.



HULL DECORATION BY ISABELLE KELLER



"I have sailed a lot, racing, with a crew and I have shared the life of a professional sailor for a long time. I have experienced ocean racing and great adventures like the Transats and the Vendée Globe, from the inside. And then, on a simpler level, I have always wanted to live by the sea, overlooking the Atlantic Ocean."
Isabelle Keller, designer of the hull decoration.

TEXTILE STORAGE ON FORWARD NET



[Photo onboard EXCESS 11]

Canvas storage bag on forward trampoline for any storage.

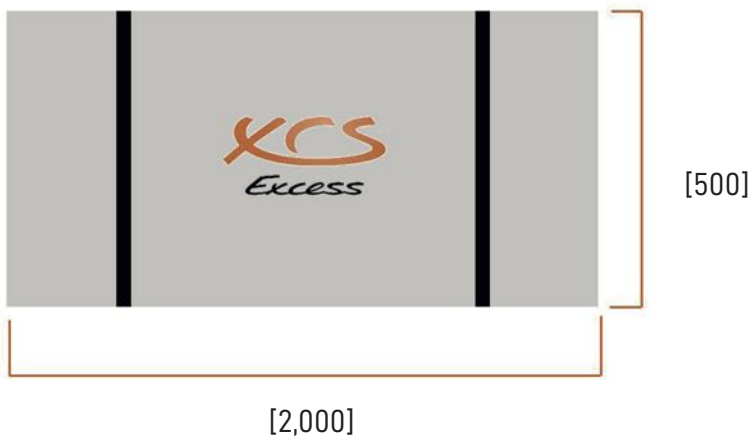

Color: Grey [Light Charcoal]
Fabrics : Weather Max 80

SPOTLIGHTS IN AFT BEAM

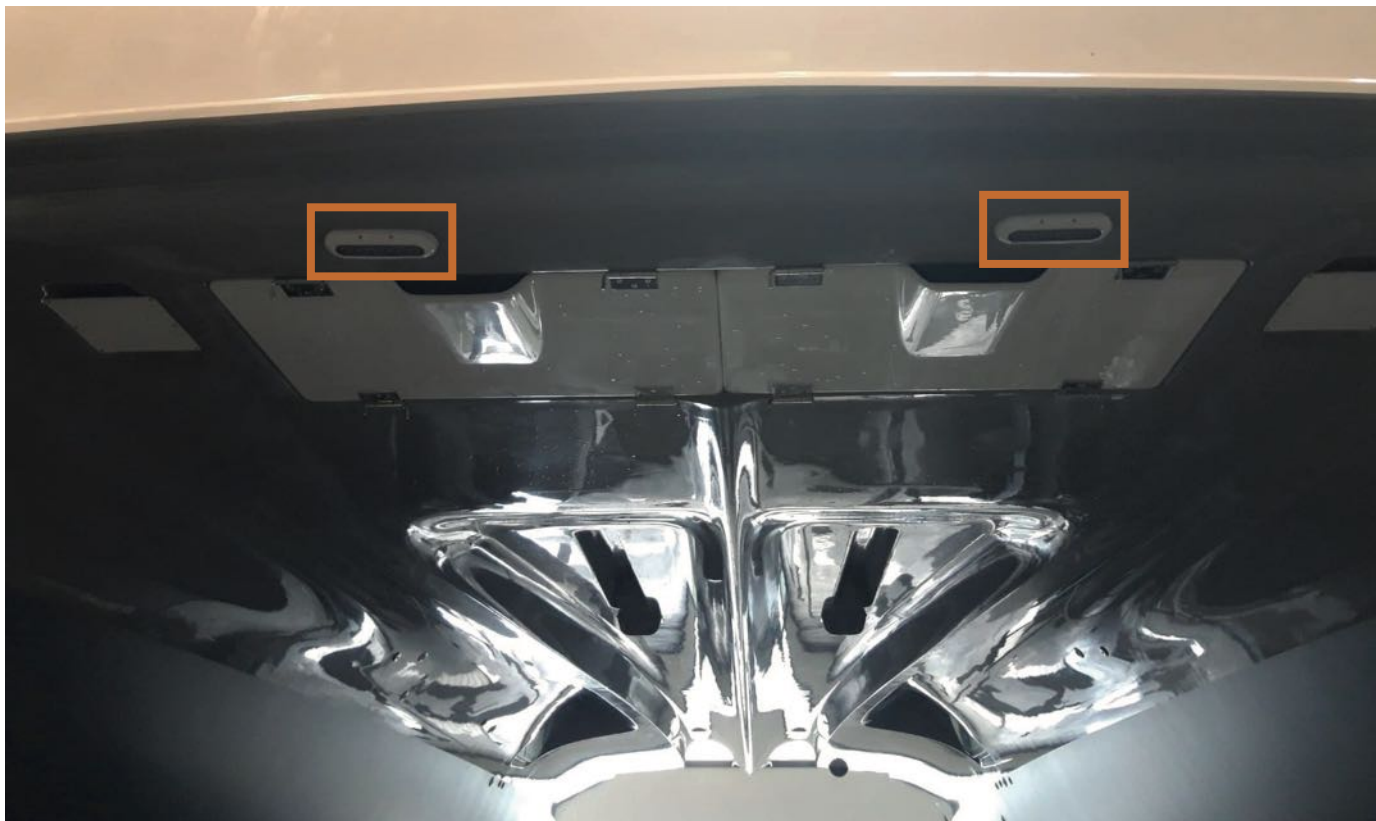

Quantity: 2
Brand: OCEANLED®
Model: X-series X8 12/24V DC - White



Two 12V spot lights mounted in aft beam.
Remote control on standard touch screen located on starboard companion way

LOCATION ON BOARD

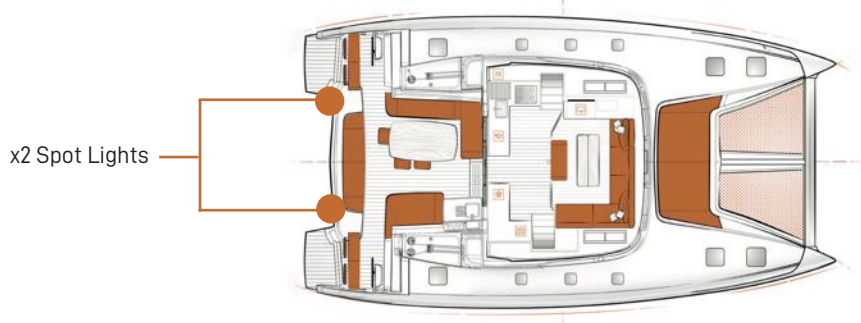

UNDER WATER SPOT LIGHTS [X4]

03

OUTSIDE EXPERIENCE



Quantity: 2 per hull [x4 total]
Brand: AQUALUMA®
Model: Serie 12- Gen 4
Color: Blue

Remote control on standard touch screen located on starboard companion way

LOCATION ON BOARD

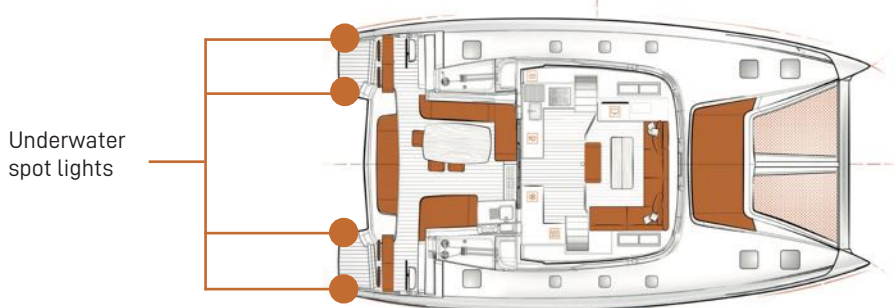

ENCLOSURES WITH WINDOWS FOR AFT COCKPIT



Color: Cadet Grey
Sunbrella® SUNTT 5530 152

Enclosures made in fabric with PVC transparent windows.

The option includes 1 large aft enclosure with 2 doors on each side.

Lateral dedicated storage in the roof with fabric cover.

BIMINIS ON HELM STATIONS WITH WINDOWS [PORT AND STARBOARD]



This option includes :

- **2 biminis** with enclosures and windshield **[port and starboard]**
- Stainless steel structure with canvas top roof
- Additional enclosures with windows on side and aft and windshield
- Dedicated storage bag for each bimin



Color: Cadet Grey
Sunbrella® SUNTT 5530 152

FORWARD DECK SUN AWNING [CANOPEE]



You can maneuver the sun awning from the mast foot. Fitting must be attached to an halyard to move up and down the sun awning.

The sun awning must be attached on cleats and shrouds, never on stanchions or lifelines.



The option includes:

- Sun Awning
- Storage bag [65 L - 12 Kg]
- 1 Halyard
- Spinlock XTS0814/1B on mast



Color: Grey [Light Charcoal]

Fabrics : Weather Max 80

ADDITIONAL DOUBLE HELM SEAT [PORTSIDE]

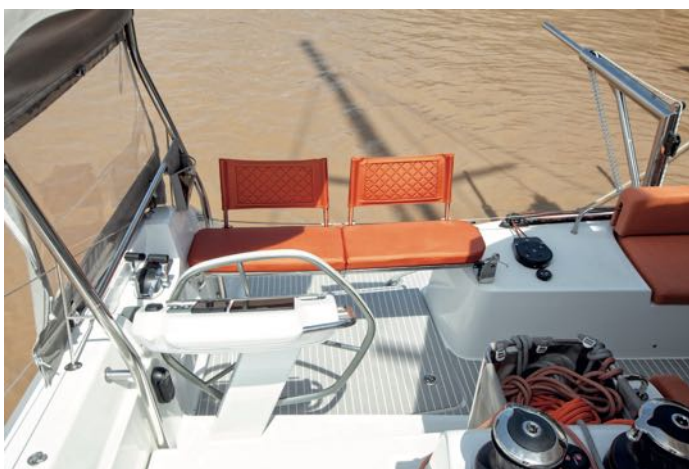

[Color upholstery no longer available]



Double foldable seat on **port** helm station.
Option includes a cover.

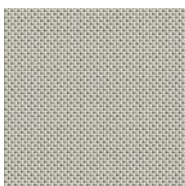

Color: Grey
FERRARI® Batyline Lounge Quartz
7720FR-50932

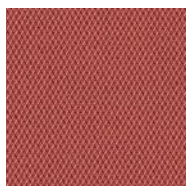

Color: Orange
SUNBRELLA® Mezzo Tigerlily
MEZZ 10222 140

AFT COCKPIT CUSHIONS



The option includes cushions - and upholstery color - for all aft cockpit settees:

- L-shaped sofa on portside
- Starboard bench
- Aft beam settee



Color: Grey
FERRARI® Batyline Lounge Quartz
7720FR-50932



Color: Orange
SUNBRELLA® Mezzo Tigerlily
MEZZ 10222 140

AFT COCKPIT CUSHIONS

03

OUTSIDE EXPERIENCE

UPHOLSTERIES

PORT SOFA

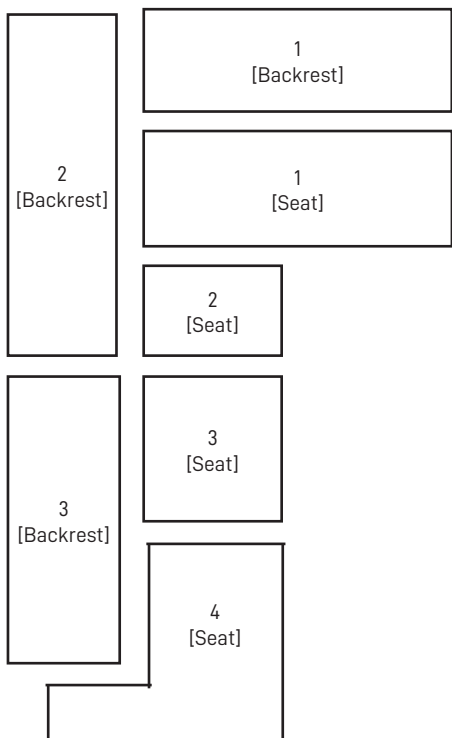

STARBOARD BENCH

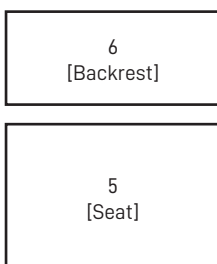

[Color upholstery no longer available]

AFT BEAM



AFT COCKPIT SUNBATHING



[Photo on board EXCESS 12]



Aft bench and modular table transforming into a wide sunpad area.

The option includes:

- 2 table pedestals
- 1 mattress

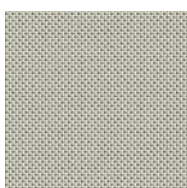

Color: Grey
FERRARI® Batyline Lounge Quartz
7720FR-50932

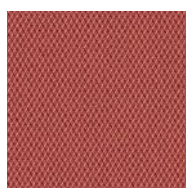

Color: Orange
SUNBRELLA® Mezzo Tigerlily
MEZZ 10222 140

FORWARD COCKPIT CUSHIONS

03

OUTSIDE EXPERIENCE

UPHOLSTERIES



[Ladder no longer available]

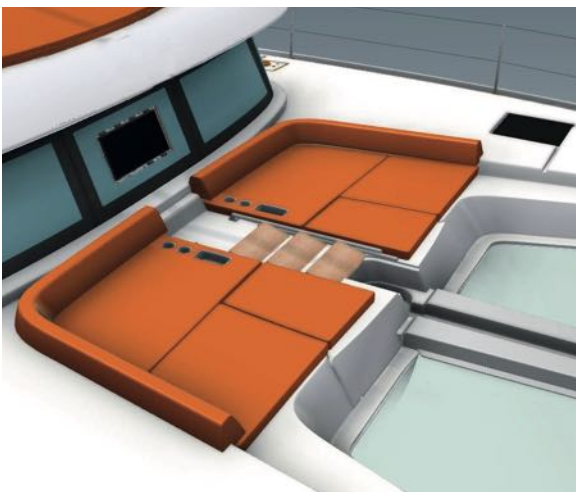

The option includes the upholstery for the forward cockpit:

- Sunbathing mattresses with integrated backrests
- 1 central independent mattress with **integrated cup holders**
- Ladder storage underneath cushions.

Dimensions: 3,200 W x 1,400 H mm | 10'5" x 4'7"

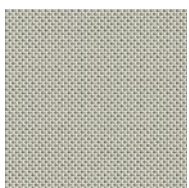

Color: Grey
FERRARI® Batyline Lounge Quartz
7720FR-50932

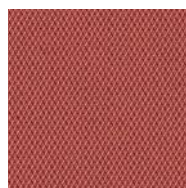

Color: Orange
SUNBRELLA® Mezzo Tigerlily
MEZZ 10222 140

ROOF SUNBATHING

03

OUTSIDE EXPERIENCE

UPHOLSTERIES

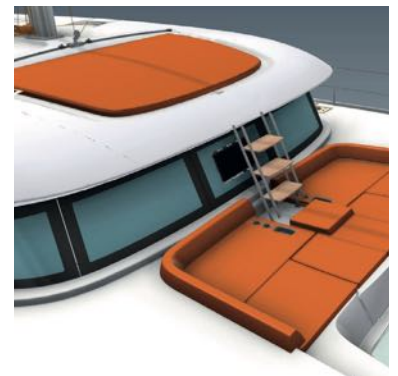

The option includes the upholstery for the roof:

- 4 sunbathing mattresses, located in the roof
- Side of the sunbath integrates **cup holders**

Matresses feature an integrated cover in the back for easy protection.

Dimensions: 2,700 W x 1,950 H mm | 8'10" x 6'4"

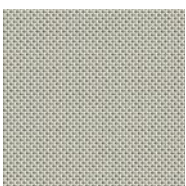

Color: Grey
FERRARI® Batyline Lounge Quartz
7720FR-50932

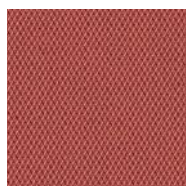

Color: Orange
SUNBRELLA® Mezzo Tigerlily
MEZZ 10222 140

04

TECHNICAL EQUIPMENT

ENGINES

Engines 2 x 80HP [Yanmar 4JH80]

Electric engines throttles at helm stations

Electric bow thruster + batteries + charger

Pair of 3-blades folding propellers

ELECTRICAL CIRCUIT

ONAN genset 11kVA [230V/50Hz] + Cocoon

ONAN genset 7kVA [230V/50Hz] + Cocoon

Gel batteries

Inverter 2kVA

Solar panels on davits

Shaver sockets in heads

WATER CIRCUIT

Additional fresh water tanks 2 x 175 L

Watermaker 100L/H

Grey water tanks 2 x 120 L

Additional black water tanks 3 or 4 x 120 L

Sea water pump

Fresh water dock inlet

Deck wash pump [Sea water / Fresh water]

Fresh water electrical toilets

ENGINES 2X 80 HP [YANMAR 4JH80]

04 TECHNICAL EQUIPMENT ENGINES

The option includes the engine replacement from standard [Yanmar 4JH57 | 2 x 54HP] to **Yanmar 4JH80 SD| 2 x 80HP.**



The optional Yanmar 4JH80 SD| 2 x 80HP comes with fixed propellers 18x15 per standard.

[80 SD folding propellers 18x15]

MOTEUR / engine	YANMAR	4JH80	80 cv	3200 trs/mn
	Inverseur	SD60S	2,23/1	
HELICES / propeller	3-blade folding 18x15 (option)			

CONDITIONS DES ESSAIS	Vent / wind:	knots
Atmospheric conditions	Mer / sea	m

POIDS DU BATEAU / weight	18 400 kg
Carburant / fuel (1l = 0,83 kg)	400 336 kg
Eau / water (litres)	500 500 kg
Equipage / crew	9 675 kg
Sécurité et mouillage / safety equipment	150 kg
Divers / others	400 kg
	20 461 kg

Régime Moteur en Trs/mn Engine rpm	Vitesse moyenne : nœuds Average speed : knots	Consommation moyenne / moteur Fuel consumption / engine	
		L / H	US Gal / H
800	2,55	0,63	0,17
996	3,50	0,83	0,22
1198	4,65	1,15	0,30
1410	5,50	1,68	0,44
1605	5,95	2,20	0,58
1807	6,40	3,08	0,81
2002	6,70	4,00	1,06
2211	7,20	5,25	1,39
2412	7,60	6,80	1,80
2625	8,25	8,80	2,32
2807	8,35	9,98	2,64
2984	8,60	12,35	3,26
3318	8,80	15,75	4,16

Informations non contractuelles.
These informations are not contractuals.

La vitesse moyenne est relevée au GPS / GPS speed
La consommation en fuel est donnée en litre pour 1 moteur / Litre fuel consumption for one engine.

ELECTRIC ENGINES THROTTLES AT HELM STATIONS

Directly fitted on both helm stations [port and starboard], electric engines throttles replaces the standard mechanical throttle [1 on starboard main helm station].

This option includes :



On STARBOARD [Main steering station]

- Engine throttles upgrade : electric in lieu of mechanical in standard.
- Control panel upgrade : A10 Start/Stop panel [one per engine] & YD42 display [one for both engines] in lieu of B25 panel in standard [one per engine]



On PORTSIDE

[Additional GRP support on the side]

- Additional A10 Start/Stop panel [one per engine] & YD 42 display [one for both engines]
- Secondary electric engine throttles

ELECTRIC ENGINES THROTTLES AT HELM STATIONS

04 TECHNICAL EQUIPMENT ENGINES

STANDARD

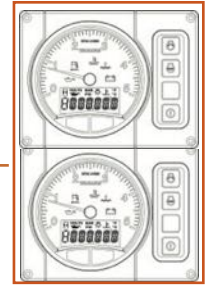
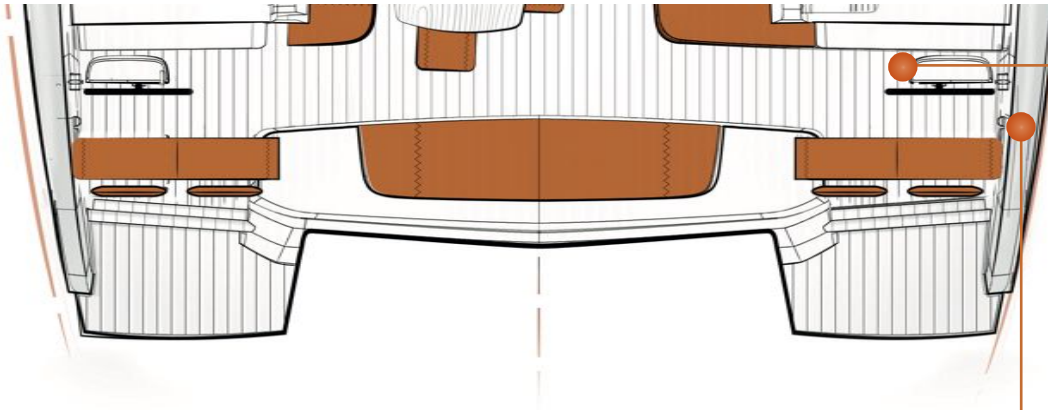

B25 panel



Mecanical throttles Ultraflex® B324

OPTION

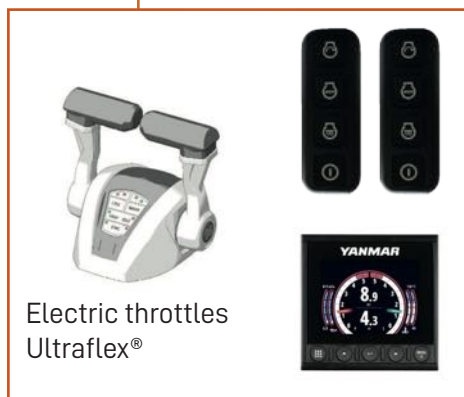
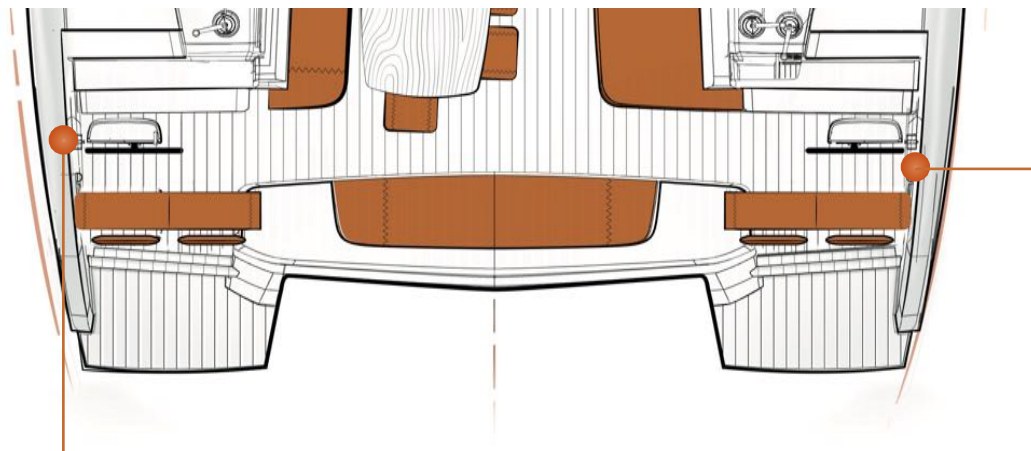

Electric throttles Ultraflex®



A10 start/stop panel A10 start/stop panel

YD 42 display

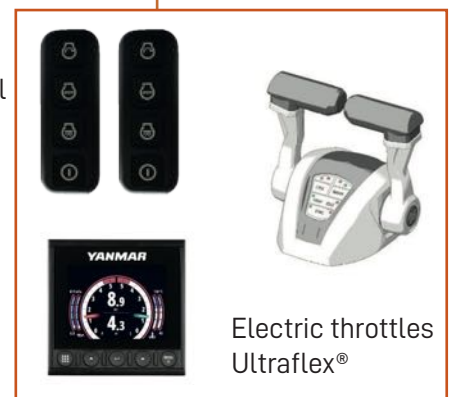

YD 42 display

Electric throttles Ultraflex®

ELECTRIC BOW THRUSTER + BATTERIES + CHARGER

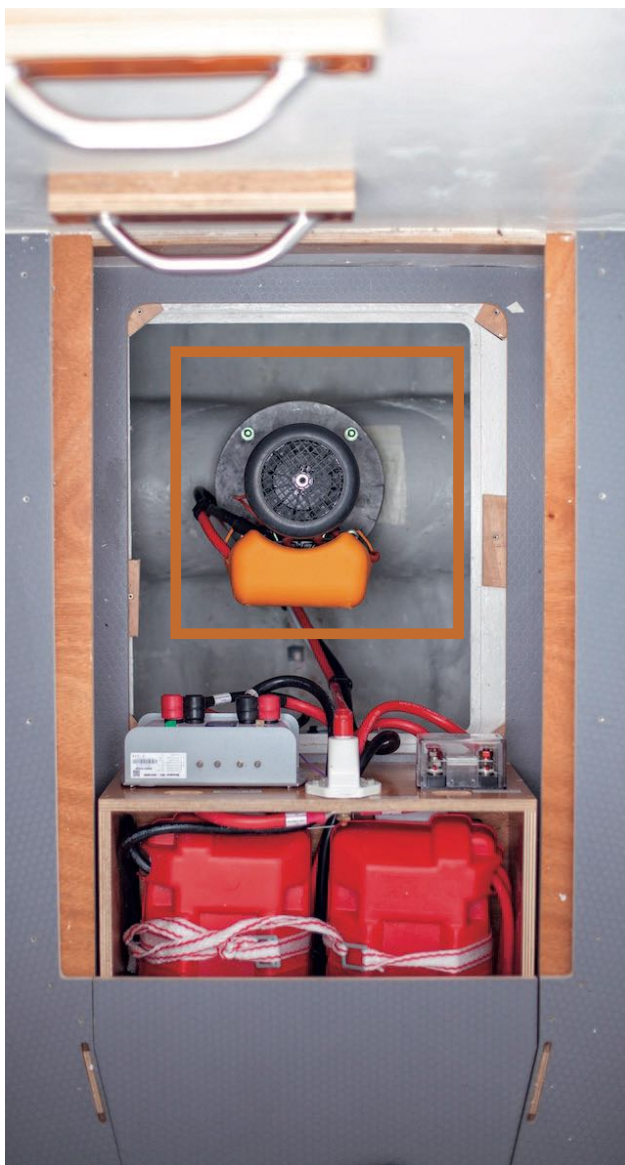

The option includes:

- x1 electric bow thruster*
- x4 dedicated batteries : 12V AGM dual orbital 50A 750A
- x1 dedicated charger : DOLPHIN 12/24V 30A

The bow thruster as well as its batteries, batteries breaker, fuse and charger are located in the port forward peak.

The 12/24 V charger recharges the bow thruster battery bank with 24 V, using the onboard 12 V service battery bank.

Brand: QUICK
Model: 24V 140 KGF

*From EXCESS 15#003
Brand: QUICK
Model: 24V 105 KGF



LOCATION ON BOARD

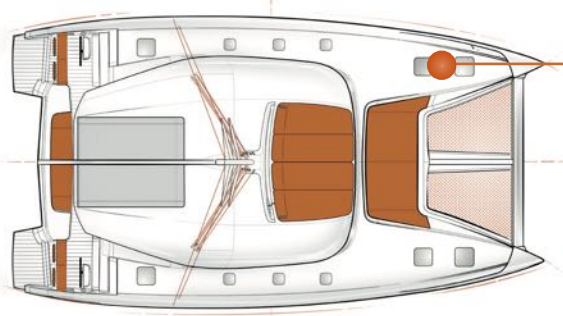

Bow thruster + batteries



Bow thruster is operated directly from the starboard helm station.

PAIR OF 3-BLADES FOLDING PROPELLERS

Replaces 57 HP fixed propellers 18x15 [standard].

Brand : FENWICK
 Model : Flex-o-fold



[57 HP engine option: folding propellers 18x14]

[80 HP engine option: folding propellers 18x15]

MOTEUR / engine **YANMAR** 4JH80 80 cv 3200 trs/mn
 Inverseur SD60S 2,23/1
 HELICES / propeller 3-blade folding 18x15 (option)

CONDITIONS DES ESSAIS Vent / wind: knots
 Atmospheric conditions Mer / sea m

POIDS DU BATEAU / weight **18 400 kg**
 Carburant / fuel (1l = 0,83 kg) 400 336 kg
 Eau / water (litres) 500 500 kg
 Equipage / crew 9 675 kg
 Sécurité et mouillage / safety equipment 150 kg
 Divers / others 400 kg
20 461 kg

Régime Moteur en Trs/mn Engine rpm	Vitesse moyenne : nœuds Average speed : knots	Consommation moyenne / moteur Fuel consumption / engine	
		L / H	US Gal / H
800	2,55	0,63	0,17
996	3,50	0,83	0,22
1198	4,65	1,15	0,30
1410	5,50	1,68	0,44
1605	5,95	2,20	0,58
1807	6,40	3,08	0,81
2002	6,70	4,00	1,06
2211	7,20	5,25	1,39
2412	7,60	6,80	1,80
2625	8,25	8,80	2,32
2807	8,35	9,98	2,64
2984	8,60	12,35	3,26
3318	8,80	15,75	4,16

Informations non contractuelles.
 These informations are not contractual.

La vitesse moyenne est relevée au GPS / GPS speed
 La consommation en fuel est donnée en litre pour 1 moteur / Litre fuel consumption for one engine.

ONAN GENSET 11/7KVA

04

TECHNICAL EQUIPMENT

ELECTRICAL CIRCUIT



[Forward starboard technical compartment]

Comes in original shield which minimizes noise and vibrations.

Brand: CUMMINS ONAN

Dedicated 12V 50A battery.
Works with both fuel tanks.
Tug in aft port cabin to select port tank or starboard tank.

Control panel on generator.
Start/Stop from main touch screen and Onan panel control located on starboard companion way.

230V 50HZ 7KVA
[120V 60HZ 9KVA]

230V 50HZ 11KVA
[120V 60HZ 13.5KVA]



[Technical compartment on starboard companionway]

LOCATION ON BOARD

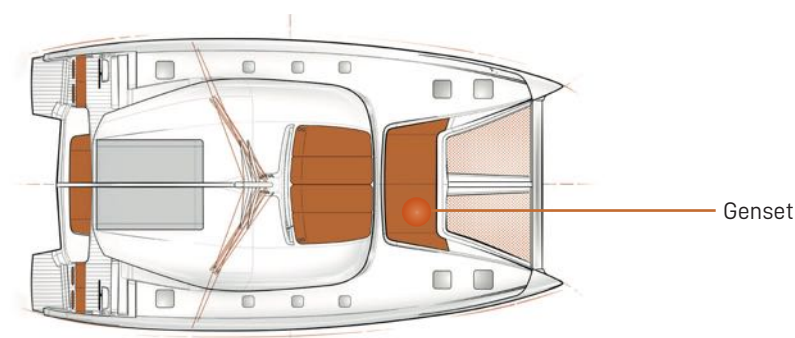

GEL BATTERIES

GEL BATTERIES option includes 6x GEL batteries [6 x 120 A]

The option replaces the standard.

EXCESS 15 comes with 3+3 x 140 A | Acid batteries as standard.

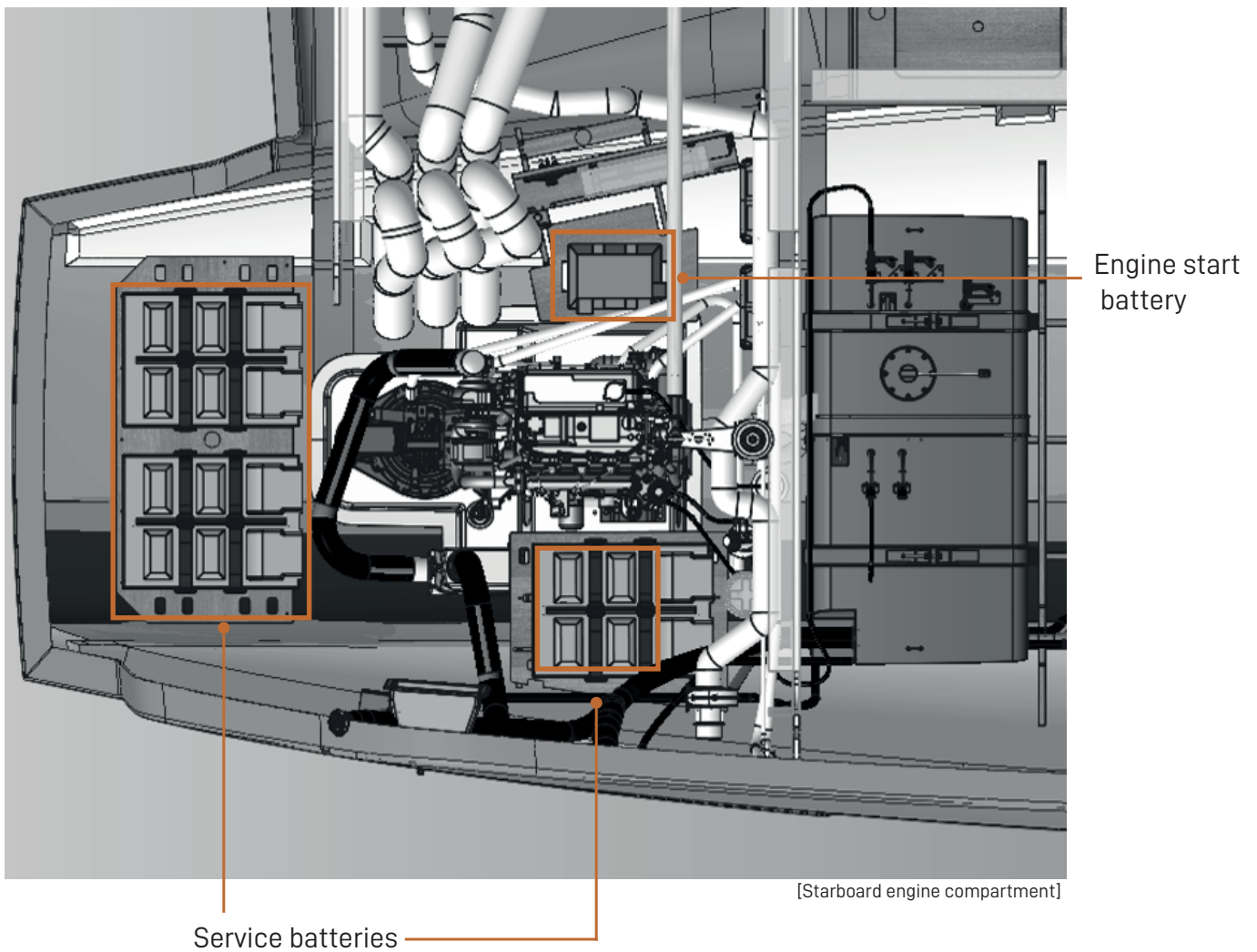

LOCATION ON BOARD

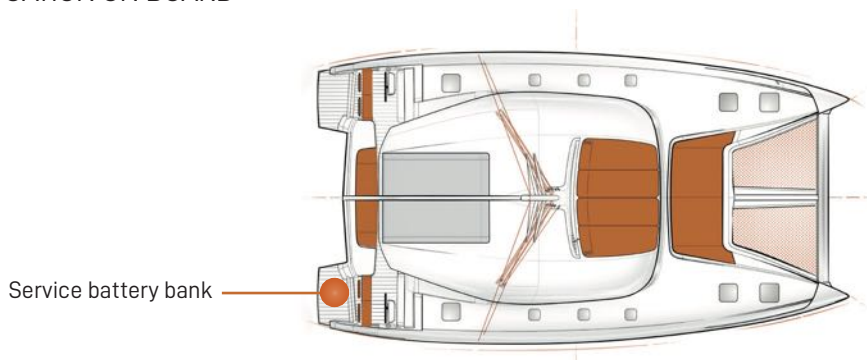

INVERTER 2 KVA



Brand: MASTERVOLT
Model: AC Master 12|2000 [Ref: 28512000]
Power: 2,000 VA

Available in 230V and 120V.

Automatic selection when shore power [SAIL AWAY Pack compulsory] is detected from the system. Power switches automatically from the inverter to the shore power.

LOCATION ON BOARD

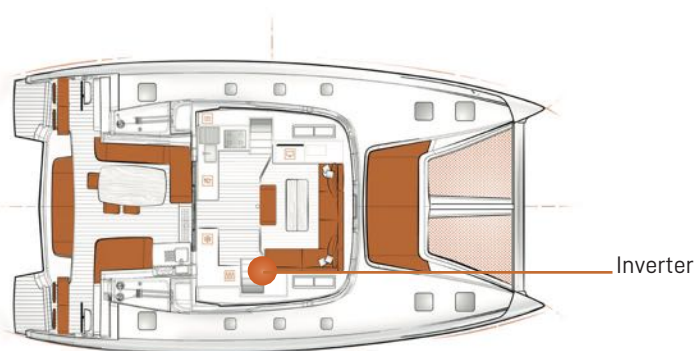

SOLAR PANELS ON DAVITS

04 TECHNICAL EQUIPMENT

ELECTRICAL CIRCUIT

The option includes 4 panels of 120 W each **[Total: 460 W]**



[Photo onboard EXCESS 12]



Brand : SOLARA
Quantity : 4
Rated output : 120W
Panel dimension : [L x B x H] : 1,250 x 543 x 3mm
Weight [per unit] : 4.4 kg
Cell dimension : 125 x 125 mm
Cell technology : mono crystalline with backcontact

SHAVER SOCKETS IN HEADS

The option includes:

- Wiring harness
- Protections
- Shaver sockets

Located in the upper lockers.

1 x 220V shaver sockets per head.
[Not available for 6-cabin version]

LOCATION ON BOARD

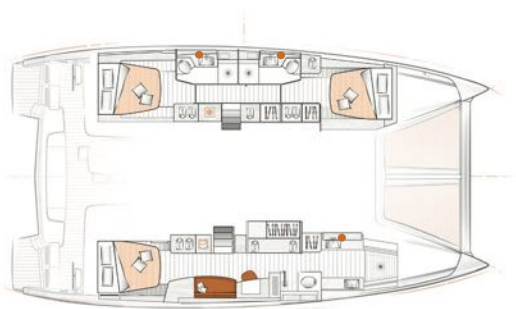

[3-cabin version]

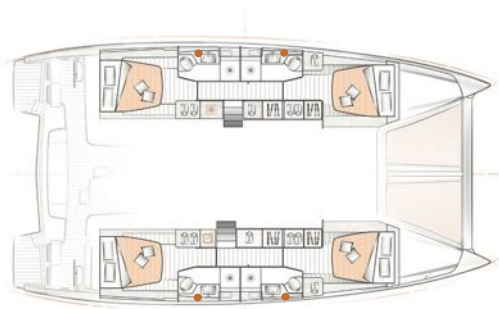

[4-cabin version]

120V / 60 HZ NORTH AMERICAN SPECIFICATION

This option includes all the changes on standard electrical equipments from 230V/50Hz to 120V/60Hz [Technical drawing on following page]

Main changes detailed underneath:

1 | Shore Power | 120V - 60Hz
32A shore power [SAIL AWAY] replaced by 50A shore power

2 | Sockets:
[Cabin and technical compartment]

Cabin
Standard socket

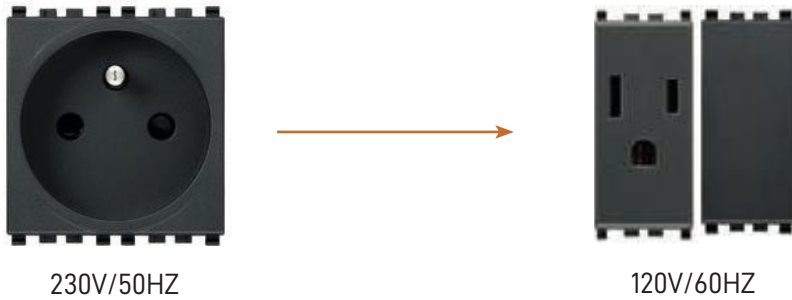

Socket with USB

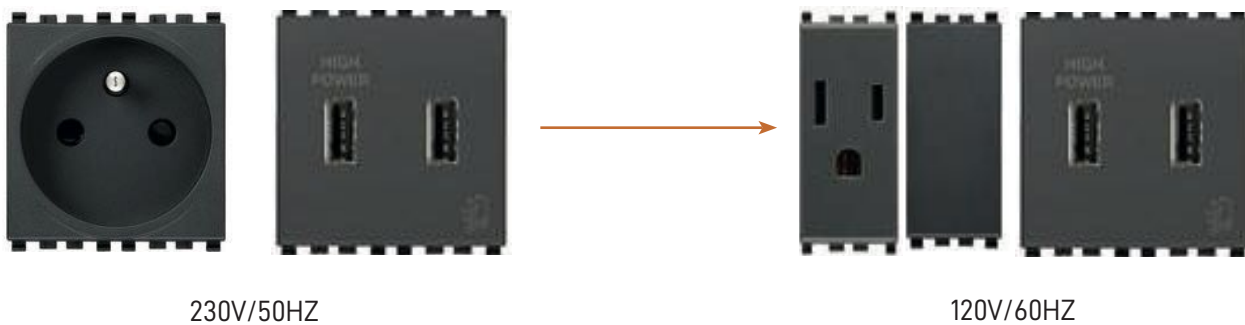

3 | Gas circuit:
Gas solenoid valve with indicator light and electrical switch

120V / 60 HZ NORTH AMERICAN SPECIFICATION

120V/60Hz Electrical circuit [complete circuit= standard + option]

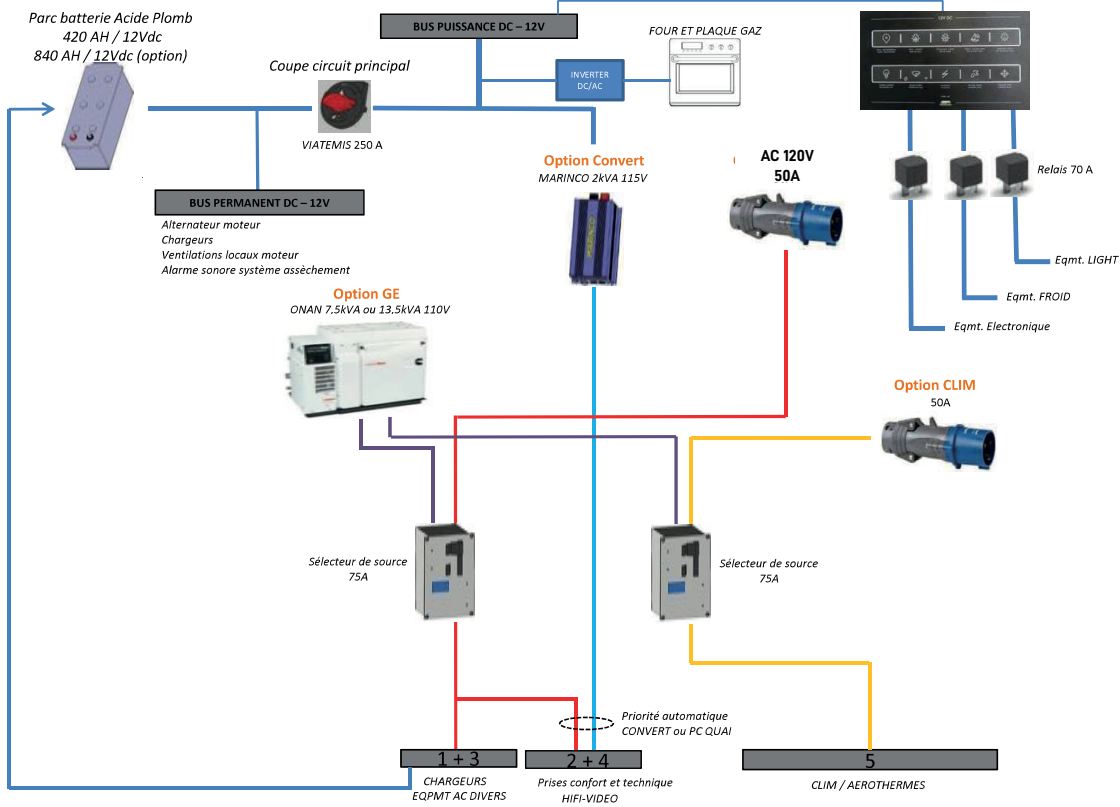

230V/50Hz Electrical circuit [complete circuit= standard + option]

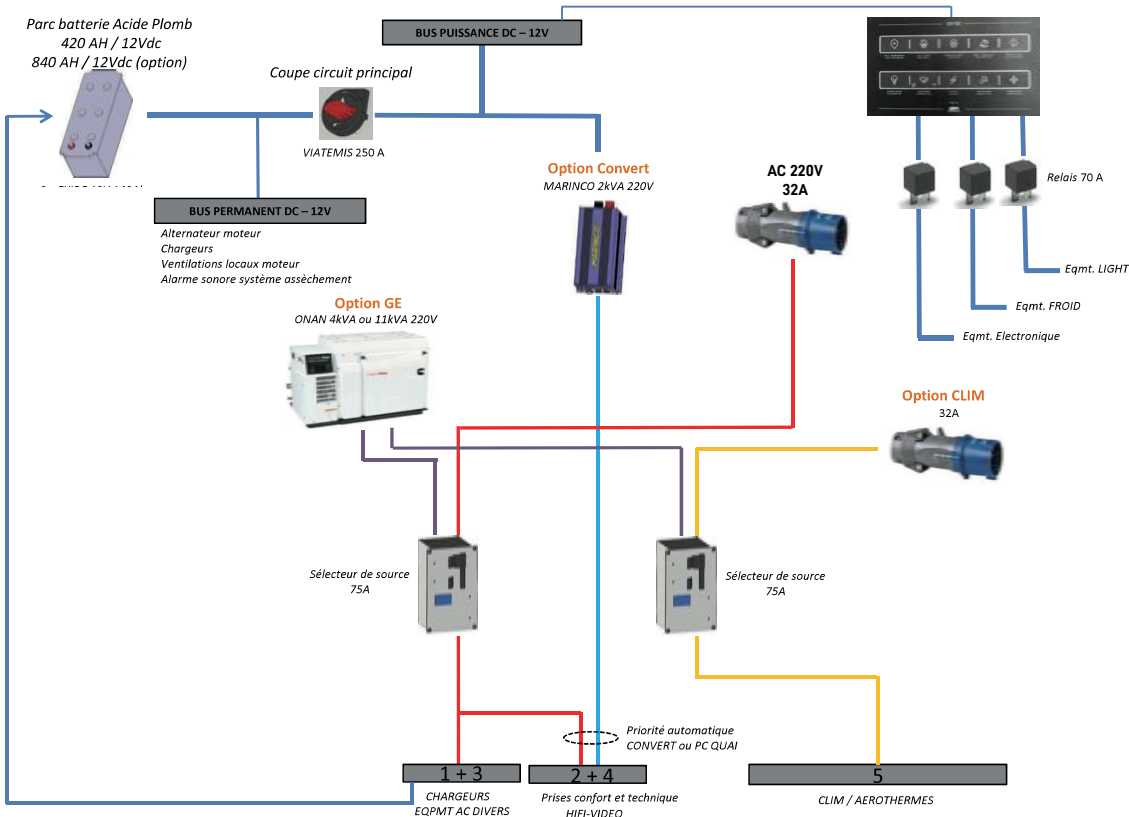

ADDITIONAL FRESH WATER TANKS 2 X 175 L



The option includes x2 extra fresh water tank **on port & starboard** [2 x 175 L | 2 x 46 US Gal]

Total capacity [standard + option]: 830 L | 220 US Gal

LOCATION ON BOARD

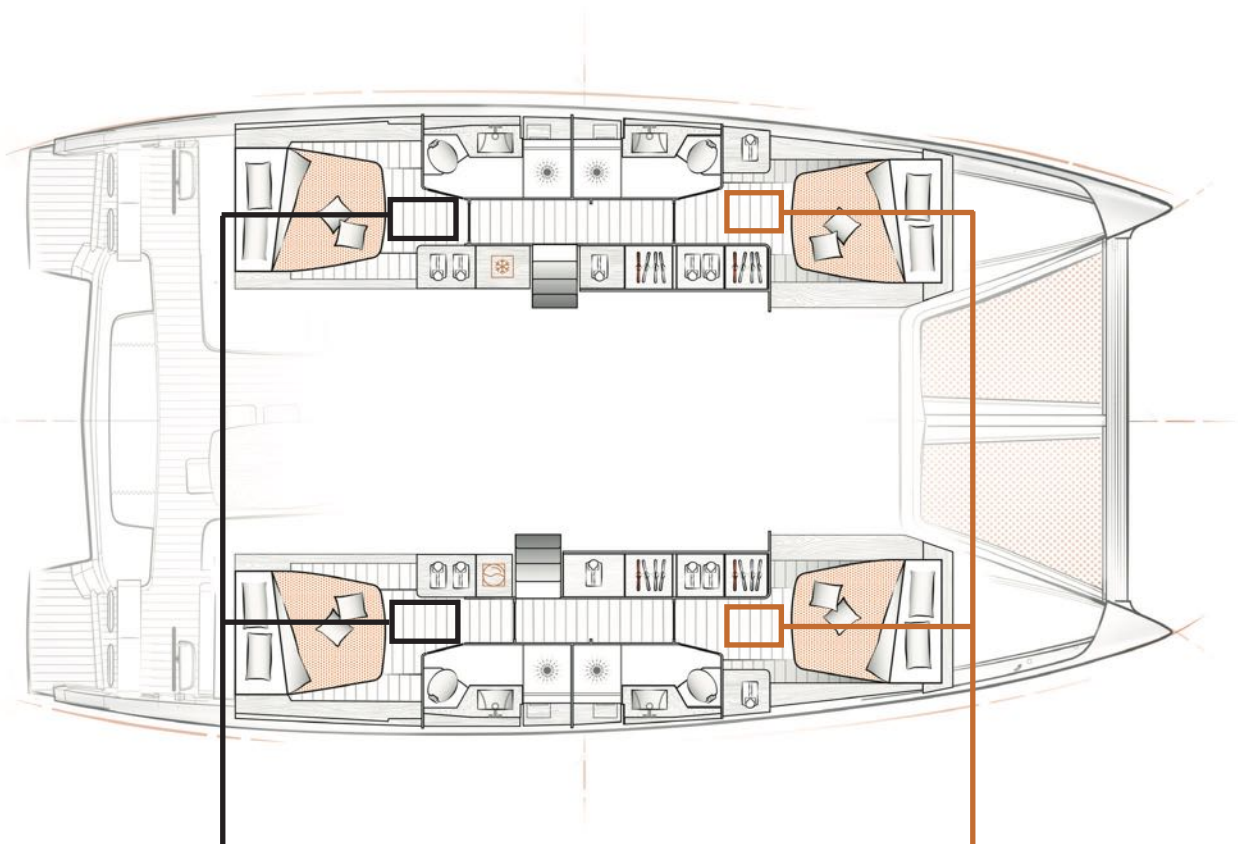

Standard: fresh water tanks
2 x 240 L [2 x 63 US Gal]

Option: Additional fresh water tanks
2 x 175 L [2 x 46 US Gal]

WATERMAKER 100L/H

04 TECHNICAL EQUIPMENT

WATER CIRCUIT



Located underneath the floor on aft port cabin.
Access from a removable hatch on the floor.

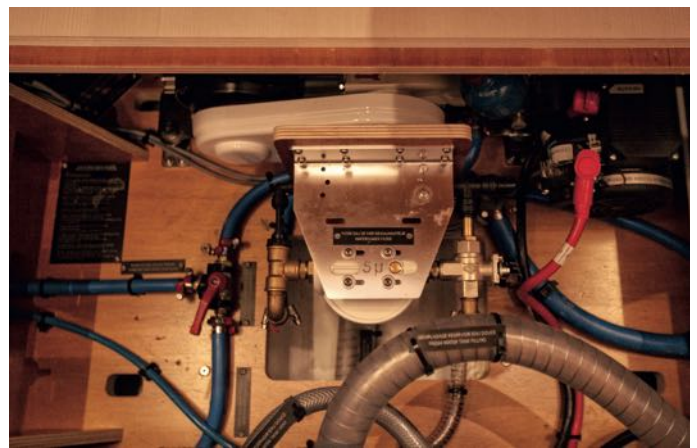

Brand: DESSALATOR
Model: Dessal 100 L / H - 12/230V [26 US Gal]

Three way valve allows you to choose the tank port or starboard

LOCATION ON BOARD

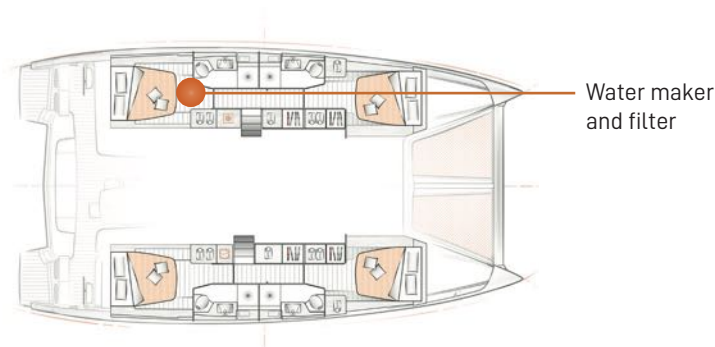

Watermaker control panel

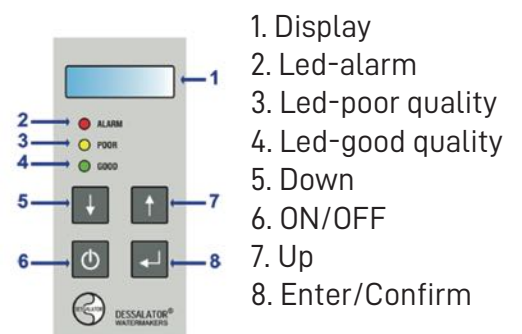

This panel is connected via an RJ cable, located in aft port cabin

GREY WATER TANKS 2 X 120 L

[Available only on 3 & 4-cabin versions]



The option includes 2 x 120 L | 2 x 32 US gal GREY water tanks, located underneath the floor on starboard and port companionways. Tanks accessible through a removable hatch on the floor.

[Total capacity: 240 L | 63 US gal]

[Not compatible with additional black water tanks options]

Equipment connected to the tanks :

- Standard : Heads [sink & shower], galley sink and cockpit sink
- Option : Dishwasher, washer-dryer, toilet, shower and sink in stbd bow compartment

All wastewaters are differently connected and collected into the tanks:

- Cockpit/galley sinks/dishwasher : by gravity
- Heads : automatic and independent electric pump

Central units underneath the shower are all connected to the tanks via an electric pump.

- Washer-dryer : automatic and independent electrical pump
- Forepeak in starboard bow compartment : automatic and independent electric pump

Tanks are exhausted by the deck vacuum or direct to the sea via an electric pump.

Pump control panel is located in the starboard companionway.

Depending on the navigation area and thanks to three 3 way-valves, all wastewaters can also be evacuated directly to sea without being collected into the tanks.

LOCATION ON BOARD

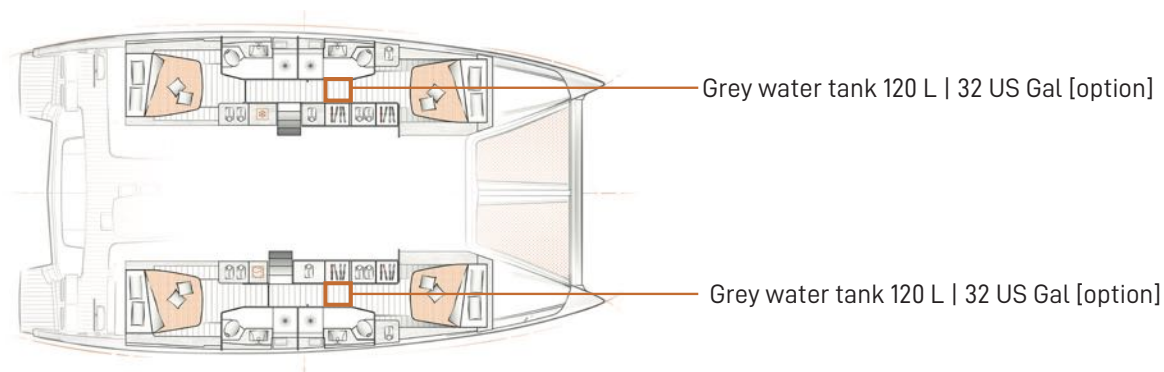

ADDITIONAL BLACK WATER TANKS 3 OR 4 X 120 L

[Available only on 3 & 4-cabin versions]



The option includes 1 or 2 additional 120L | 2 x 32 US gal black water tanks, located underneath the floor on starboard and port companionways.

Tanks accessible through a removable hatch on the floor.

[Total capacity 3C [standard + option]: 360 L | 95 US gal

[Total capacity 4C [standard + option]: 480 L | 127 US gal

[Not compatible with additional grey water tanks option]

LOCATION ON BOARD

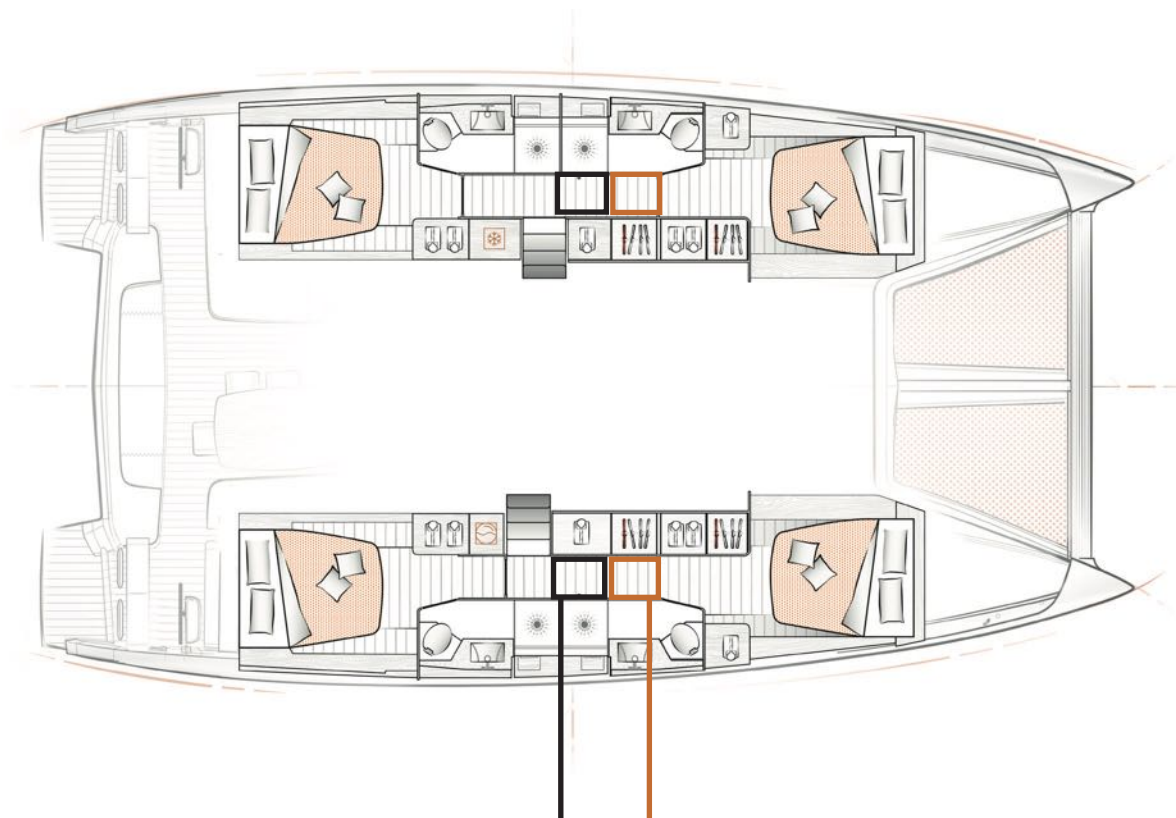

Standard: black water tank
2 x 120 L [2 x 32 US Gal]

Option: Additional black water tanks
2 x 120 L [2 x 32 US Gal]

ADDITIONAL BLACK WATER TANKS 3 OR 4 X 120 L

Standard

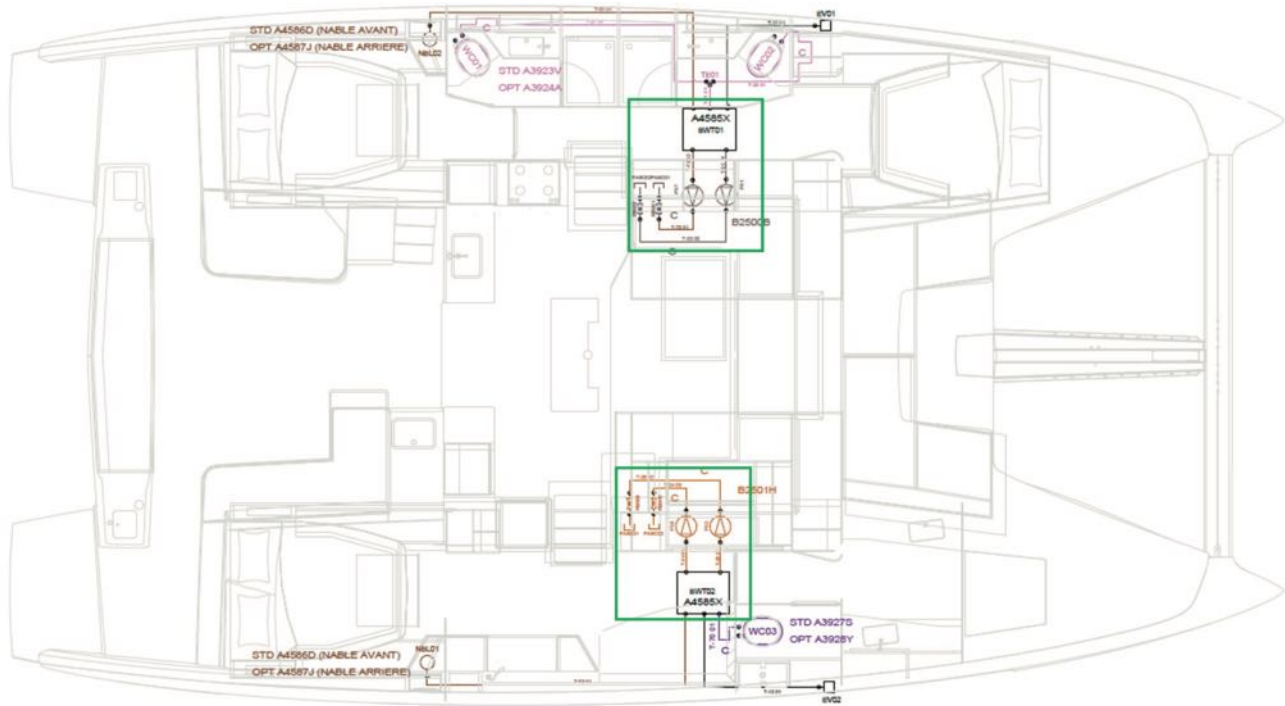

Option

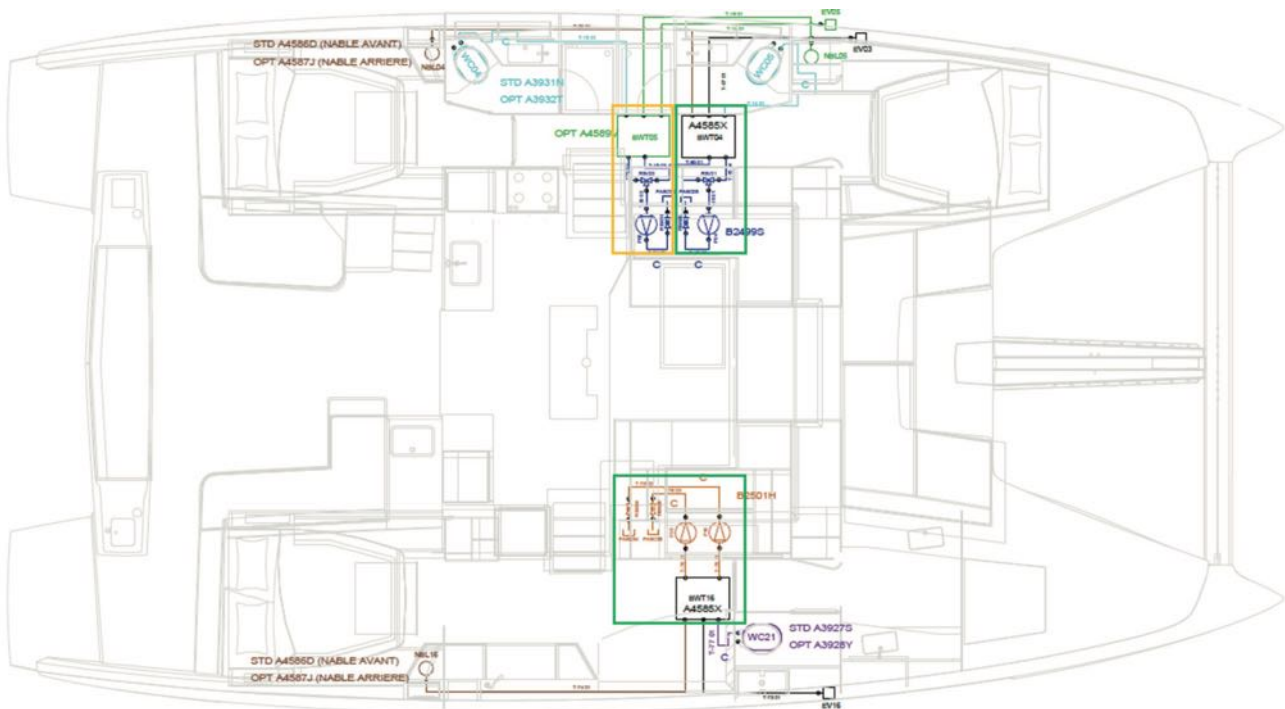

SEA WATER PUMP

04 TECHNICAL EQUIPMENT WATER CIRCUIT



DEDICATED TAP



Brand: NOBILI
Model: LV00236R



SWITCH
Flow time : 15 sec

Electric sea water pump is available, with an **additional** dedicated tap.
Pump located under floor in port companionway.



Electric pump 11L/min 12V

Brand: WHALE

LOCATION ON BOARD

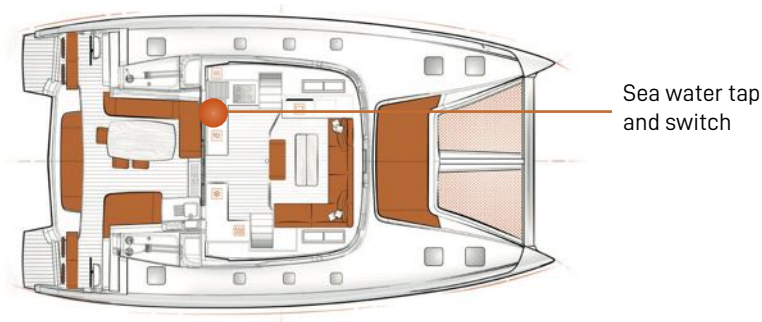

Sea water tap
and switch

FRESH WATER DOCK INLET

04 TECHNICAL EQUIPMENT WATER CIRCUIT



[Color upholstery no longer available]



Located on starboard transom, fresh water pump is connected to starboard fresh water standard tank.

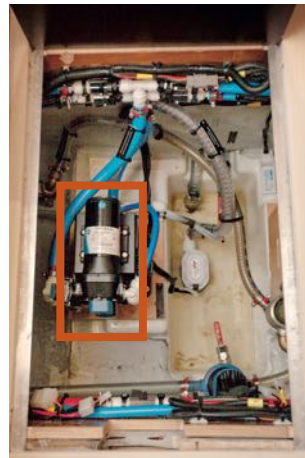

ON/OFF switch on fresh water pump located in starboard companionway.

LOCATION ON BOARD

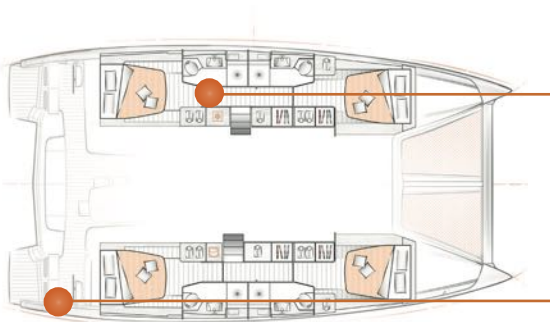

Switch on fresh water pump under floor in companionway

Fresh water dock inlet on starboard transom

DECK WASH PUMP [SEA WATER/FRESH WATER]



Outlet located on port forward deck.

Pump accessible from starboard companionway.

A manual valve, located in the starboard forward deck locker, allows the selection between sea water and fresh water.



LOCATION ON BOARD

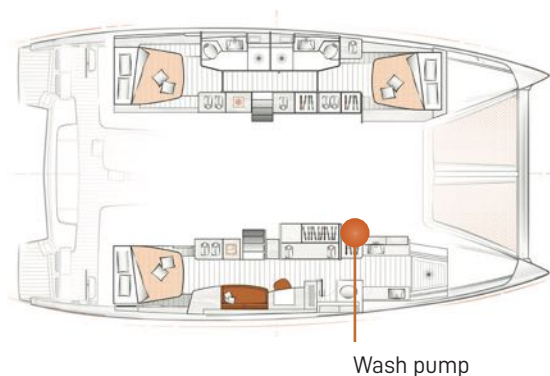
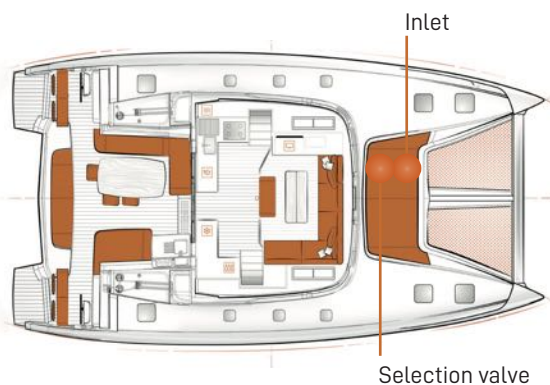

FRESH WATER ELECTRICAL TOILETS



This option is available for **3C, 4C and 6C versions**.
Replaces all the standard manual toilets.



Fresh water toilets

Brand: JABSCO

Model: Quiet Flush Electric Toilets 37045 Series

05

INSIDE EXPERIENCE

Extra for Honey Teak & White lacquered wood

Extra for Valley floor

Pack 1: Fast & Curious

Pack 2: Word Hard Play Hard

Pack 3: Less is More

PVC interior upholstery

Extra settee in the salon

Additional stool

Carpet in the salon

1Carpet in owner's cabin

Curtains on salon door and windows

INTERIOR EQUIPMENT

Additional middle cabins [Port and starbord]

Berth in bow compartments [Port and starboard]

Head in starboard bow compartment

Extra for adjustable wooden table in salon

Fans in salon and cabins

Freezer in salon 90 L

Bar & wine cooler in salon

Microwave oven and grill

Dishwasher 6 sets

Washer/dryer in starboard companionway

Additional fridge 130L in port companionway

Additional freezer 90L in port companionway

Extra for comfort mattresses

Air conditioning reverse cycle cruisair

HI-FI

TV antenna

Preffiting - TV in owner's cabin

Preffiting - TV in salon

FUSION sound pack in salon and cockpit

EXCESS Hi-fi pack by BOSE®

BOSE® Soundlike revolve bluethooth speaker

EXTRA FOR HONEY TEAK & WHITE LACQUERED WOOD

05 INSIDE EXPERIENCE



[White lacquered wood | Option]
with Fast & Curious upholstery



[Honey teak | Standard]
with standard upholstery

EXTRA FOR HONEY TEAK & WHITE LACQUERED WOOD

Standard wood



Honey teak

Wood upgrade

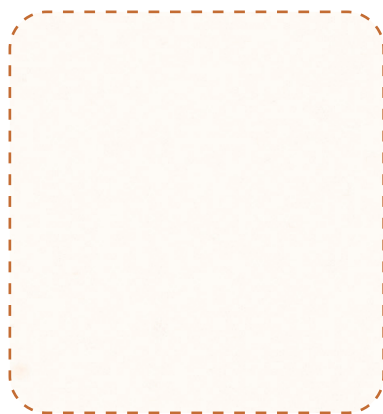

White lacquered wood

Floor



Sand

This option upgrades the existing standard finish [honey teak].

EXTRA FOR VALLEY FLOOR

05 INSIDE EXPERIENCE



[Valley floor | Option]
with Fast & Curious upholstery

Floor upgrade



Valley

This option replaces the existing standard finish [Sand floor].



Inside:

- EXTRA FOR FABRIC AND MANUFACTURING FINISHING INTERIOR UPHOLSTERY: Salon and Owner's cabin [NIMBUS - Sunbrella® SAV J350]
- DECORATIVE CUSHIONS KIT [See dedicated page]
- LEATHERETTE STORAGE | FOLDER ON BULKHEAD IN LIEU OF STANDARD [French Roast]
- FABRIC AND LEATHERETTE HANGING STORAGES IN LIEU OF STANDARD FABRIC IN CABINS [Leatherette : French Roast | Fabric : TIGERLILY - Sunbrella® 10222]
- FABRIC HEADBOARD [TANGERINE - Sunbrella® LOP R041]
- INTERIOR INDIRECT LIGHTING

Sofa

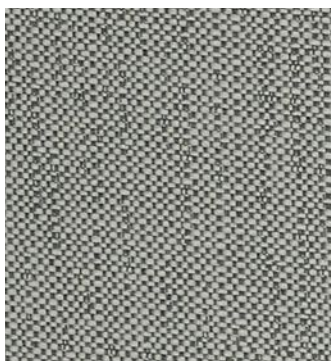

Nimbus

Storage | Folder on bulkhead

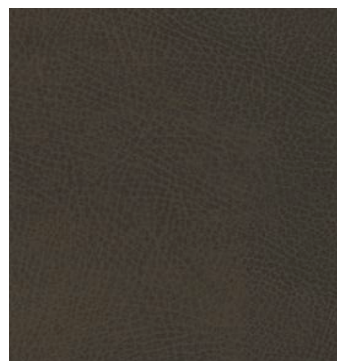

French Roast

Hanging storage



French Roast - Tigerlily

Headboard

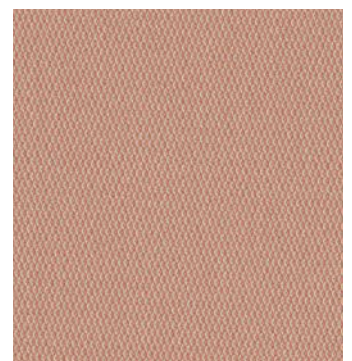

Tangerine

Decorative cushions

x2

SOOTY

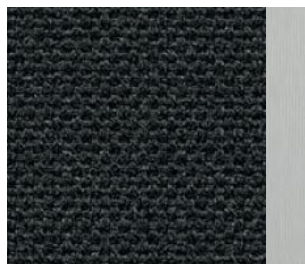

NATTE SOOTY NAT 10030
MARBLE SJA 3966 [Piping]

45x45 cm | 1'5"x1'5"

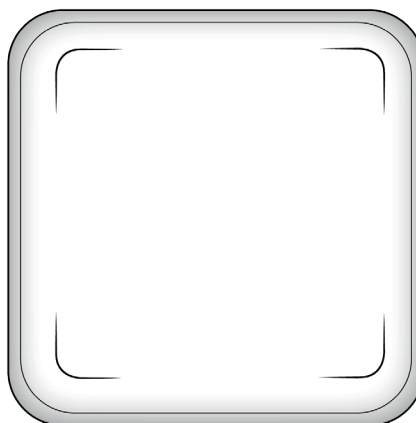

x1

SNOW

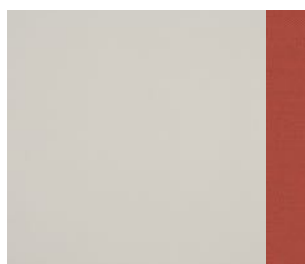

LOPI SNOW LOP R033
PAPRIKA SJA 3939 [Piping]

45x45 cm | 1'5"x1'5"

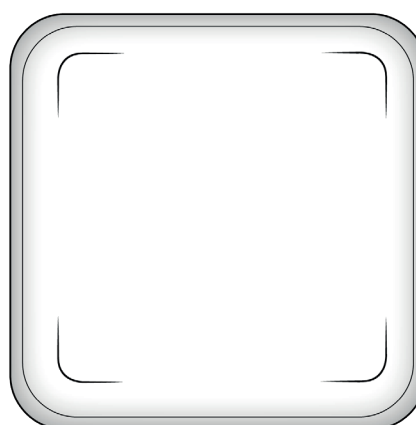

x1

PAPRIKA



PAPRIKA SJA 3939

47x28 cm | 1'6"x 0'11"

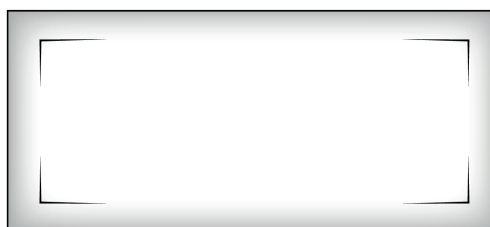



Inside:

- EXTRA FOR FABRIC AND MANUFACTURING FINISHING INTERIOR UPHOLSTERY: Salon and Owner's cabin [SLATE - Sunbrella® ARC R056]
- DECORATIVE CUSHIONS KIT [See dedicated page]
- LEATHERETTE STORAGES IN LIEU OF STANDARD [French Roast]
- FABRIC AND LEATHERETTE HANGING STORAGES IN LIEU OF STANDARD IN CABINS [Leatherette : French Roast | Fabric : HERITAGE INDIGO - Sunbrella® 18017 00]
- FABRIC HEADBOARD [LOTO - Sunbrella® DOM R044]
- INTERIOR INDIRECT LIGHTING

Sofa



Slate

Storage | Folder on bulkhead



French Roast

Hanging storage



French Roast - Indigo

Headboard

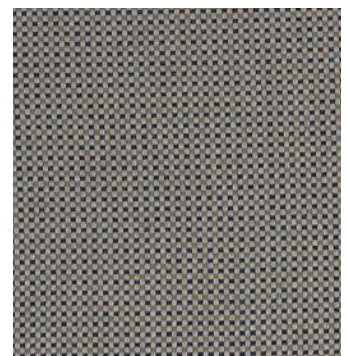

Loto

PACK 2: WORK HARD PLAY HARD

05

INSIDE EXPERIENCE

Decorative cushions

x2

INDIGO

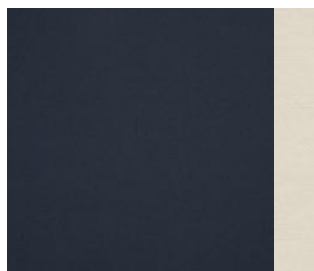

HERITAGE INDIGO - 18017 00
NATURAL SJA 5404 [Piping]

45x45 cm | 1'5"x1'5"

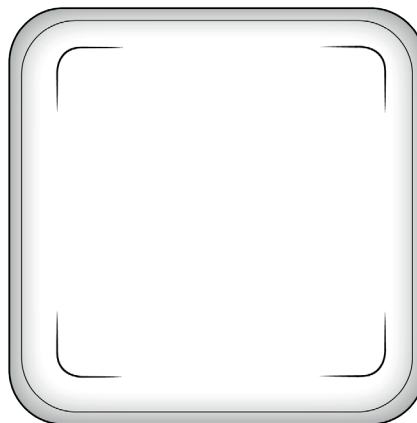

x1

BLUE STORM

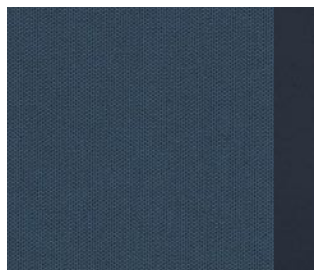

BLUE STORM SJA 3942
HERITAGE INDIGO - 18017 00 [Piping]

45x45 cm | 1'5"x1'5"

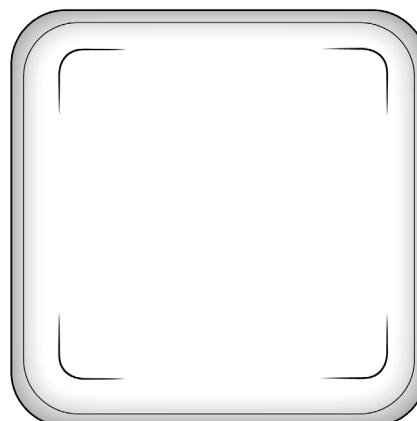

x1

LEAD CHINE

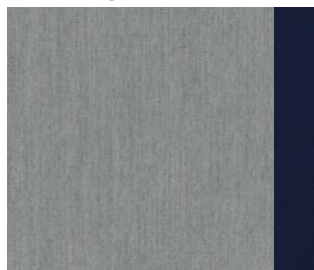

LEAD CHINE SJA 3756
RIVIERA BLUE SJA 3717 [Piping]

47x28 cm | 1'6"x0'11"

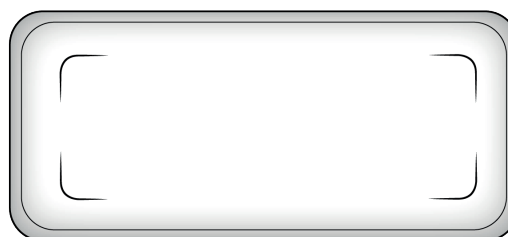



Inside:

- EXTRA FOR FABRIC AND MANUFACTURING FINISHING INTERIOR UPHOLSTERY: Salon and Owner's cabin [IPE - Sunbrella® ARC R054]
- DECORATIVE CUSHIONS KIT [See dedicated page]
- LEATHERETTE STORAGE IN LIEU OF STANDARD [French Roast]
- FABRIC AND LEATHERETTE HANGING STORAGE IN LIEU OF STANDARD IN CABINS [Leatherette : French Roast | Fabric : HERITAGE SLATE 18015 00]
- FABRIC HEADBOARD [ROULETTE - Sunbrella® DOM R047]
- INTERIOR INDIRECT LIGHTING

Sofa



Ipe

Storage | Folder on bulkhead



French Roast

Hanging storage



French Roast - Her. Slate

Headboard

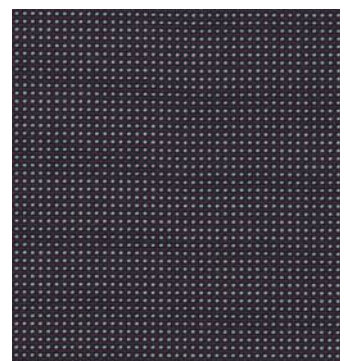

Roulette

Decorative cushions

x2

HENNA

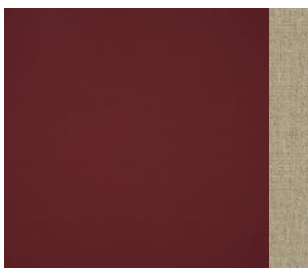

MEZZO HENNA 10223
HERITAGE ASH - 18001 00 [Piping]

45x45 cm | 1'5"x1'5"

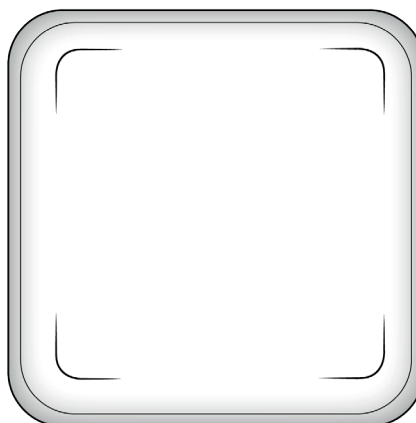

x1

ASH



HERITAGE ASH - 18001 00

45x45 cm | 1'5"x1'5"

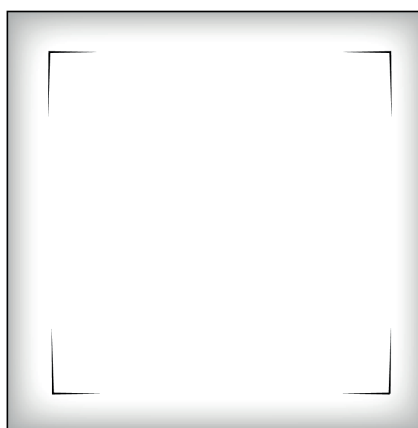

x1

CHALK

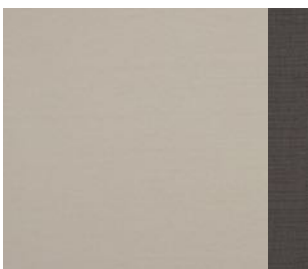

NATTE LINEN CHALK NAT 10151
DARK SMOKE SJA 33792 [Piping]

47x28 cm | 1'6"x 0'11"

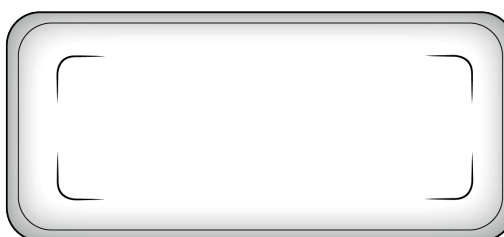

PVC INTERIOR UPHOLSTERY

Interior upholstery in white PVC, in salon sofa and settees.
Includes all settees in the salon and in the owner's cabin plus stool [3-cabin version]

Fabric changes: PVC upholstery
Same foam shape and manufacturing finishing as per standard.



Color: Snow white
Spradling® NUA-2450 / 11-0104 TPX

EXTRA SETTEE IN THE SALON

05

INSIDE EXPERIENCE

UPHOLSTERIES

A - STANDARD FOAM AND MANUFACTURING FINISHING



Dimensions: 890 H x 435 W mm | 2'11" x 1'5"
Thickness: 130 mm | 0'5"

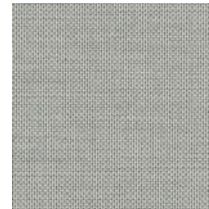

Color: Silver
Bru® Lounge Forte - 161 Silver



Color: Snow White
Spradling® NUA-2450 / 11-0104 TPX

B - **OPTIONAL** INSIDE TAILORED PACK

Foam as per standard. Leather upgrade finishing.

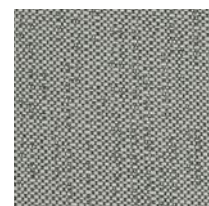

FAST AND CURIOUS
Color: Nimbus
Sunbrella® SAV J350



WORK HARD PLAY HARD
Color: Slate
Sunbrella® ARC R056

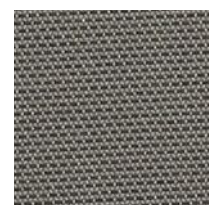

LESS IS MORE
Color: Ipe
Sunbrella® ARC R054

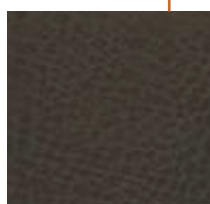

Leather strip upgrade finishing
Ultrafabrics® Ultra Leather
French Roast - 535-3231
[Same finishing for all tailored packs]

ADDITIONAL STOOL

05

INSIDE EXPERIENCE

UPHOLSTERIES

A - STANDARD FOAM AND MANUFACTURING FINISHING

Stool made in foam covered with fabric.
Dimensions: 423 H x 437 W mm | 1'4" H x 1'5" W

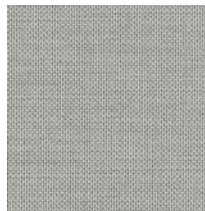

Color: Silver
Bru® Lounge Forte - 161 Silver



Color: Snow White
Spradling® NUA-2450 / 11-0104 TPX

B - OPTIONAL INSIDE TAILORED PACK



Foam as per standard. Leather upgrade finishing.

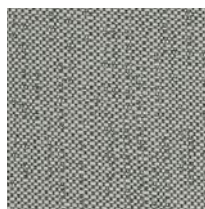

FAST AND CURIOUS
Color: Nimbus
Sunbrella® SAV J350



WORK HARD PLAY HARD
Color: Slate
Sunbrella® ARC R056



LESS IS MORE
Color: Ipe
Sunbrella® ARC R054

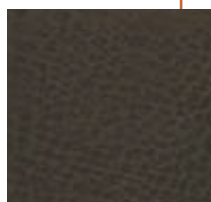

Leather strip upgrade finishing
Ultrafabrics® Ultra Leather
French Roast - 535-3231
[Same finishing for all tailored packs]

CARPETS IN SALON

05

INSIDE EXPERIENCE

UPHOLSTERIES



This option includes **1 carpet in salon.**

2 colors available: Grey [African Grey] or Beige [African Chalk]

Dimensions: 2,275 x 1,575 mm | 7'4" L x 5'2" W



African Grey



African Chalk

LOCATION ON BOARD

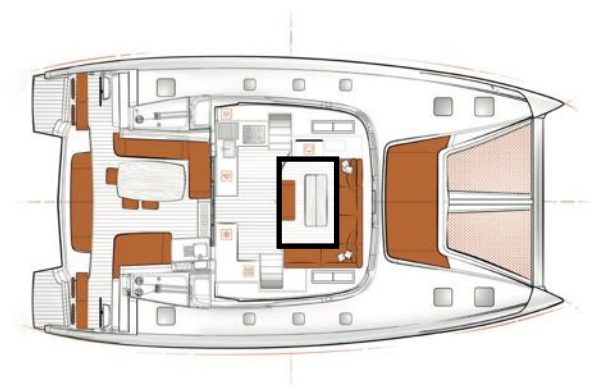

CARPETS IN OWNER'S CABIN



This option includes **1 carpet in Owner's suite** [3-cabin version].
2 colors available: Grey [African Grey] or Beige [African Chalk]
Dimensions: 3,400 x 810 mm | 11'1" L x 2'7" W



African Grey

African Chalk

LOCATION ON BOARD

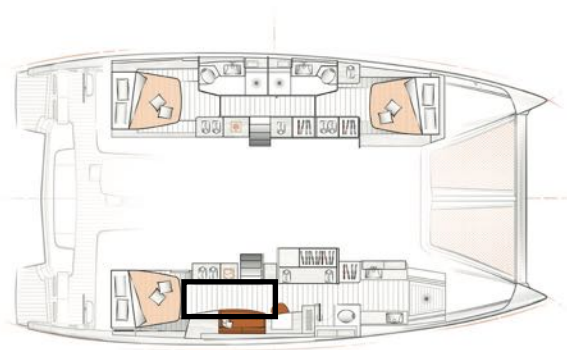

CURTAINS ON SALON DOOR AND WINDOWS

NEW: all salon curtains are in the same option.

The option includes:

- Curtains on aft door to cockpit
- Curtains on all roof windows in salon

ADDITIONAL MIDDLE CABINS [PORT AND STARBOARD]

05

INSIDE EXPERIENCE

INTERIOR EQUIPMENT

Additional mid cabin is available for 3 and 4 cabin version, on port or starboard.

The option comes with:

- A dedicated access to the forward head through a door in the companion way
- Additional windows on salon sides for ventilation and natural light

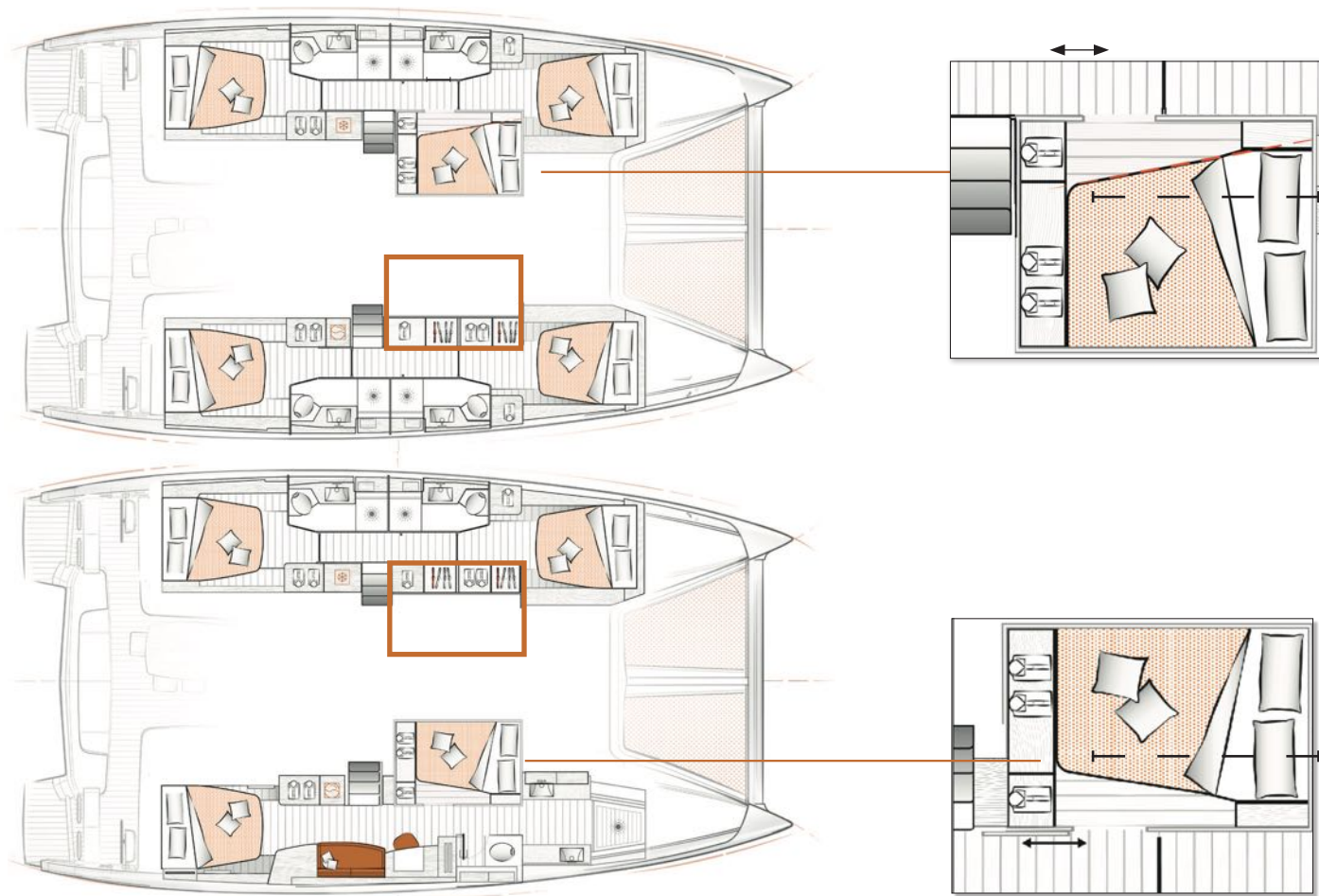

3 different bed positions : sofa, single bed, double bed



1- Single bed
1.05/0.80 x 2.00 m
3'5"/2'7" x 6'6"



2- Sofa
1.05/0.80 x 2.00 m
3'5"/2'7" x 6'6"



3- Double bed
1.30/1.05 x 2.00 m
4'3"/3'5" x 6'6"

BERTH IN BOW COMPARTMENTS [PORT AND STARBOARD]

05

INSIDE EXPERIENCE

INTERIOR EQUIPMENT

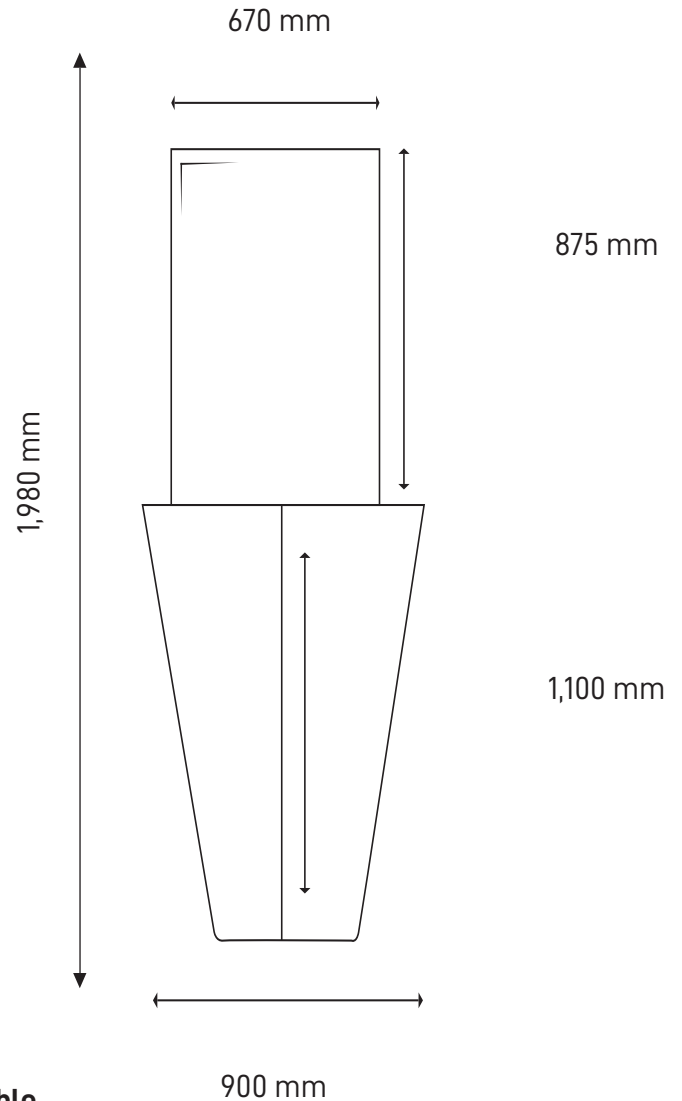

The option is available on **port and starboard**.

The option includes:

- Wooden storage with soft closing [white batyline]
- Mattresses

[Berth in starboard bow compartment: **not compatible** with head in starboard bow compartment]

LOCATION ON BOARD

Thickness: 120 mm

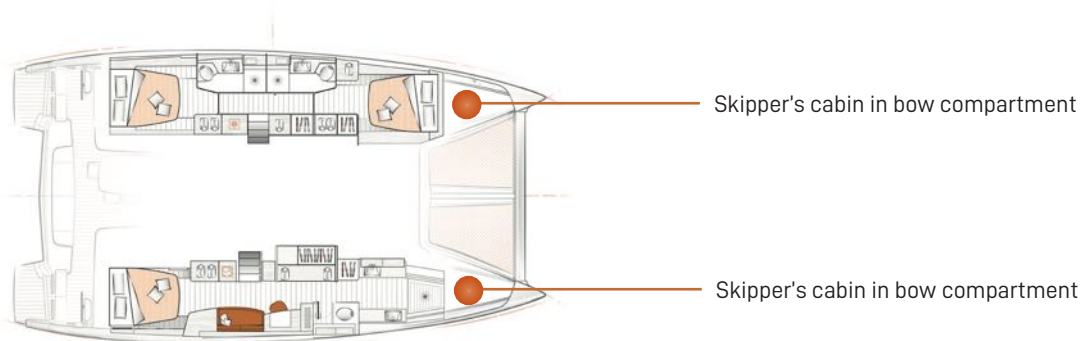

HEAD IN STARBOARD BOW COMPARTMENT



The option includes :

- Shower
- Sink
- Toilet
- Dedicated black water tank [120 L - 32 US Gal]
- Storages

[Not compatible with berth in starboard bow compartment]

LOCATION ON BOARD

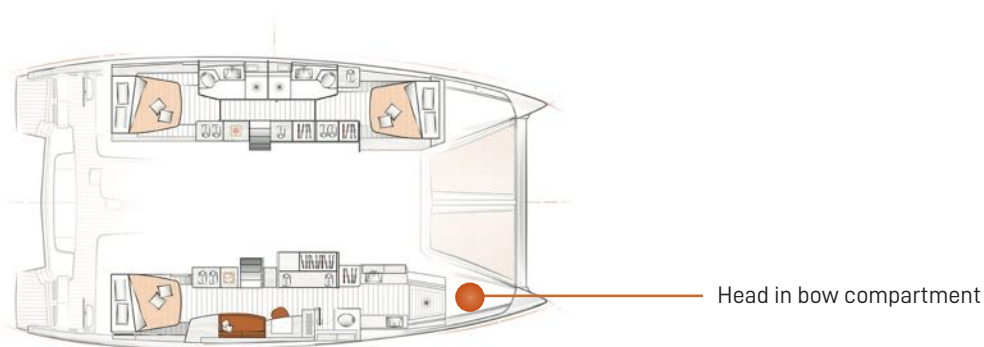

EXTRA FOR AJUSTABLE WOODEN TABLE IN SALON



In the salon, a convertible dining table into a coffee table thanks to **electrical stainless steel pedestal**.
[modular table]

The option includes :

- 1 electrical stainless steel table pedestal to low and raise the table
- 2 foldable parts on table top

Dimensions

Coffee table: [1,400 L x 600 W x 438 H mm | 4'7" x 1'11" x 1'5"]

Dining table: [1,400 L x 1,200 W x 744 H mm | 4'7" x 3'11" x 2'5"]

The option upgrades the standard table [1,400 x 1,125 mm | 4'7" x 3'8"].

FANS IN SALON AND CABINS

05

INSIDE EXPERIENCE

INTERIOR EQUIPMENT



Brand/Model: BORA
Color: White

- The option includes:
- 1 Fan per cabin
 - 2 Fans in Owner's suite
 - 2 Fans in salon

Please note, port and starboard middle cabins are equipped with fans per standard.

LOCATION ON BOARD

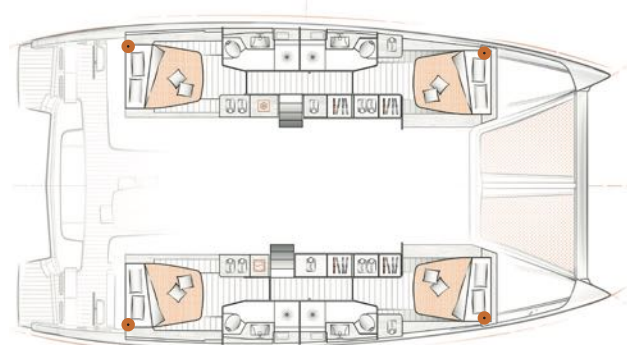
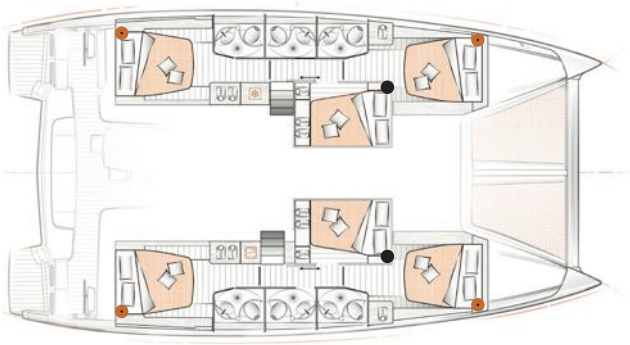
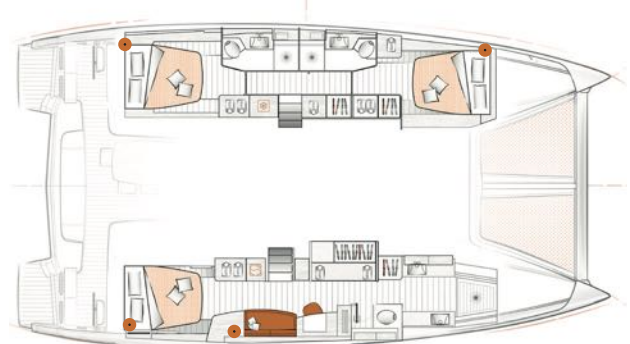
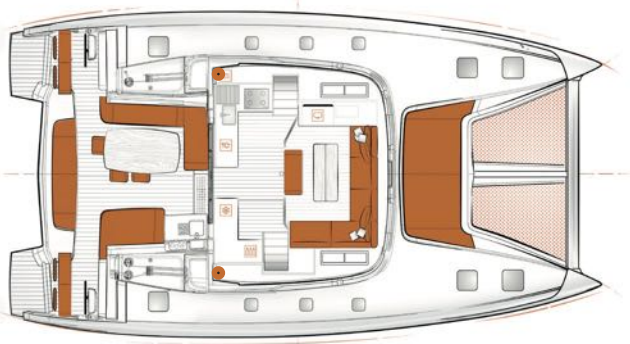

FREEZER IN SALON 90 L



Optional 12V freezer [90 L | 24 US gal] on starboard galley. Replaces the storage unit per standard. [Not compatible with bar and wine cooler option]



Brand: Webasto
Model: CRUISE 90 Freezer [Inox] Clean Touch

[Webasto - Freezer Cruise 90](#)

LOCATION ON BOARD

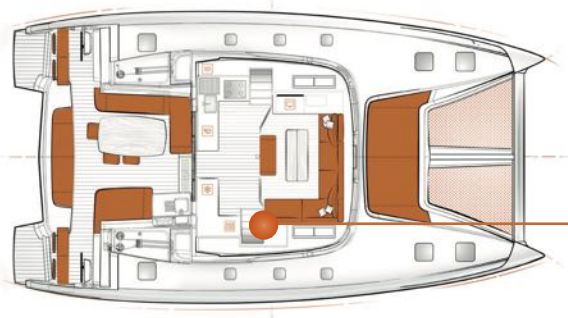

Freezer 90 L | 24 US gal

BAR AND WINE COOLER IN SALON

05

INSIDE EXPERIENCE

INTERIOR EQUIPMENT



Located in the salon on starboard.
Replaces the storage unit per standard.

[Not compatible with freezer option]

The option includes:

A - Wine cooler

Brand: DOMETIC

Model: Wine cooler - Dometic D15

Capacity: 17 bottles

Available in 230 V and 120 V

[Dometic - Wine Cooler](#)



B - Bar facilities

Sliding system with bottles storage and
additional drawers.

LOCATION ON BOARD

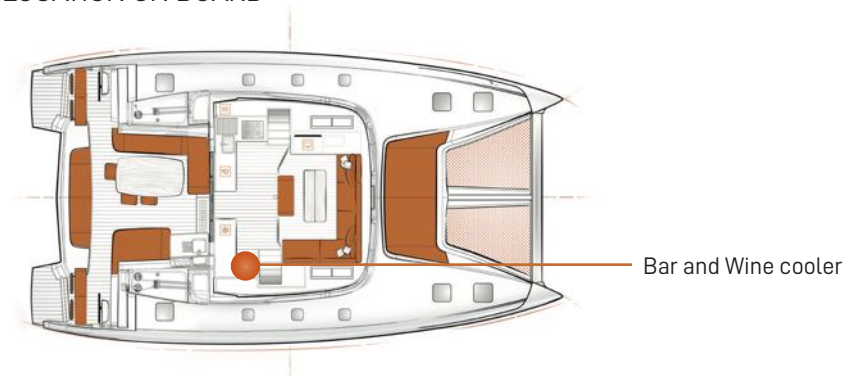

MICROWAVE OVEN GRILL

05

INSIDE EXPERIENCE

INTERIOR EQUIPMENT



Microwave with grill and oven functions is available on **230V 50Hz** and **prefitting only for 120V 60Hz version**.



Located on port galley.

Brand: PANASONIC
Model: NN-SD27HSUPG

[Panasonic - Microwave](#)

LOCATION ON BOARD

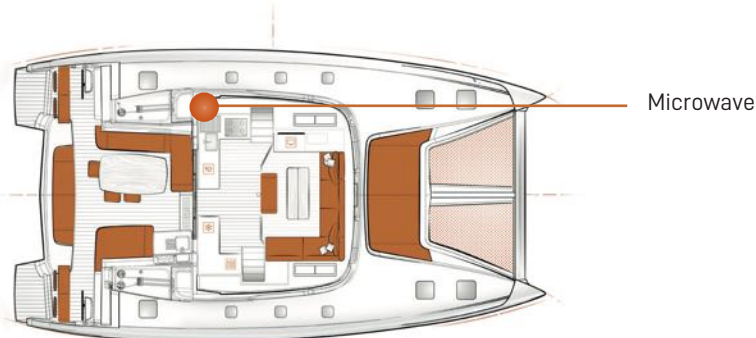

DISHWASHER 6 SETS

05

INSIDE EXPERIENCE

INTERIOR EQUIPMENT



The dishwasher is available on **230V 50Hz** and **prefitting only for 120V 60Hz version**.



The option replaces standard drawers.

Brand: ELECTROLUX

Model: ESL2500RO

Capacity: 6 sets

Dimensions: 550 L x 500 D x 438 H mm | 1'9" x 1'7" x 0'44"

[Electrolux - Dishwasher](#)

LOCATION ON BOARD

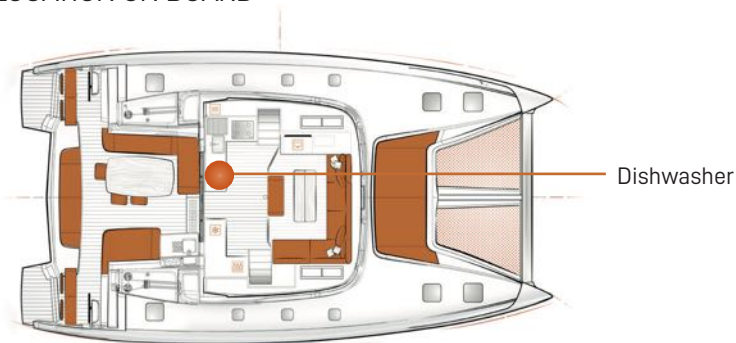

WASHER/DRYER IN PORT COMPANIONWAY

05 INSIDE EXPERIENCE

INTERIOR EQUIPMENT



[Option configuration in 3-cabin version]



[Standard configuration in 3-cabin version]

WASHER/DRYER IN PORT COMPANIONWAY

05

INSIDE EXPERIENCE

INTERIOR EQUIPMENT

230V 50Hz version



Capacity
 Washer: 7kg
 Dryer: 4kg

Brand: SIEMENS
 Model: WK14D541FF

[Siemens - Washer Dryer](#)

120V 60Hz version



Capacity
 Washer: 15 lbs
 Dryer: 11 lbs

Brand: SPLENDIDE
 Model: WDC7100XC

[Splendide - Washer Dryer](#)

LOCATION ON BOARD

3-cabin version

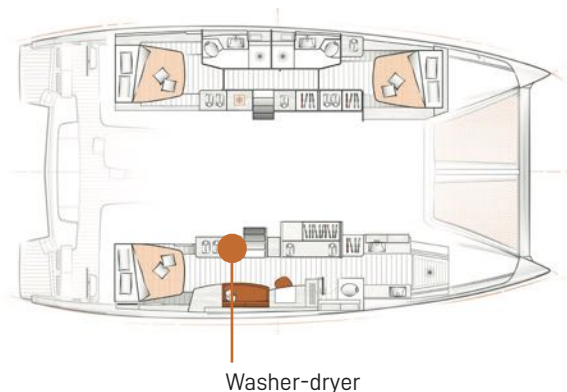

Washer-dryer

4-cabin version

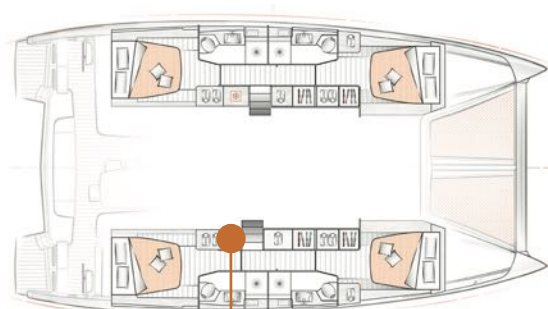

Washer-dryer

ADDITIONAL FRIDGE 130 L IN PORT COMPANIONWAY

05

INSIDE EXPERIENCE

INTERIOR EQUIPMENT



130 L | 34 US Gal [12 V]



Brand: WEBASTO

Model: CRUISE 130 INOX Clean Touch

Dimensions: 750 H x 545 L x 555 D mm |
2'5" x 1'9" x 1,9"

[Webasto - Fridge](#)

12 V Fridge located on port companion way.

[Reference no longer available]

LOCATION ON BOARD

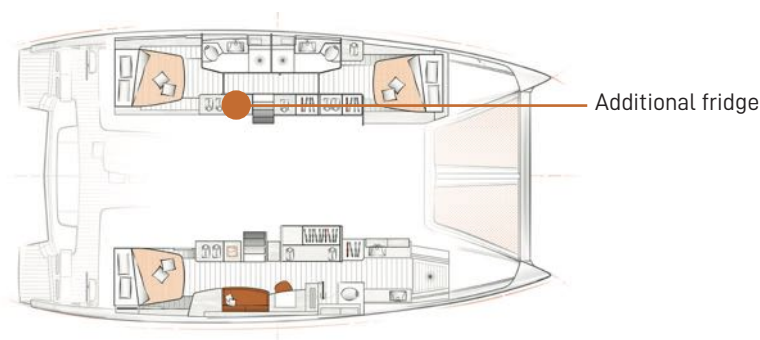

ADDITIONAL FREEZER 90L IN PORT COMPANIONWAY

05

INSIDE EXPERIENCE

INTERIOR EQUIPMENT



90 L | 24 US Gal [12 V]



Brand: WEBASTO
Model: CRUISE 90 INOX Clean Touch

Dimensions: 750 x 545 x 565 mm |
2'5" x 1'9" x 1'10"

[Webasto - Freezer](#)

12V Freezer located on port companion way.

[Reference no longer available]

LOCATION ON BOARD

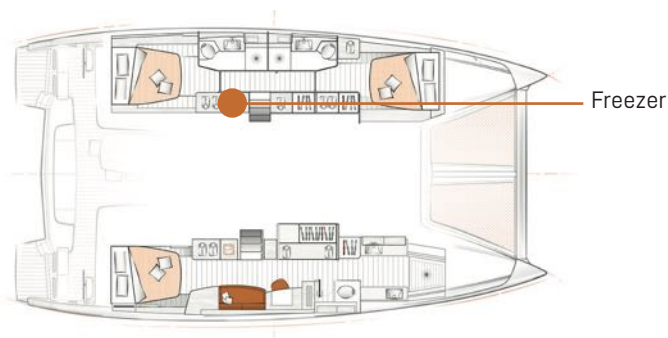

EXTRA FOR COMFORT MATTRESSES

AVAILABLE FOR 3 & 4 CABIN VERSIONS



The option upgrades mattresses in forward and aft cabin.

[Option]

Thickness: 150 mm | 0'5"

Composition:

-200 g/m² Wadding

-HR Foam [density 40 kg | 88 lbs]

-Pocketed coils [innersprings]

[Standard]

Thickness: 120 mm | 0,4"

Composition:

HR Foam [density 35 kg | 77 lbs]

AIR CONDITIONING REVERSE CYCLE CRUISAIR

05

INSIDE EXPERIENCE

INTERIOR EQUIPMENT

AVAILABLE FOR 3, 4 & 6-CABIN VERSIONS [230 V | 120 V]

[ONAN genset option mandatory]

Seawater-cooled AC unit: Heat is transferred from the cabin air to the refrigerant gas to the seawater.
Reverse cycle on heating mode

Total BTU :

3 & 4-Cabin version: 64 000 BTU

6 Cabin version: 71 000 BTU

1 x control device per cabin

2 x control devices in the salon [located on starboard]

Blowing grids



Additional AC shore power



Control device



Control device



AIR CONDITIONING REVERSE CYCLE CRUISAIR

05

INSIDE EXPERIENCE

INTERIOR EQUIPMENT

AVAILABLE FOR 3, 4 & 6-CABIN VERSIONS [230V | 120V]

LOCATION ON BOARD

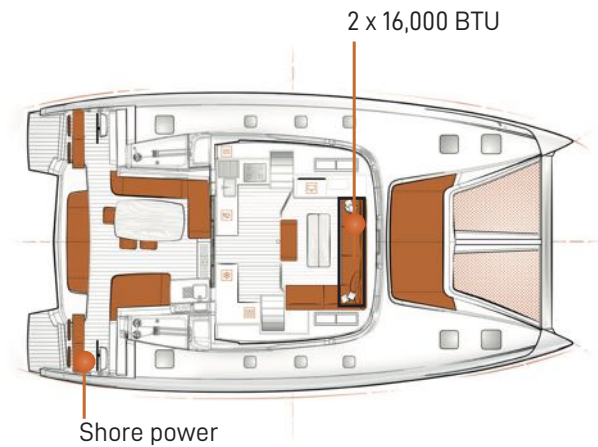

[salon]

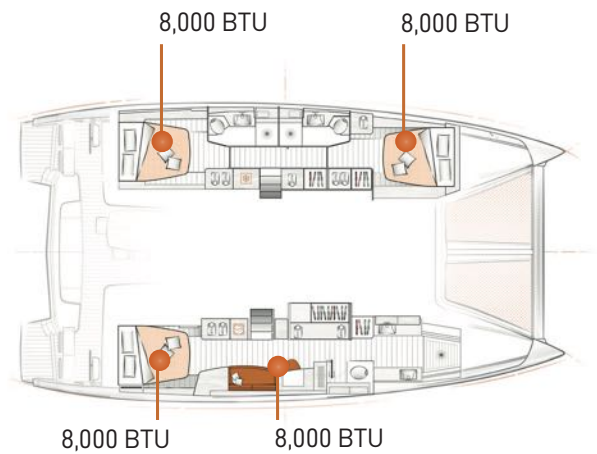

[3C version]

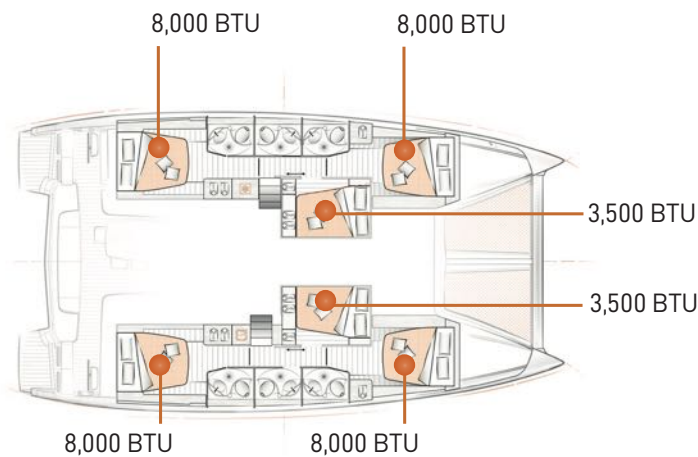

[4C2T version]

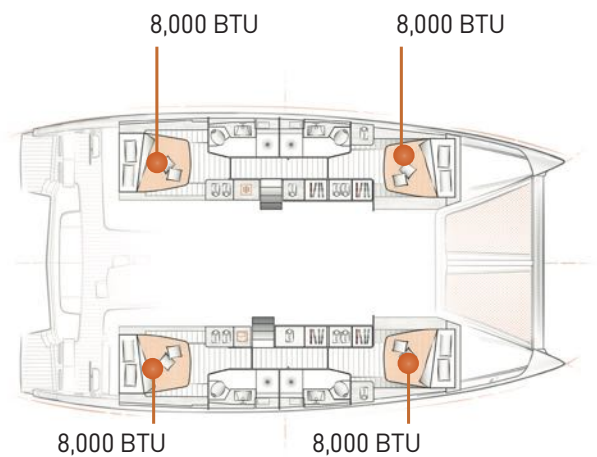

[4C4T version]

Electrical specification:

230V version: additional 1 x 32 A shore power included in the option

120V version:

- SAIL AWAY shore power is replaced by a 50A shore power
- An additional 50A shore power is added on board

[To use the air conditioning: to connect on the shore power or to the generator]

AIR CONDITIONING REVERSE CYCLE CRUISAIR MID CABIN

[230 V | 120 V]

Air conditioning reverse circle CRUISAIR in middle cabin.

[Available for PORT & STARBOARD mid cabins]

[ONAN genset option mandatory]

Total BTU :

Mid-cabin: 3,500 BTU per cabin

1 x control device on bed head

LOCATION ON BOARD

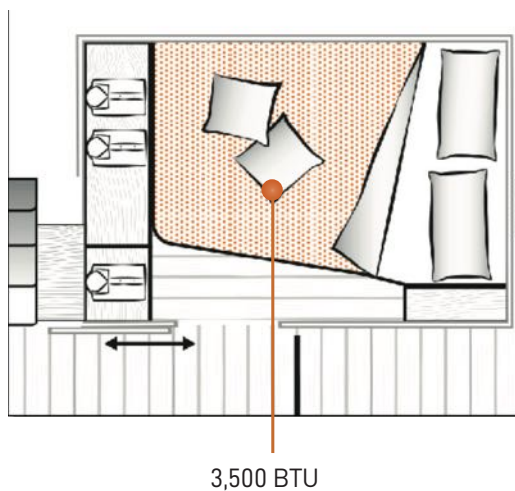

Please note, port and starboard middle cabins are equipped with fans per standard.

TV ANTENNA

05

INSIDE EXPERIENCE

HI-FI

The option includes :

- TV antenna
- TV antenna amplifier
- TV cable pre-installed in roof to link amplifier and antenna

PREFITTING FOR TV IN OWNER'S CABIN

05

INSIDE EXPERIENCE

HI-FI

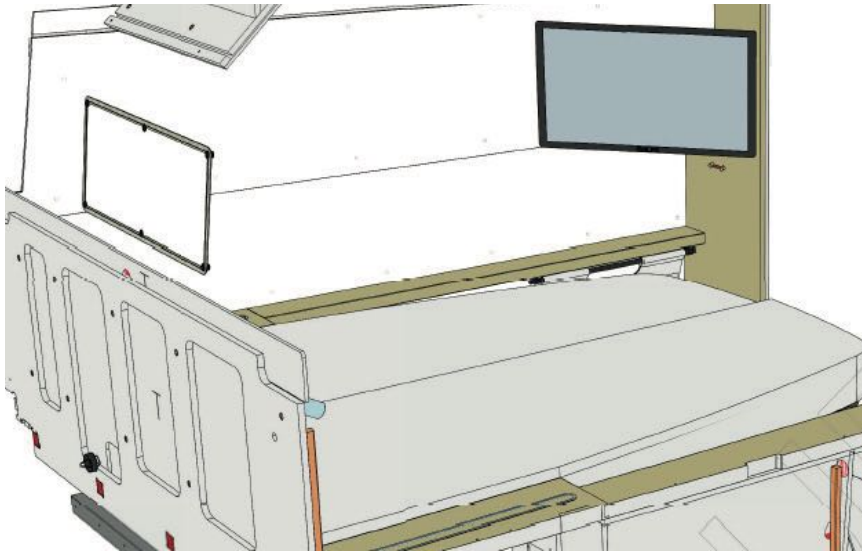

NEW A2022: Prefitting option only.

Available for 120 and 230V. Mounted on the wall, facing the Owner's bed.
Starting from 15#09

TV not included.

Available in 3-cabin version only.

PREFITTING FOR TV IN THE SALON

05

INSIDE EXPERIENCE

HI-FI



NEW A2022: Prefitting option only.
Available for 120 and 230V.
Starting from 15#09

TV not included.

FUSION SOUND PACK IN SALON AND COCKPIT

NEW: FUSION sound pack

- FUSION stereo unit [Apollo MS-RA670]
- USB socket x1
- Loudspeakers x2 in the salon [FM-F65RW]
- Loudspeakers x2 in the aft cockpit [FM-F65RW]



Stereo unit [Located in the chart table]

Brand: FUSION
Model: Apollo MS-RA670
Color: Black



Loudspeaker

Brand: FUSION
Model: FM-F65RW
Color: White

Sources:

RADIO / WiFi / Bluetooth / AUX

Control:

From the front panel

From the navigation screens

From the FUSION app

Same audio source and volume in the salon and outside.

EXCESS HIFI PACK BY BOSE

05

INSIDE EXPERIENCE

HI-FI



The option includes :

- Soundlink revolve bluetooth speaker [BOSE®]
- Charging Cradle [BOSE®]
- Excess storage box

Speaker

- 360° uniform coverage
- IPX4 Splashproof
- 12 Hours of autonomy
- Bluetooth wireless pairing with voice prompts
- Take calls and access Siri or Google Now directly Pair two speakers together
- Multi-connect to two devices
- BOSE® Connect app
- NFC pairing
- Charges via micro-USB Type-B port
- Auxiliary input
- Dimensions: 15,2 x 8,2 cm | 0'5" x 0'3"
- Color: Grey or black



Charging cradle

- The speaker will work even during charging
- USB Port for plugging the cradle
- Color: Black

High-quality and brand customization, this Pack offers a fully movable Hi-Fi solution onboard.



BOSE SOUNDLINK REVOLVE BLUETOOTH SPEAKER

05

INSIDE EXPERIENCE

HI-FI



The BOSE® speaker is available single.

Speaker

- 360° uniform coverage
- IPX4 Splashproof
- 12 Hours of autonomy
- Bluetooth wireless pairing with voice prompts
- Take calls and access Siri or Google Now directly

Pair two speakers together

- Multi-connect to two devices
- BOSE® Connect app
- NFC pairing
- Charges via micro-USB Type-B port
- Auxiliary input
- Dimensions: 15,2 x 8,2 cm | 0'5" x 0'3"
- Color: Grey or black



06

ACCESSORIES

Dinghy set CL340 with Yamaha engine 20HP

Windsup

Safety kit 8 PAX

Liferaft 8 PAX

EXCESS tool box

EXCESS mooring kit

DINGHY PACK CL340 WITH YAMAHA ENGINE 20HP

06 ACCESSORIES



Brand: Highfield
Model: CL340
Console
Grey synthetic teak

Overall Length: 3,40 m | 11'1"
Overall Width: 1,73 m | 5'8"
Weight empty boat: 70 kg | 154 lbs
Maximum charge: 620 kg | 1,367 lbs
Engine
BF 20CV Yamaha [12 L | 3 US gal]

Delivered with:

- Waterproof storage bag
- Security Kit
- Reams
- Blower
- Tibular console
- Portable fuel tank [12 L | 3 US gal]

HIGHFIELD
aluminium boats



The Windsup is a windsurfing board that you can paddle, delivering authentic windsurfing with inflatable versatility. This is a board with all the practical benefits of an inflatable SUP that's also designed specifically with beginner windsurfers in mind, but can make a great coastal cruiser for more experienced riders.



Brand : RED Paddle Cow

Dimensions :

Length : 10'7 [3.26m]

Width : 33" [838mm]

Thickness : 4.7" [120mm]

Volume : 257 L

Rider weight: until 120Kg

Sail area : 4.5 m²

Mast height : 4m [provided in 2 parts]

Includes :



BAG



PUMP



FINS



PADDLES



RIGS



ACCESSORIES

INFLATABLE PADDLE BOARD



FINS



RIGS

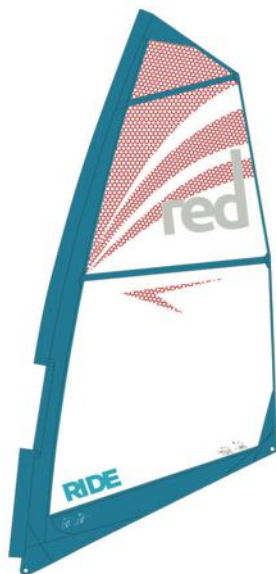

ACCESSORIES



PUMP

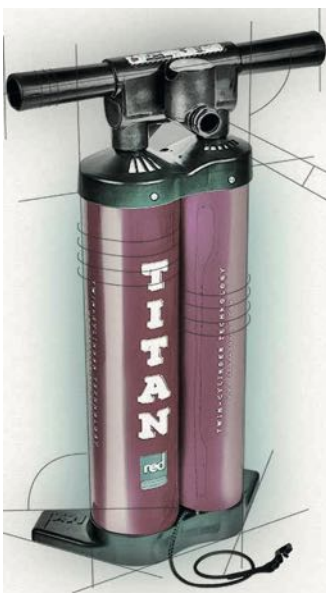

PADDLES



BAG



SAFETY KIT 8 PAX

06

ACCESSORIES



- 1 x Horse shoe buoy cover
- 1 x Buoy and floating light
- 1 x Floating line Ø8mm (30m)
- 1 x Shroud shears 90cm (maximum 16mm diameter)
- 8 x 165N lifejacket with crotch and strap
- 8 x Flashing light
- 8 x Harness tether
- 1 x Flare kit (6 x Hand flare - 4 x Parachute flare - 2 x Floating smoke)
- 1 x Set of 2 Wichard adjustable jackstays
- 1 x Set of 9 wooden bungs size S
- 1 x Set of 9 wooden bungs size L
- 1 x 10L bucket with 1.5m floating line
- 1 x Set of 3 emergency navigation lights
- 3 x LR20 batteries
- 1 x Flag N 30x40cm
- 1 x Flag C 30x40cm
- 1 x Flag Q 30x40cm
- 1 x Waterproof flash light (4 LED)
- 1 x Search light
- 1 x Lead line (30m with marke every meter)
- 1 x Bailer
- 1 x ABC 6kg extinguisher (powder)
- 4 x ABC 1kg extinguisher (powder)
- 1 x Fire blanket
- 1 x TRUMP foghorn
- 1 x Black cone

LIFERAFT 8 PAX

06 ACCESSORIES



Brand: Seasafe

Size: 8 persons

Model: 8 pax [24h+] ISO 9650-1 SOLAS pack B

The option includes :

- 1 Liferaft 8 pax [24h+] ISO 9650-1 SOLAS pack B - Seasafe
- 1 Baller
- 2 Sponges
- 2 Paddles
- 1 First Aid kit
- 1 Whistle
- 1 Waterproof torch with spare batteries and bulb
- 1 Daylight signal mirror
- 1 Radar Reflector
- 6/pers Anti sea sickness pills
- 1/pers Sea sickness bag
- 3 Hand flares
- 2 Parachute rockets
- 1 Smoke signal
- 2 Survival blankets
- 1 Repair outfit
- 1 Inflating pump
- 1 Fishing kit
- 1 Rescue quoit and line [30 m | 98'5"]
- 1 Floating knife
- 1 Sea anchor and cord [30 m | 98'5"]



The Facom toolbox includes:

- 1 PVC coated fabric softbag [50 cm]
- 12 Metric offset combination wrench
- 1 Chromed sheath adjustable wrench
- 9 Allen wrench keys - sperical head
- 1 Set of sockets - metric [23 pieces]
- 7 Stainless steel screwdrivers
- 1 Multigrip pliers [25 cm]
- 1 Combination pliers [18 cm]
- 1 Adaptable-tip sledgehammer [40 mm]
- 1 Hacksaw frame
- 1 Caliper
- 1 Tape measure
- 1 Cutter with 9mm snap-off blades
- 1 Riveting engineers hammers [26 mm]
- 1 Masking tape
- 100 White nylon cable ties 6.6
- 1 Lubricant spray WD 40
- 1 Adjustable oil-filter wrench
- 1 PTFE Roll [12 m]
- 1 Half-round file [200 mm]
- 1 Double sided tape [25 m]
- 1 Prism 401 glue [3 g tube]
- 1 Voltage tester
- 1 Electrical tape - black [10 m]

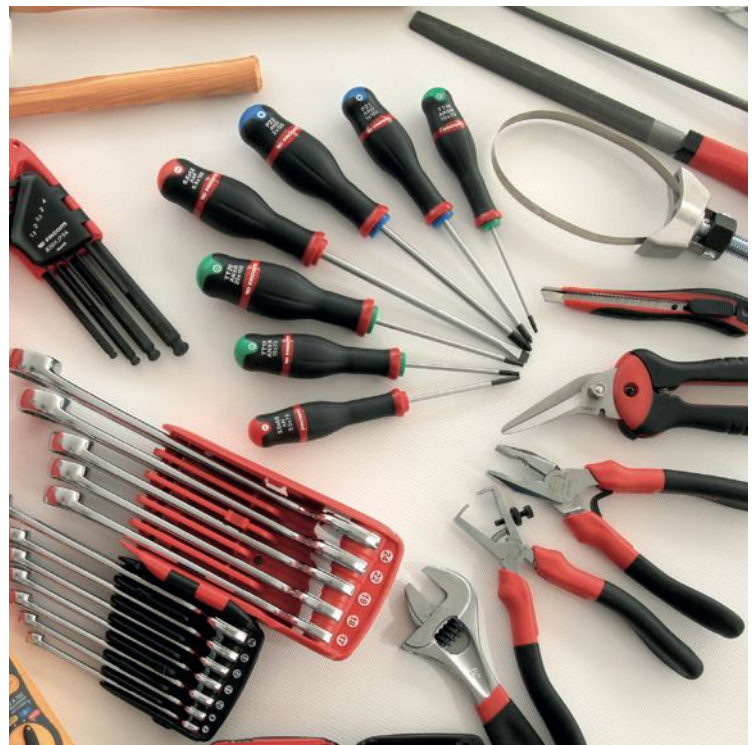

EXCESS MOORING KIT

06 ACCESSORIES



The option includes:

- 4 Dock lines
- 6 Cylindrical inflatable fenders [with covers and bag]
- 12V Blower



CNB
162, quai de brazza CS 81217
33072 Bordeaux Cedex France

EXCESS-CATAMARANS.COM