



VIA

USER MANUAL

V8.0

VIA

© 2023 SIMARINE

All rights reserved. No parts of this work may be reproduced in any form or by any means - graphic, electronic, or mechanical, including photocopying, recording, taping, or information storage and retrieval systems - without the written permission of the publisher.

Products that are referred to in this document may be either trademarks and/or registered trademarks of the respective owners. The publisher and the author make no claim to these trademarks.

While every precaution has been taken in the preparation of this document, the publisher and the author assume no responsibility for errors or omissions, or for damages resulting from the use of information contained in this document or from the use of programs and source code that may accompany it. In no event shall the publisher and the author be liable for any loss of profit or any other commercial damage caused or alleged to have been caused directly or indirectly by this document.

1. Introduction	7
1.1 About	8
1.2 Schematics	9
2. Accessories	11
3. Safety	13
4. Declaration of conformity	15
5. Installation	17
6. Basic Setup	19
6.1 VIA buttons	21
6.2 Settings Screen	23
6.3 Start screen after first connection	24
6.4 Battery configuration	25
6.4.1 Adding a new battery	25
6.4.2 Advanced settings	27
6.5 Tank configuration	29
6.5.1 Adding a new tank	29
6.6 Temperature sensor configuration	31
6.6.1 Add a new temperature sensor	31

6.7	Inclinometer configuration	32
6.7.1	Adding a new inclinometer	32
6.8	User sensor configuration	33
6.8.1	Adding a user sensor	33
6.9	Current sensor configuration	34
6.9.1	Adding a current sensor	34
7.	Device configuration	37
7.1	General settings	38
7.1.1	Screen	38
7.1.2	Device	39
7.1.3	Language	39
7.1.4	Units	39
7.2	Data management	40
7.2.1	Alarm screen	41
7.3	Devices	42
7.3.1	Batteries	42
7.3.2	Tanks	43
7.3.3	Temperature sensors	44
7.3.4	Current sensors	45
7.3.5	Voltmeters	45
7.3.6	Ohmmeters	46
7.3.7	Coulomb counter	46



7.3.8	Inclinometers	46
7.3.9	User Sensors	47
7.3.10	Control unit	47
7.3.11	Power unit	47
7.4	WI-FI	48
7.4.1	AP Mode	48
7.4.2	STA Mode	48
7.5	Date & Time	50
7.6	Service	51
7.7	System	52
8.	Panel and Power Unit configuration	53
8.1	Configuring a button to display a specific screen	57
8.2	Configuring a button to toggle a different relay	57
9.	Mobile App	59
10.	Save and restore settings	61
11.	Firmware upgrade	63
12.	Technical specifications	65



1. Introduction

Congratulations on your purchase of the VIA, formerly known as Caravan Control Panel.

VIA is a device used to control appliances and monitor DC power sources such as batteries, inclinometers, tanks, and solar panels of your caravan.

The information is displayed on a large 3,5" high resolution IPS display with Gorilla® Glass and anti-reflective coating to ensure superior visibility. It comes with 8 control buttons prepared for the convenience of the user.

VIA is capable of monitoring up to 6 batteries, 14 tanks, 14 temperatures, and 20 independent current sensors (shunts) as well as controlling 2 relay switches. It is equipped with a Wi-Fi module to communicate with the application available for Android™ and iPhone® smartphones. The app allows accessing live data, analyzing saved data, configuring the panel, and performing a firmware upgrade of the system.

1.1 About

In this manual we will show you how to install the Caravan Control Panel and configure the settings. For information on how to setup the **SPDU-52**, please check the **SPDU-52** manual.

You can find more information on other shunts, modules installations, and devices on the website:
<https://simarine.net/manuals>

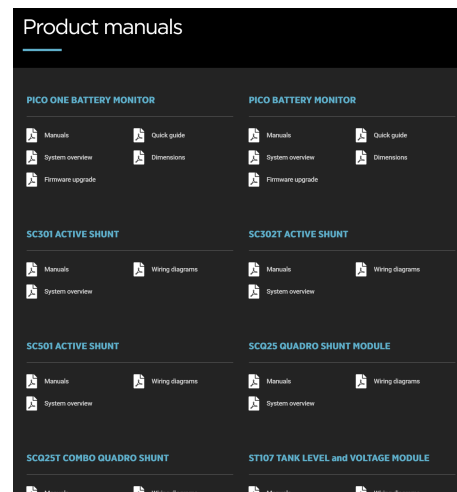

1.2 Schematics

All measurements are in millimeters (mm).

Required mounting space is at least 30 mm behind the casing.

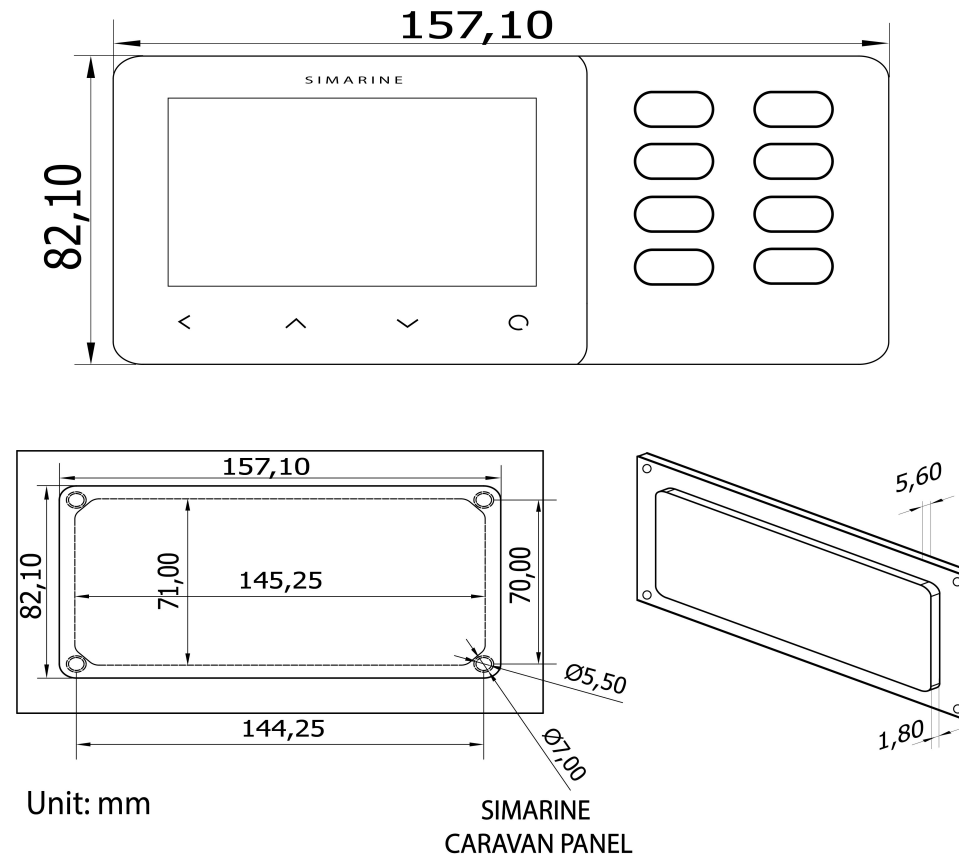

2. Accessories

VIA is compatible with the following SIMARINE modules:

- **SC303** Digital Shunt - 300A Shunt, for up to 75V systems.
- **SC503** Digital Shunt - 500A Shunt, for up to 75V systems.
- **SDI01** Inclinometer - High-resolution digital inclinometer for pitch and roll with manual calibration.
- **SCQ25** Quadro Digital Shunt Module - 4x25A Shunt, for 12V and 24V systems
- **SCQ50** Quadro Digital Shunt Module - 4x50A Shunt, for 12V and 24V systems.
- **SCQ25T** Quadro Digital Shunt and Analog input module 4x25A Shunt and Analog input module with 4 resistance and 3 voltage inputs.
- **ST107** Analog input interface module with 4 resistance and 3 voltage Inputs.



3. Safety

Electrical specialists with proper safety equipment should make installation of Simarine electronics. When working with batteries, you should wear protective clothing and eye protection.

CAUTION: Batteries contain acid, a corrosive, colorless liquid that will burn your eyes, skin, and clothing. Should the acid come in contact with eyes, skin or clothing, wash it immediately with soap under fresh water for at least 15 minutes, and seek medical support immediately.

CAUTION: Do NOT connect anything to a damaged battery. It could heat up, catch fire or explode.

CAUTION: Lead-acid batteries can generate explosive gases during operation. Never smoke, allow flames or sparks near the battery. Make sure to keep sufficient ventilation around the battery.

CAUTION: When working with a battery, remove all personal metal items like watches, rings, necklaces, and bracelets. Metal items in contact with the battery terminals might cause a short circuit with a very high electric current, which may heat up and melt nearby objects and cause severe burns.



4. Declaration of conformity



MANUFACTURER: SIMARINE d.o.o.

ADDRESS: Ulica škofa Maksimilijana Držecnika 6, SI-2000 Maribor, Slovenia, EU

Declares that the following product:

PRODUCT TYPE: V I A

Conforms to the requirements of the following Directives of the European Union:

EMC Directive 2014/30EU, RoHS Directive 2002/95/EC





The above product conforms with the following harmonized standards: EN61000-6-3: 2001 EMC - Generic Emissions Standard,

EN61000-6-2: 2005 EMC Generic Immunity Standard

5. Installation

VIA should be installed in a visible place to provide good readability. The mounting process and installation cutouts depend on the model, as described in the following sections.

Mounting steps:

1.  Before drilling, check if there is enough space to mount the panel.
2.  Mark mounting holes using the supplied installation template.
3.  Drill all holes.
4.  Connect the connector on the back of the VIA to the splitter cable (be sure to align the pins correctly) and fasten it by turning the safety ring clockwise.
5.  Finish mounting the VIA on the back side with the supplied threaded rods and nuts. Screws, rods, and nuts **MUST** be fastened by hand. Excessive force may damage the threads on the VIA.

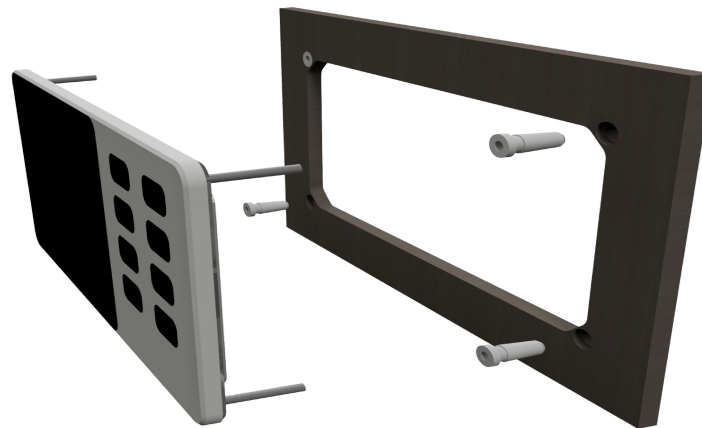

6. Basic Setup

Controlling the menus of the VIA is intuitive and easy to use. All adjustments can be performed by using the four touch buttons below the screen. Menu and settings in the picture below can differ from the menus and settings on your device since future firmware upgrades might cause some minor changes of the menus and settings.

Long press the  button to enter the settings menu.

Buttons on the right are used to open and navigate through different optional screens faster and easier. Long press the  button to turn on the device.



6.1 VIA buttons



You can enable different devices connected to the SPDU-52 by pressing the button with the corresponding symbol on the VIA (e.g. pressing the lights button will turn on the lights). You can also switch between different screens by pressing the arrow buttons on the touch screen.

There will be a separate screen for each battery with at least one connected current sensor (shunt). Multiple batteries without a current sensor (measuring voltage only) may be combined on a single screen.

Up to four tanks and four thermometers will be combined on a single screen. If there are more, they are divided into two or more screens.

Note: The button will glow when enabled.



- The Fridge button  is configured on the SPDU-52 as the first button by default (K1 on the cover scheme). Pressing the button enables the fridge
- The heating button  is configured on the SPDU-52 as the second button by default (K2 on the cover scheme). Pressing the button enables the heating.

Up to four temperature sensors can be shown on a single screen. If there are more, they are divided into two or more screens.

For each sensor, you can find its name, graphical representation of the current temperature, and the numerical value of the current temperature in the chosen unit (°C or °F).

Thermometer order, names, min. and max. ranges, and temperature units can be changed in the settings menu.

- The AC button is configured on the SPDU-52 as the third button by default (K3 on the cover scheme). Pressing the button enables the AC (air conditioning).
- The AUX button is configured on the SPDU-52 as the fourth button by default (K4 on the cover scheme). By pressing the button, you enable the output of an external device (e.g. speakers).
- The water pump button, is configured on the SPDU-52 as the fifth button by default (K5 on the cover scheme). Pressing the button enables the the water pump.
- The lights button is configured on the SPDU-52 as the sixth button by default (K6 on the cover scheme). Pressing the button enables the lights.
- If you have an inclinometer installed, pitch and roll data is displayed on the screen if you press the inclinometer button .

***Pitch** is shown on the left side of the screen. The left side of the line represents the front of the vehicle, while the right side of the line represents the back of the vehicle. The pitch angle in degrees is shown below the line (positive value meaning front facing up and vice versa).*

***Roll** is shown on the right side of the screen. The left side of the line represents the left-hand side of the vehicle. The roll angle in degrees is shown below the line (positive value meaning left-hand side up and vice versa).*

- If you long hold the power button , the device turns ON or OFF.
You can also turn the device ON or OFF by holding the  button.



6.2 Settings Screen

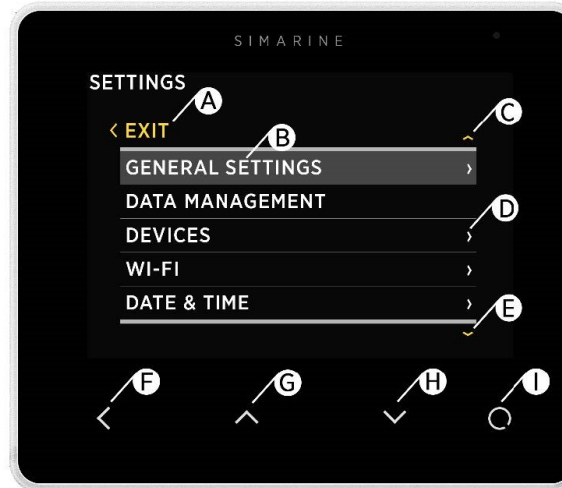

A - Label indicates current position in the menu.

B - Currently selected item.

C - Arrow indicates there is at least one more menu item in the arrow direction.

D - Arrow indicates there is a submenu.

E - Arrow indicates there is at least one more menu item in the arrow direction.

F- **BACK BUTTON**, is used to navigate one level back ore leave the settings menu.

G - **UP BUTTON** is used to navigate up in the menu or changing value or switching screens in live view.

H - **DOWN BUTTON** is used to navigate down in the menu or changing value or switching screens in live view.

I - **ENTER BUTTON**, long press activates settings, short press commits changes or enters selected submenu.

6.3 Start screen after first connection

After the installation and first connection, you should see a screen similar to the one shown below.



After the first power-on, there are no batteries and tanks displayed. Long press the  button to enter the settings menu.

6.4 Battery configuration

The VIA shows all properly configured batteries. Each correctly configured sensor will automatically show up on the VIA. The following section describes how to set up a sensor on the VIA.

6.4.1 Adding a new battery

In the settings menu navigate to **DEVICES > BATTERY**

Select “**Add new**” and fill in the requested data.

- **NAME** - Name the battery/battery bank accordingly (STARTER, SERVICE, MAIN, etc.)
- **TYPE** - Select the battery type (Wet low maintenance, Wet maintenance free, AGM, Deep cycle, Gel, LiFePO4)
- **C/20** - The declared capacity of your battery.
- **C/10** - Input only if the rating is explicitly provided by the manufacturer of your battery, otherwise leave it as “Not Set”.
- **C/5** - Input only if the rating is explicitly provided by the manufacturer of your battery, otherwise leave it as “Not Set”.

When configuring a battery bank, you have to input the ratings of the battery bank as a whole.

Example: if you have 3x 100Ah batteries connected in parallel, C20 = 3x 100Ah = 300Ah. The same rule applies for C10 and C5 ratings.

For lithium batteries, only input C20 rating and keep C10 and C5 as “Not Set”.



- **VOLTMETER** - Select a voltmeter connected to the battery. Only voltmeters that are not already used elsewhere in the configuration are displayed on the screen.

Note: Do not select PICO Internal - as this is not a calibrated voltage reading.

SETTINGS	
< VOLTMETERS	
PICO INTERNAL	11.851 ^v
SC500 [0216735249]	12.428 ^v
ST107 [0167137256] U1	0.000 ^v
ST107 [0167137256] U2	0.000 ^v
ST107 [0167137256] U3	0.000 ^v

- **AMMETERS** - Select the current sensor connected to the battery. You can select only current sensors that are not already used by another battery configuration. For a battery configuration without a shunt (voltage-only), leave ammeters empty.
- **TEMPERATURE SENSOR**- Select a temperature sensor if you have one installed and configured.
- **RANGE** - Adjust the presentation of the current reading for the battery. By default the value is set 100A and it means, that the bar used for visually representing the measured current will be displayed as full at 100A (the default range is between 0A - bar empty and 100A - bar full).
- **INSTANCE** - An identifier for NMEA2000 network. For use with NMEA2000 each battery has to have a unique instance field. Confirm and save the bank configuration with button.
- **DELETE** - With this option, you can delete the selected battery

6.4.2 Advanced settings

Advanced users may adjust some additional battery settings to customize the battery data display. It is not suggested to change these settings – the defaults should be suitable for all battery types.

- **TTG AVG** – averaging interval for calculating TTG (time-to-go). “Short” means that TTG will respond to the change in current more quickly, and “Very long” means that TTG will respond to the change in current more slowly.
- **TTG SOC MIN** – Represents a declared offset from the actual battery state. Set by default to 20% means that when PICO will display the remaining state of battery to be 0%, the actual state of the battery will be 20%. In case you want to compare PICO readings to internal battery monitoring system provided by the battery manufacturer, it is important to set this parameter to 0%, which will give you the absolute state of the battery.
- **CEF** – charging efficiency (%).
- **DISPLAY TYPE** – “Detailed” display type also shows the amp-hour counter on the batteries screen.

- **BATTERY FULL SETTINGS** - Advanced users

Any changes under these settings may cause huge offsets in precision of monitoring your battery. These settings should only be altered in extreme cases, such as if your battery is old and dying and can no longer hold the same amount of charge that is declared by the battery manufacturer. In that case, you can alter these settings, so that PICO can correctly determine when the charge in the battery reaches its full capacity.

These settings are only relevant when the battery is monitored using a shunt (current + voltage).

Here, users may set additional battery full parameters, which will be used by PICO to help determine when the battery is full.

Example:

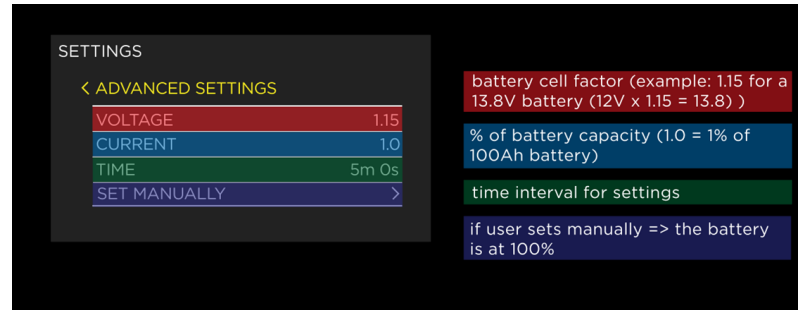

- If you have a 13,8V 100Ah battery, then you can use the settings from the picture above.
- System voltage (12V) x factor (1.15) = 13,8V -> your battery full voltage.
- Battery capacity (100Ah) 1.0 is a % factor of the battery capacity (1.0 = 1Ah = 1%).
- Time -> This setting is a determined time interval for how long both conditions (voltage, current) need to take place for the battery to be determined as full (100%).

Set manually -> Use this to calibrate the battery's state of charge to 100%. You should use this functionality only when the battery is actually full. Once you select this option, the PICO will note the battery as full and after that it will rely on the calculations based on the input/output current readings.

Execute the calibration when you are sure that the battery fullness is at 100%.

PICO uses an algorithm which tries to find the starting state of charge of the battery after the configuration. For lithium batteries it is highly recommended, that you calibrate the battery manually after you configure it.

6.5 Tank configuration

The VIA shows all properly configured tanks. Each correctly configured sensor will automatically show up on the VIA. The following section describes how to set up a sensor on the VIA.

6.5.1 Adding a new tank

After connecting a tank sensor to an appropriate module (ST107, SC303/503, SCQ25T) input, you can configure the tank by following these steps:

In the settings menu, navigate to **DEVICES > TANKS**. Select "**Add new**" and fill in the requested data:

- **NAME** - Name the tank accordingly
- **TYPE** - Select the tank type (WATER, FUEL, WASTEWATER), which defines the color of the tank on Pico's screen.
- **SENSOR TYPE** - Select the used sensor's type (RESISTANCE or VOLTAGE)
- **SENSOR** - Select the used sensor input from the Only resistance/voltage inputs that are not already used elsewhere in the configurations will be displayed on the screen.

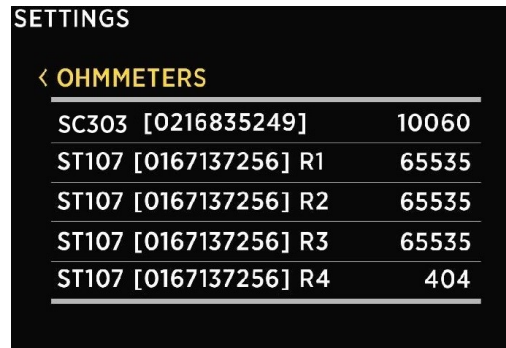

SETTINGS		
< OHMMETERS		
SC303 [0216835249]		10060
ST107 [0167137256] R1		65535
ST107 [0167137256] R2		65535
ST107 [0167137256] R3		65535
ST107 [0167137256] R4		404

- **CAPACITY** - Input the full tank capacity.
- **CALIBRATION POINTS** - Add calibration points for different tank levels. For a proper configuration at least two calibration points are required.
For square shaped tanks we suggest two calibration points (full and empty).
For irregular shaped tanks, we suggest you input a third (the middle) point. The rest will be calculated by PICO on the fly.

- **DISPLAY PRIORITY** – Set the display priority of the tank (this is practical only when there are multiple tanks configured)
- **DISPLAY MODE**
 - Standard – displays tank content in measuring unit and percentage.
 - Fewer data - display tank content only in percentage
- **INSTANCE** – An identifier for NMEA2000 network. For use with NMEA2000 each tank has to have a unique instance field. Confirm and save the tank configuration with  button.

The newly added tank should now be visible on one of the PICO's screens, once you exit the settings menu (visible on the main menu screen).

COMPATIBLE TANK SENSORS:

Any analog voltage/resistance type tank sensor, that is made for general use and not locked to a specific tank level monitor, will work with the SIMARINE system.

The compatible ranges are:

Resistance: 0 Ohm - 65000 Ohm (65kOhm) or anything in between.

Voltage: 0.0V - 70.0V or anything in between.



6.6 Temperature sensor configuration

The VIA shows all properly configured temperature sensors. Each correctly configured sensor will automatically show up on the VIA. The following section describes how to set up a sensor on the VIA.

6.6.1 Add a new temperature sensor

In the settings menu, navigate to **DEVICES > TEMPERATURE SENSORS**. Select “**Add new**” and fill in the requested data.

- **NAME** - Name the temperature sensor
- **TYPE** - Select the type of the sensor:
 - NTC 10k (down to -13°C / 8.6°F)
 - NTC 5k (down to -20°C / -4°F)
 - NTC 1k (down to -40°C / -40°F)
- **DEVICE** - Select the resistance input to which your temperature sensor is connected to.
- **DISPLAY PRIORITY** - Set the display priority of the temperature sensor (this is practical only when there are multiple temperature sensors configured)
- **RANGE (MIN / MAX)** - Select the minimum and maximum temperature point displayed on the temperature graph.
- **CALIBRATION** - Set the temperature offset if necessary.
- **SOURCE** - Define the source of the temperature reading for use with NMEA2000 network.
- **INSTANCE** - An identifier for NMEA2000 network. For use with NMEA2000 each temperature sensor has to have a unique instance field.

6.7 Inclinometer configuration

The VIA shows all properly configured inclinometers. Each correctly configured sensor will automatically show up on the VIA. The following section describes how to set up a sensor on the VIA.

6.7.1 Adding a new inclinometer

SIMARINE DIGITAL INCLINOMETER MODULE DOES NOT REQUIRE ADDING A NEW INCLINOMETER OR INPUTTING ANY SETTINGS, AS THAT WILL BE ADDED AUTOMATICALLY WHEN SD01-DIGITAL INCLINOMETER IS CONNECTED TO THE SYSTEM (Plug&Play).

In case you are using some other analog inclinometer, you will have to configure it manually.

Although, when using the Digital Inclinometer, you do not have to configure any settings as it is Plug&Play device, you can adapt some settings to your liking (relevant properties are marked with "***").

In the settings menu, navigate to **DEVICES > INCLINOMETERS**.

Select **"Add new"** and fill in the requested data.

- **NAME **** - Select name of the inclinometer (PITCH / ROLL).
- **SENSOR** - Select a voltage input to which you connected your analogue inclinometer to.
- **NONLINEAR **** - Enabling this property will make smaller angles to be presented in a non linear way, so that it is easier for a user to see the measured angle presented with the lines on the inclinometer screen.
- **RANGE** - Select the range on which the output range of your analogue inclinometer (0-5V / 0-10V)
- **DISPLAY **** - You can toggle if the inclinometer is displayed on the inclinometer screen.
- **REVERSE **** - With this option you can reverse the inclinometer readings
- **DELETE** - With this option, you can delete the selected inclinometer sensor.

6.8 User sensor configuration

The VIA shows all properly configured user sensors. Each correctly configured sensor will automatically show up on the VIA. The following section describes how to set up a sensor on the VIA.

6.8.1 Adding a user sensor

In the settings menu, navigate to **DEVICES > USER SENSORS**.

Select “**Add new**” and fill in the requested data.

- **NAME** - Name the user sensor.
- **VOLTMETER** - Select the voltage input used to measure the analog output of your voltage type user sensor.
- **LOW VALUE POINT** - What value is presented by the LOW VOLTAGE POINT (see bellow).
- **HIGH VALUE POINT** - What value is presented by the HIGH VOLTAGE POINT (see bellow).
- **RANGE (MIN/MAX)** - Determines the color of the bar. At 75% the color of the bar will turn RED.
- **DECIMALS** - Set an offset of the decimal point (from right to left).
- **MEASUREMENT UNIT** - Input the measurement unit that will be presented on the display graph.
- **LOW VOLTAGE POINT** - Expected voltage when the sensor measures its lowest value.
- **HIGH VOLTAGE POINT** - Expected voltage when the sensor measures its highest value.
- **DELETE** - With this option, you can delete the selected user sensor.



6.9 Current sensor configuration

The VIA shows all properly configured current sensors. Each correctly configured sensor will automatically show up on the VIA. The following section describes how to set up a sensor on the VIA.

6.9.1 Adding a current sensor

List of all current sensors (shunts). Connected shunt modules are added to the list automatically. In this list, you can view real time readings (amperes) for all connected current sensors. By selecting a certain sensor, you can **view** or **change** its settings.

SETTINGS	
< CURRENT SENSORS	
SC303 [0216835249]	-1.01 ^A
SCQ25[0437773054] 1	1.04 ^A
SCQ25[0437773054] 2	0.00 ^A
SCQ25[0437773054] 3	0.00 ^A
SCQ25[0437773054] 4	0.00 ^A

Pressing the enter button will open a settings screen for the selected sensor.

NAME - Assign a display name of the current sensor.

RANGE - Adjust the presentation of the current reading for the current sensor. By default the value is set 100A and it means, that the bar used for visually representing the measured current will be displayed as full at 100A (the default range is between 0A - bar empty and 100A - bar full).

REVERSE CURRENT - For consumers the current reading should be a negative number measured and for generators it should be a positive number measured and displayed on the CURRENT SENSORS screen. In case of reverse wiring, the situation might be exactly the opposite. This can be resolved either by rewiring the shunt or - easier - by toggling this option.

ADD CURRENT - Determines if the measured current should be used in the calculation of the state of charge for the battery to which this shunt is assigned to.

In case there are multiple shunts in the system it is important to watch out for a possible "double current" problem (when the same current is calculated twice). This happens if the same current passes through multiple shunts. Example: a fridge is monitored individually with a dedicated current sensor, but the same current passes also through the main battery shunt. In such case, we should configure the monitor so that it will calculate only the current of one of the sensors, while the purpose of the other sensor is purely the convenience of the user to see the device's consumption (individual device monitoring).

BATTERY - Here you can assign your shunt to a battery. More common way is to assign shunts to a battery through the battery configuration screen.

DISPLAY SEPARATELY - If enabled, the shunt will be displayed in separate screen, even if the shunt is assigned to a battery.

DISPLAY PRIORITY - Set the display priority of the current sensor. Here you can also hide the current sensor.

DEVICE - Displays a full ID of the current sensor. This is read only and it will not change even if you rename the sensor.

MERGE WITH - Gives you an option to merge the sensor with another sensor. That way you tell PICO to consider the readings of two current sensors as a reading of a single device.



7. Device configuration

You can enter the settings menu by long pressing the  button. To navigate through the list, use up and down arrow buttons. To select an item, press the **enter button**. To navigate one level back, use **the back button**.

7.1 General settings

This menu offers screen, language, units, and sleep settings.

7.1.1 Screen

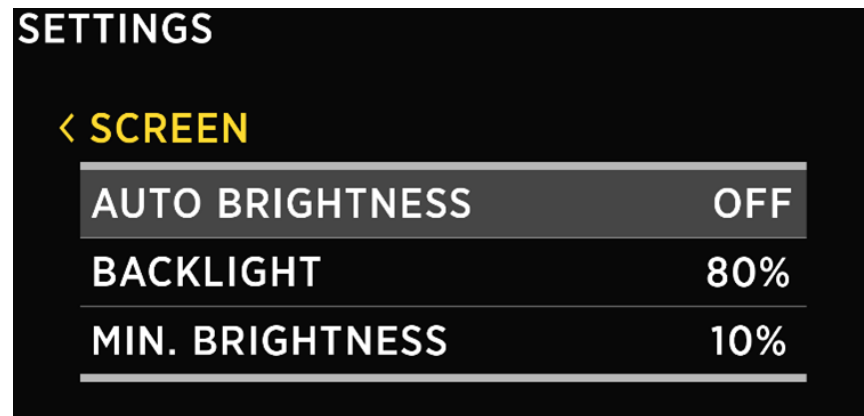

AUTO BRIGHTNESS - When auto-brightness is enabled, the internal light sensors automatically adjust the screen brightness to match the ambient lighting conditions.

BRIGHTNESS - The brightness level used during normal operation. When AUTO BRIGHTNESS is enabled, this is the maximum brightness level.

MIN. BRIGHTNESS- Min. brightness has two functions.

1. When PICO is in sleep mode, the illumination is set to min. brightness level.
2. When AUTO BRIGHTNESS is enabled, it defines the minimum illumination.

7.1.2 Device

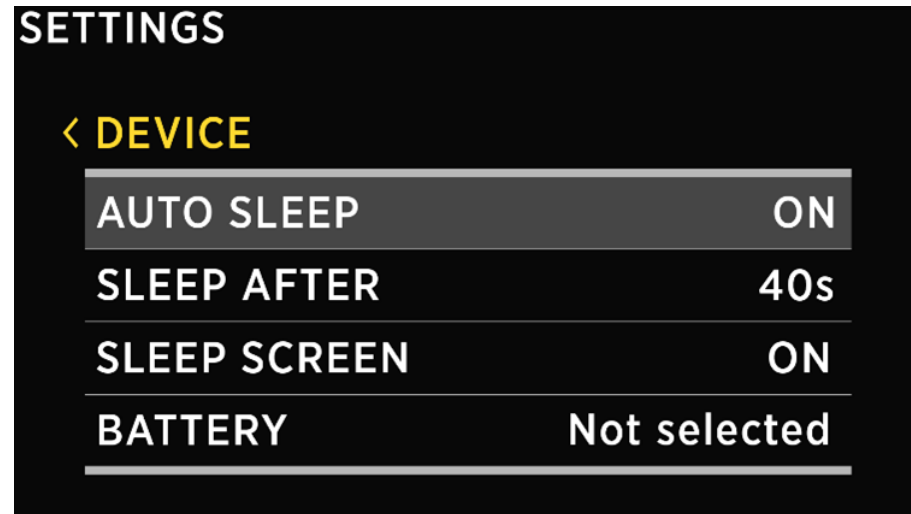

- **AUTO SLEEP** - Enable/Disable auto sleep function.
- **SLEEP AFTER** - Time after which the VIA goes into sleep mode if the AUTO SLEEP setting is enabled.
- **SLEEP SCREEN** - If SLEEP SCREEN is enabled the VIA will display home screen when in SLEEP MODE.
- **BATTERY** - This determines which battery will be displayed on the home screen.
- **POWER MANAGEMENT --> AUTO POWER OFF** - Automatically powers off the VIA, if this is **ON**.
- **POWER MANAGEMENT --> AUTO POWER OFF DELAY** - Automatically powers off the VIA after selected time.

7.1.3 Language

You can choose between English, German, French, Spanish and Polish languages. More languages will be added with future firmware upgrades.

7.1.4 Units

You can choose different international measurement units for **pressure, temperature, volume, altitude and speed**.

7.2 Data management

This menu enables you to set up alarms for certain measurements. Here, you can choose the quantity, the device, low and high values for alarm, and you can turn the high/ low-value alarms on and off.

- **ALARM LOW:** Low-value alarm fires when the measured value is lower than the setup **alarm value**.
- **ALARM HIGH:** High-value alarm fires when the measured value is higher than the setup **alarm value**.

After you select **ALARM LOW** or **ALARM HIGH**, the following alarm settings will appear:

- **ALARM STATE** - enable and disable alarm.
- **ALARM VALUE** - a limit value which fires the alarm.
- **SILENT**, if enabled, there will be no audible signal when the alarm fires. The alarm warning will only appear on PICO's screen.
- **ALARM DELAY**, the time delay with which the alarm is fired. The alarm fires when only the measured value is below (for alarm low) or above (for alarm high) the "alarm value" during the delay period.
- **ALARM DURATION**, the selected alarm duration. 5 minutes by default. Setting the duration to 0 seconds will keep the alarm active until manually dismissed.
- **OUTPUT** - the digital output that is turned on during an active alarm.
- **OUTPUT MODE** -
 - **ON / OFF** - It will toggle the alarm ON/OFF depending on the alarm value.
 - **ON** - It will toggle the alarm ON when the alarm value is reached.
It will not turn OFF when the conditions are no longer met.
 - **OFF** - It will toggle the alarm OFF when the alarm value is reached.
It will not turn ON when the conditions are no longer met.
- **OUTPUT DELAY** - Time delay of firing the alarm output after the alarm conditions are met.

7.2.1 Alarm screen

When an alarm is triggered it is shown on the VIA (see image below). From there you can control the alarm state.

Hide, which hides the alarm from the display.

Snooze, for 5 or 30 minutes, which means it is hidden for 5 or 30 minutes and then displayed again if still active. The output is active (if configured).

Dismiss, turns the alarm and output (if configured) off for 24 hours.

When multiple alarms are active, at the same time, then they are alternately displayed.



If at least one alarm is active, then an alarm entry on top in the menu settings is displayed. From there you can view all currently active alarms.

7.3 Devices

Here you can manage all the devices connected to your VIA. When you connect a new module to your VIA system (e.g. a new shunt), some new devices will automatically appear on the device list (e.g. current sensors, voltmeters, ohmmeters, etc.). These devices automatically appear because they are integrated into the modules. But “secondary” devices - those that are connected to the modules (BATTERIES, TANKS, THERMOMETERS, and analog INCLINOMETERS) - will not be added automatically. If you connect a new battery, tank, or thermometer, you have to add and configure the new device manually in the DEVICES menu.

Devices are classified into device types.

To view, manage, add, or delete a specific device, please select the corresponding device type from the list (e.g. BATTERIES, TANKS, etc.).

7.3.1 Batteries

List of batteries that you have added to your VIA. By selecting a specific battery, you can view or change its settings or delete the battery if necessary. By selecting “**Add new**”, you can add a new battery. For more information go to [Adding a new battery](#).

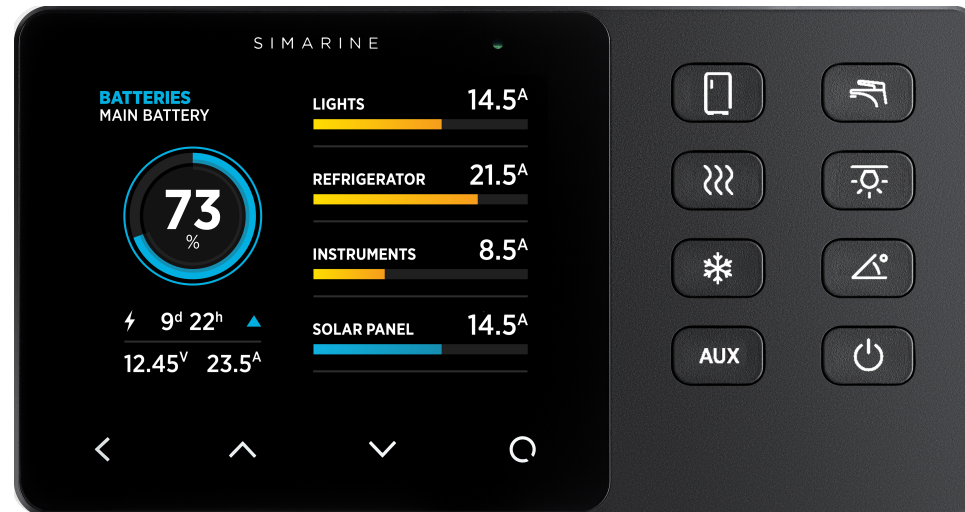

If the battery connects only to a voltage sensor (without a current sensor), the battery name, approximate state-of-charge (SOC), and current-voltage are displayed. The calculation of SOC takes some time, so it may not be shown immediately after power-on.

Up to three batteries without a current sensor can be shown on a single screen. If there are more, they are divided into two or more screens.

If the battery is connected to a voltage sensor and a single current sensor (shunt), some additional data is displayed: time to charge, time to discharge, and electrical current (amps). SOC can be calculated more accurately if a current sensor is connected. Time to discharge is calculated by using an average consumption during a specific period.

If there are more than one current sensor (shunt) connected to the battery (e.g. for monitoring different consumers or generators connected to the battery), their data (amps) is also shown on the battery page.

! Caravan's algorithm for calculating state-of-charge (SOC) is not a simple Ah-counter. It is constantly monitoring battery current, voltage, and temperature. This data is compared to the internal battery model and its parameters are constantly being adjusted so that the model fits the actual data. The algorithm needs some time to adjust the parameters (learning phase) and it will improve accuracy during the first few cycles.

! After adding a new battery or changing settings of an existing battery, the algorithm for calculating state-of-charge (SOC) needs some time to adjust the parameters of its battery model (learning phase). It will improve accuracy during the first few cycles.



7.3.2 Tanks

List of tanks you have added to your VIA. By selecting a specific tank, you can view or change its settings or delete it if necessary. By selecting “Add new”, you can add a new tank. For more information go to [Adding a new tank](#)^[29].



7.3.3 Temperature sensors

List of temperature sensors that you have added to your VIA. By selecting a specific sensor, you can view or change its settings or delete it if necessary. By selecting “Add new”, you can add a new temperature sensor. For more information go to [Adding a new temperature sensor](#)^[31].

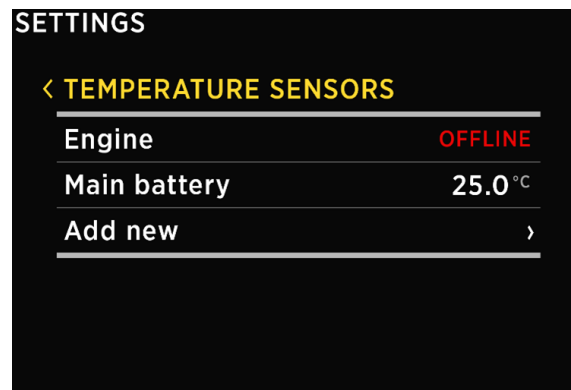

7.3.4 Current sensors

List of current sensors that you have added to your VIA. By selecting a specific sensor, you can view or change its settings or delete it if necessary. By selecting “Add new”, you can add a new current sensor. For more information go to [Adding a current sensor](#)^[34].

SETTINGS	
< CURRENT SENSORS	
SC303 [0216835249]	-1.01 ^A
SCQ25[04377773054] 1	1.04 ^A
SCQ25[04377773054] 2	0.00 ^A
SCQ25[04377773054] 3	0.00 ^A
SCQ25[04377773054] 4	0.00 ^A

7.3.5 Voltmeters

List of all voltmeter sensors connected to your VIA. Connected voltmeters are added to the list automatically. You cannot manually add a new voltmeter.

In this list, you can view current readings (voltages) for all connected voltmeters.

SETTINGS	
< VOLTMETERS	
PICO INTERNAL	11.851 ^V
SC500 [0216735249]	12.428 ^V
ST107 [0167137256] U1	0.000 ^V
ST107 [0167137256] U2	0.000 ^V
ST107 [0167137256] U3	0.000 ^V

7.3.6 Ohmmeters

List of all ohmmeters connected to VIA. Connected ohmmeters are added to the list automatically. You cannot manually add a new ohmmeter. In this list, you can view current readings (resistance in ohms) for all connected ohmmeters.

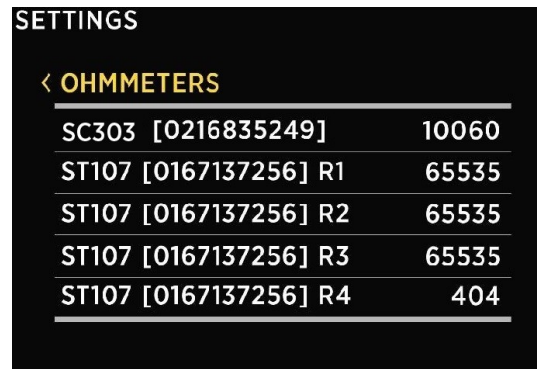

SETTINGS	
< OHMMETERS	
SC303 [0216835249]	10060
ST107 [0167137256] R1	65535
ST107 [0167137256] R2	65535
ST107 [0167137256] R3	65535
ST107 [0167137256] R4	404

7.3.7 Coulomb counter

For each connected current sensor, a corresponding Coulomb counter will also appear on the devices list. Each Coulomb counter shows a total electric charge (in Ah, amp hours) that has transferred through this sensor until now. By selecting a certain Coulomb counter, you can manually reset the counter to zero.

7.3.8 Inclinometers

List of all voltmeter sensors connected to your VIA. Connected voltmeters are added to the list automatically. You cannot manually add a new voltmeter.

In this list, you can view current readings (voltages) for all connected voltmeters.



7.3.9 User Sensors

List of custom sensors that you have added to your VIA. By selecting a specific sensor, you can view or change its settings or delete it if necessary. By selecting “**Add new**”, you can add a custom user sensor. For more information go to [Adding a new user sensor](#)^[33].

7.3.10 Control unit

For control unit configuration please see the [Panel and Power Unit configuration](#)^[54] page.

7.3.11 Power unit

For power unit configuration please see the [Panel and Power Unit configuration](#)^[54] page.

7.4 WI-FI

This menu offers all the Wi-Fi settings for your VIA.

OPERATION - When set to ON, Wi-Fi module is enabled. Otherwise, it is disabled, and no configuration data is displayed.

MODE - The PICO supports **AP** mode which stands for the **access point** and **STA** mode for **station mode**.

7.4.1 AP Mode

When in AP mode, the VIA creates its wireless network. If you want to connect to it with your smartphone, please connect to the network whose name corresponds to SSID setting value. Wireless network password can be changed with PASSWORD setting.

Example: if your VIA's serial number is 1234567890, then the default Wi-Fi SSID is sc567890 and the password is sc123456.

7.4.2 STA Mode

When in STA mode, you can connect the VIA to your local router and connect with your smartphone via a router. This mode enables more than one mobile app connecting to the VIA at the same time.

To set up STA mode take the following steps:

- Under MODE select STA mode.
- Under SSID find and select your router.
- VIA detects the security type, select password, and type in the WIFI password.
- After this select connect and wait for VIA to connect.





7.3.9 User Sensors

When in STA mode, you can connect the VIA to your local router and connect with your smartphone via a router. This mode enables more than one mobile app connecting to the VIA at the same time.

To set up STA mode take the following steps:

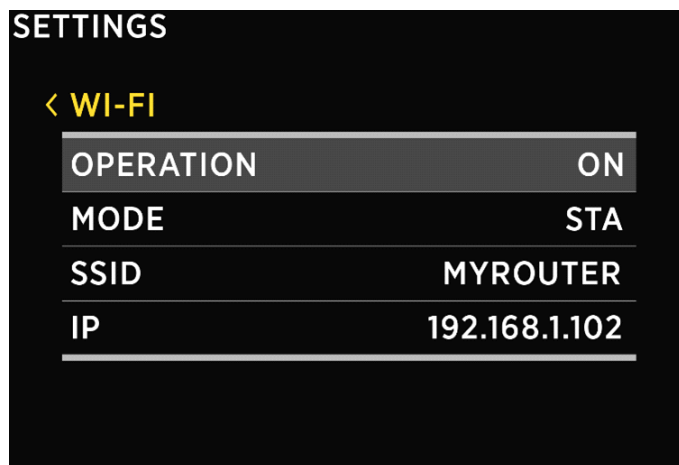
- Under MODE select STA mode.
- Under SSID find and select your router.
- VIA detects the security type, select password, and type in the WIFI password.
- After this select connect and wait for VIA to connect.



 If the VIA can't find your router SSID, check if SSID broadcasting is enabled on your router.

 The Dynamic Host Configuration Protocol (DHCP) should be enabled on the router to assign an IP address dynamically.

7.5 Date & Time

In this menu, you can set the time, date, and time zone manually, but we do not recommend this, because these values will be overridden by your smartphone settings each time you connect the phone to your VIA and start the SIMARINE application.

The exact time is important for the proper functioning of the device, so it is synchronized with your phone every time it is connected.

However, the time and the date format settings can be changed at will, because your phone settings will not override them.

TIME - Set the current time. The value is overridden each time you connect the phone to your VIA and start SIMARINE application.

DATE - Set the current date. The value is overridden each time you connect the phone to your VIA and start SIMARINE application.

TIME ZONE - Set the current time zone. This value is overridden each time you connect the phone to your VIA and start SIMARINE application.

TIME FORMAT - You can choose your desired time format from the list.

DATE FORMAT - You can choose your desired date format from the list.



7.6 Service

Under this section you can find information about the following:

SETTINGS LOCKED - Here, you can lock the settings of the VIA. A PIN will be required to unlock the settings in the future. To lock the settings of the VIA, select **ON**, to keep the settings unlocked, select **OFF**.

MAIN SCREEN - Change what will be displayed on the main screen.

DEBUG SCREEN - Opens the debug menu, listing all the services and displaying whether the service is running (1) or not (0).

SYSTEM RESET - Deletes all the devices from the VIA. When clicked on, it will demand a PIN code, the code 1 2 3 4 1 2, after that you can factory reset the VIA with long pressing the  button.

7.7 System

Under the SYSTEM section you can find the following information:

COMMUNICATION DEVICES - List of all the devices (modules) that are connected to the VIA, together with the bus communication quality (%).

SYSTEM INFO - Displays the VIA's serial number, currently installed **firmware version** and **free memory**.



8. Panel and Power Unit configuration

VIA supports assigning which button controls which relay. User can either configure an identifier of a specific button or an identifier of a specific relay.

**You can adjust the buttons on MENU > DEVICES > CONTROL UNIT > SCC8 screen.
The default configurations are:**

BUTTON 0
INSTANCE = 1
MODE = TOGGLE
SCREEN = OFF

BUTTON 1
INSTANCE = 2
MODE = TOGGLE
SCREEN = OFF

BUTTON 2
INSTANCE = 3
MODE = TOGGLE
SCREEN = OFF

BUTTON 3
INSTANCE = 4
MODE = TOGGLE
SCREEN = OFF

BUTTON 4
INSTANCE = 5
MODE = TOGGLE
SCREEN = OFF

BUTTON 5
INSTANCE = 6
MODE = TOGGLE
SCREEN = OFF



BUTTON 6
INSTANCE = 7
MODE = TOGGLE
SCREEN = OFF

BUTTON 7
INSTANCE = 8
MODE = TOGGLE
SCREEN = OFF

The default mapping instance properties of the is therefore:

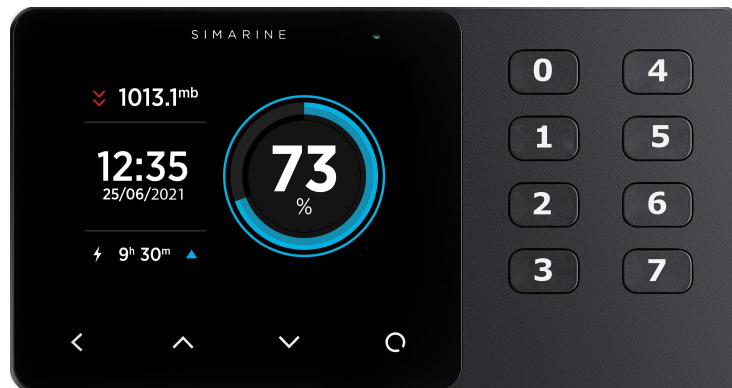

Make sure that the same instance property is not shared by multiple buttons.

You can adjust the relays (OUTPUTS) on MENU > DEVICES > POWER UNIT > SPU62 [...] > OUTPUTS screen.
The default configurations are:

OUTPUT 0
INSTANCE = 1
STARTUP STATE = OFF

OUTPUT 1
INSTANCE = 2
STARTUP STATE = OFF

OUTPUT 2
INSTANCE = 3
STARTUP STATE = OFF

OUTPUT 3
INSTANCE = 4
STARTUP STATE = OFF

OUTPUT 4
INSTANCE = 5
STARTUP STATE = OFF

OUTPUT 5
INSTANCE = 6
STARTUP STATE = OFF

The default mapping instance properties of the outputs (RELAYS) is therefore:

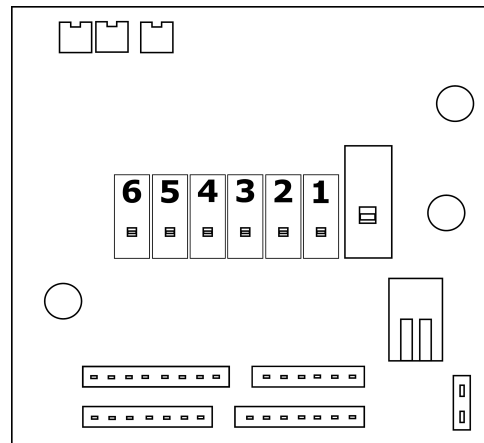

Make sure that the same instance property is not shared by multiple outputs (RELAYS).

8.1 Configuring a button to display a specific screen

You can configure a button so that a specific monitoring screen will be display when the button is pressed.

The following configurations displays an inclinometer screen when the user presses the button 6 (7).

Navigate to **MENU > DEVICES > CONTROL UNIT > SCC8 >**

Select **BUTTON 6**

INSTANCE (the value can remain as it is)

MODE = Set mode to **DISPLAY**

SCREEN = Select **INCLINOMETER**

You can configure a button to display INCLINOMETER, TANK or BATTERY screen.

It is also possible to display a specific screen and at the same time toggle a relay. An example of that would be the following configuration of BUTTON5, which would start the water pump (for instance) and at the same time display the TANK screen.

BUTTON 5

MODE = TOGGLE

SCREEN = TANKS

The changes will take place, when you leave the menus.

8.2 Configuring a button to toggle a different relay

You can configure a button so that a specific monitoring screen will be display when the button is pressed.

The following configurations swaps the functionality of BUTTON 0 (which by default toggles OUTPUT 1) with that of the BUTTON 1 (which by default toggles OUTPUT 2).

Make sure that the same instance property is not shared by multiple buttons.

Navigate to **MENU > DEVICES > POWER UNIT > SPU62 [...] > OUTPUTS.**

The default values for BUTTON 0 and BUTTON 1 are:

BUTTON 0

INSTANCE = 1
MODE = TOGGLE
SCREEN = OFF

BUTTON 1
INSTANCE = 2
MODE = TOGGLE
SCREEN = OFF

Here you can swap the functions of these two buttons by swapping the INSTANCE field:

BUTTON 0
INSTANCE = 2
MODE = TOGGLE
SCREEN = OFF

BUTTON 1
INSTANCE = 1
MODE = TOGGLE
SCREEN = OFF

The changes will take place, when you leave the menus.

9. Mobile App

Your smartphone can remotely control the VIA through Wi-Fi connection. Using the app, you can monitor current (live) data for batteries, tanks and thermometers. You can also change the VIA settings on your smartphone, and upgrade **Simarine firmware** to the latest version.

Find your **Simarine – application** in your mobile store by scanning the QR code below or visiting below link for your app store.



[Simarine App on Google Play](#)



[Simarine App on the App Store](#)

10. Save and restore settings

Using your mobile app, you can save your current VIA settings to your phone, and you can restore your saved settings from your phone to your VIA.

Save settings. To save settings, open your PICO mobile app and connect to your PICO. In the SETTINGS menu, choose **SAVE BACKUP**. Name your settings and tap **OK**. Your settings are then saved.

Restore settings. If you want to restore your PICO settings, open your PICO mobile app and connect to your PICO via Wi-Fi. In the SETTINGS menu, choose **RESTORE BACKUP**. A list of saved backups will appear, together with a date and time when these settings saved. Select a desired record from the list and tap **RESTORE**. You will be asked to confirm your action. After pressing **RESTORE** once again, wait a few seconds for your settings to restore.

! You can restore to your previously saved settings if your VIA's physical configuration has not been changed (no shunts or modules have been added or removed). If your VIA's physical configuration has changed, you will not be able to restore to the settings that had been saved before the configuration has changed.
Before executing SYSTEM RESTORE make sure you do a SYSTEM RESET - which will erase any existing configurations.

If you use the same VIA physical configuration (the same number of modules and shunts) on multiple VIA monitors, it is also possible to transfer the settings from one to another by using the same procedure.



11. Firmware upgrade

To ensure the best VIA experience, we recommend upgrading the firmware to the latest version. You can do this via **Simarine application**, available on your smartphone application market as described in chapter [Mobile application](#)⁶⁰.

! It is important to install the latest Simarine Application (or to update your installed application to the latest version) before proceeding with the firmware upgrade

The upgrade process requires the following steps:

1. Install or update the Simarine application – Simarine application on your smartphone.
2. Turn on Wi-Fi on your VIA.
3. Connect your smartphone to VIA through Wi-Fi.
4. Launch the phone application.
5. Go to the settings menu and tap > **DEVICE SETTINGS** > **FIRMWARE UPGRADE** and confirm the upgrade.
6. The upgrade process will put your VIA device in the **upgrade mode**.
7. Long press the  button on your VIA to confirm the firmware upgrade. The upgrade process can take a few minutes to complete.
8. After the upgrade, VIA reboots and is ready to use.

If there is no **FIRMWARE UPGRADE** option in the application menu (step 5), please make sure that you have **updated** your App to the **latest version**.

Emergency mode firmware upgrade procedure:

1. Turn VIA OFF and back ON again (may require toggling power to the VIA, see note bellow)*.
2. As soon as the start-up logo appears press and hold the left arrow key until VIA enters in text-only mode.
3. Connect your smartphone to VIA through Wi-Fi. A blue line of text will appear on VIA as soon as the connection is established.
4. Launch the phone application.
5. Wait for a red button labeled "FIRMWARE UPGRADE" to appear and press it.
6. Confirm the upgrade if prompted by the application.
7. After the upgrade, VIA reboots and is ready to use.

12. Technical specifications

Operating	
Voltage range	6 - 22V
Temperature range	-20°C - 70°C (-4°F - 158°F)
Power consumption at 12V	
Operating, Wi-Fi on, 100% illumination	100mA
Operating, Wi-Fi off, 70% illumination	40mA
Stand by, Wi-Fi off, 0% illumination	22mA
Power off, Logger still active	5mA
Display capabilities	
Current	
Range	-999.99 to +999.99A
Resolution	0,01 A
Voltage	
Range	0 - 75VDC



Resolution	0,001 V
Amp hours (Ah)	±0,1 Ah
Temperature	
Range	-40°C to + 150°C
Resolution	0,1 °C / °F
SOC - State of charge	0 - 100%
WiFi	
Radio frequency bands	2.4GHz
Dimensions (without connector)	
VIA	157.10 x 82.10 x 5.60mm
	6.18 x 3.23 x 0.22in
Connectivity	Up to
Batteries	6
Shunts	24
Temperature sensors	10



Tank level sensors	14
Inclinometer sensors	2



S I M A R I N E

Safe Voyage.