

Yacht Devices

User Manual

NMEA 2000 USB Gateway YDNU-02
also covers models

YDNU-02RM, YDNU-02RF, YDNU-02NM, YDNU-02NF

Firmware version

1.25

2019

© 2019 Yacht Devices Ltd. Document YDNU02-008. February 14, 2019. Web: <http://www.yachtd.com/>

NMEA 2000® is a registered trademark of the National Marine Electronics Association. SeaTalk NG is a registered trademark of Raymarine UK Limited. Garmin® is a registered trademark of Garmin Ltd. ActiSense® is a registered trademark of Active Research Ltd.

Contents

Introduction	4
Warranty and Technical Support	6
I. Product Specification	7
II. Installation of Device and Connection to NMEA 2000 Network	9
III. Installation of USB Drivers and Connection to PC	12
IV. LED Signals	20
V. Configuration of Device Operation Modes	22
VI. Terminal Access to Service Menu	24
VII. Service Menu Commands and Device Settings	27
VIII. Recording of Diagnostics Data	36
IX. Firmware Updates	38
X. Programming Considerations	40
XI. Autopilot Control and Settings	42
APPENDIX A. Troubleshooting	45
APPENDIX B. Device Connectors	46
APPENDIX C. NMEA 2000 Messages Supported by Device	47
APPENDIX D. Conversions Between NMEA 2000 and NMEA 0183	48
APPENDIX E. Format of Messages in RAW Mode	56
APPENDIX F. Format of Messages in N2K Mode	58

Package Contents

Device	1 pc.
This Manual	1 pc.
USB Cable	not supplied
NMEA 2000 Drop Cable	not supplied

Note: Device can be connected to the network backbone directly, without a NMEA 2000 drop cable.

Introduction

The NMEA 2000 USB Gateway (hereinafter Gateway or Device) allows you to see data from a NMEA 2000 marine digital network on a PC, laptop or tablet PC with Microsoft Windows, Mac OS or Linux operation system. With it, you get marine network data including vessel course, speed, position, wind speed and direction, water depth, AIS messages from vessels and aircrafts and other navigation data in PC applications like OpenCPN, Expedition, Coastal Explorer, Polar View, OpenSkipper, etc.

NMEA 0183 applications can use \$PCDIN and \$MXPGN sentences to transmit raw NMEA 2000 messages to and from NMEA 2000. This allows receiving of extended engine data, data from tanks and batteries, and gives control over NMEA 2000 digital switching equipment.

The Device can be configured to work in one of the following operation modes:

- **0183.** In this mode, the Device performs conversion from NMEA 2000 (binary protocol) to NMEA 0183 (text based protocol) and vice versa. NMEA 0183 is a very old and very popular protocol supported by virtually all marine PC applications. Conversion from NMEA 2000 covers all significant data, including AIS (see Appendix C for details).
- **RAW.** Device sends all messages from NMEA 2000 to PC and vice versa in readable text format, similar to the format of NMEA 2000 logs used in chart plotters (see examples in Appendix E). This format can be useful to diagnose a network or to create your own applications, supported in Expedition 10 and CAN Log Viewer software.
- **N2K.** Device sends all messages from NMEA 2000 to PC and vice versa in a binary form and is compatible with Coastal Explorer, Polar View, OpenSkipper and some other marine software. The protocol is very similar to Garmin Serial Protocol and partially compatible with ActiSense NGT protocol (see Appendix F for details).
- **AUTO.** In this mode, the Device analyzes the connection with the PC application and automatically chooses one of the three modes above for the session. Devices with the factory settings use this mode and we recommend keeping this setting.

The Device connects to PC by USB cable and is compatible with USB 1.1 and higher. At the software level,

the Device is a virtual COM port (USB device class 2, subclass 2). In Mac OS X, Linux and Windows 10, such devices do not require a special driver; the operating system automatically uses a system driver. In older Microsoft Windows versions, you will need to install a driver.

The Device does not require any special software. You can select the preferred operation mode or initiate recording of diagnostics data using an operation system command line. To update the firmware, you just need to send an update file to the Device's port with a «copy» (MS-DOS and Microsoft Windows) or «cp» (Linux and Mac OS X) command. With any terminal program, you can get access to a service menu, where you can configure filters for received and transmitted messages and tune some other settings.

The Gateway:

- can be used in any operation system;
- does not require special driver software;
- all protocols are open and described in this Manual;
- in N2K and RAW modes, a Device can pass any message (including proprietary messages) between NMEA 2000 and a PC application;
- in 0183 mode, provides compatibility with very old marine applications;
- have special settings to control Raymarine SeaTalk NG autopilots from NMEA 0183;
- supports firmware updates and diagnostic data recording;
- provides high-voltage galvanic isolation between NMEA 2000 and USB interfaces;
- employs an IP67 waterproof USB connector (not in all models) for use outside.

We hope that it is the best gateway that you've ever tried. Thank you for purchasing our product and happy voyages!

Warranty and Technical Support

1. The Device warranty is valid for two years from the date of purchase. If a Device was purchased in a retail store, the sales receipt may be requested when applying for a warranty claim.
2. The Device warranty is terminated in case of violation of the instructions in this Manual, case integrity breach, or repair or modification of the Device without the manufacturer's written permission.
3. If a warranty request is accepted, the defective Device must be sent to the manufacturer.
4. The warranty liabilities include repair and/or replacement of the goods and do not include the cost of equipment installation and configuration, or shipping of the defective Device to the manufacturer.
5. Responsibility of the manufacturer in case of any damage as a consequence of the Device's operation or installation is limited to the Device cost.
6. The manufacturer is not responsible for any errors and inaccuracies in guides and instructions of other companies.
7. The Device requires no maintenance. The Device's case is non-dismountable.
8. In the event of a failure, please refer to Appendix A before contacting technical support.
9. The manufacturer accepts applications under warranty and provides technical support only via e-mail or from authorized dealers.
10. The contact details of the manufacturer and a list of the authorized dealers are published on the website: <http://www.yachtd.com/>.

I. Product Specification

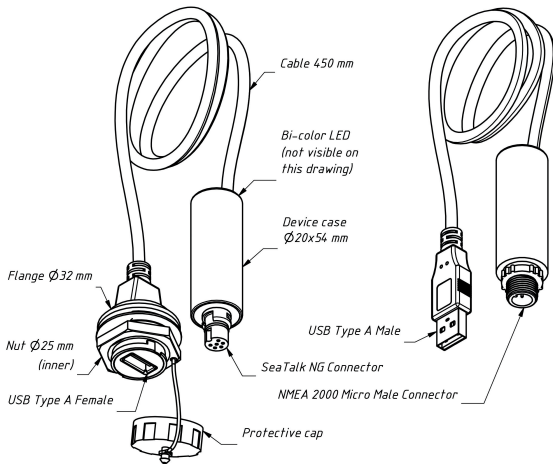

Figure 1. Drawing of YDNU-02RF and YDNU-02NM models of Gateway

Our devices are supplied with different types of NMEA 2000 connectors. Models containing R in the suffix of model name are equipped with NMEA 2000 connectors compatible with Raymarine SeaTalk NG. Models containing N in the suffix are equipped with NMEA 2000 Micro Male connectors. See connector drawings in Appendix B.



Gateways are equipped with high-quality USB Type A connectors with gold-plated contacts. Model containing M in the suffix of the model name are equipped with a male connector and must be used in dry place inside the cabin. These models are designed for direct connection to a PC USB port (not waterproof). Models with F in the suffix are equipped with a female connector with a protective cap and a 1/2 bayonet locking mechanism. It ensures a IP67 waterproof connection (see chapter II).

Device parameter	Value	Unit
Average current consumption from USB (see note 1)	35	mA
USB interface specification supported	1.1, 2.0, 3.0	—
USB Device VID / PID	0483 / A217	hex
USB connection waterproof rating (see note 2)	IP67	—
Supply voltage from NMEA 2000 network	7..16	V
Current consumption from NMEA 2000 network	13	mA
Load equivalency number	1	LEN
Galvanic isolation between NMEA 2000 and USB	2500	V _{RMS}
Cable length (between case and connector)	450	mm
Device case length	54	mm
Weight (models RM, NM / RF, NF)	37/51	g
Operating temperature range	-20..+55	°C

Note 1: The Device is powered from the USB port, the power supply from the NMEA 2000 network is used for the isolated part of the network transceiver only.

Note 2: For YDNU-02RF and YDNU-02NF models, use YU-USB cables (not supplied with the Device, see chapter II).

II. Installation of Device and Connection to NMEA 2000 Network

The Device requires no maintenance. When deciding where to install the Device, choose a dry mounting location. Avoid places where the Device can be flooded with water, as this can damage it.

The USB connector of YDNU-02RF and YDNU-02NF models may be mounted outside. In this case, using YU-USB2-CPI-01-100 or YU-USB3-CPI-01-100 cables ensures an IP67 waterproof connection. It is equipped with a protective cap used when no cable is connected (the connector is also compatible with general USB Type A cables). You can order these cables at our web site.

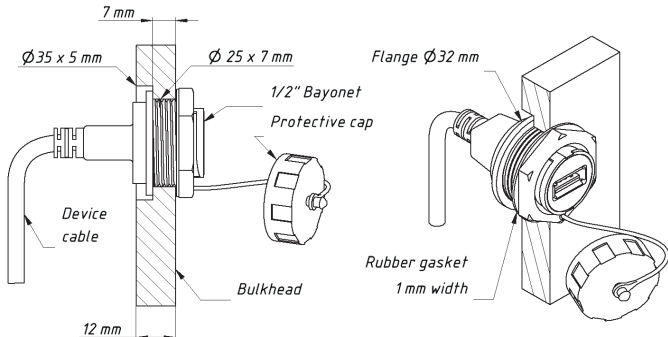

Figure 1. Mounting of YDNU-02RF and YDNU-02NF connectors on a bulkhead

When mounting on a bulkhead up to 7 mm, a hole only 25 mm in diameter is required to install the connector. In case of wider bulkheads, a groove of 33 mm diameter at least is required. The groove (and the hole) can be made with an inexpensive wood drill available world-wide (see Figure 2).

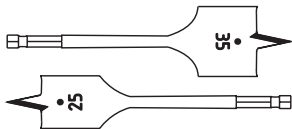

Figure 2. Inexpensive wood drill

YDNU-02RM and YDNU-02NM USB connectors must be used inside. These models are equipped with USB Type A Male connectors and designed for direct connection with a PC USB port (not waterproof).

The Device is directly connected to the NMEA 2000 network backbone without a drop cable. Before connecting the Device, turn off the bus power supply. Refer to the manufacturer's documentation if you have any questions regarding the use of connectors:

- SeaTalk NG Reference Manual (81300-1) for Raymarine networks
- Technical Reference for Garmin NMEA 2000 Products (190-00891-00) for Garmin networks

After connecting the Device, close the lock on the connection to ensure it is water resistant and firmly secured.

The Device is powered from USB, the power supply from the NMEA 2000 network is used for the isolated part of the network transceiver only. If you have no laptop or PC, you can power the Device with any USB power adapter (not supplied with a Device) for test purposes.

When the USB cable is plugged in, the Device LED will signal with one flash with a duration of one half second (see chapter IV for details) and the Device should appear in the list of NMEA 2000 (SeaTalk NG, SimNet, Furuno CAN) devices or in the common list of external devices on the chart plotter (see Figure 1. in chapter IX). Usually, access to this list is in the Diagnostics, External Interfaces or External devices menu of the chart plotter.



The Device allows sending of messages from PC applications to a NMEA 2000 network. Product misuse or PC software bugs can cause flooding of the marine network or sending of incorrect messages to the network and can lead to malfunction of critical ship systems. You must be sure that your software functions properly before a sea trial.

If you do not plan to control the marine systems from PC applications, it is recommended to block all outgoing PC application messages with YDNU SILENT ON command (please, see chapter V for details).

III. Installation of USB Drivers and Connection to PC

The Device is connecting to USB port of a PC and is compatible with USB 1.1 protocol (1998) and later. Therefore, it is compatible with all modern laptops and PCs. The Device is powered from the USB port and you will see LED signals after connection (otherwise it means that the cable or USB port is damaged).

At the software level, the Device is a serial port (Virtual COM Port; USB device class 2, subclass 2). Such devices do not require a special driver in Windows 10, Mac OS X and Linux; these operating systems automatically use a system driver. In older Microsoft Windows versions, you should install a driver (.INF file only, no code) which will tie the standard USBSER.SYS driver with a Device.



Serial ports are not intended for simultaneous use in multiple applications. If you can't open the Device's port in an application, it can mean that it is already opened in another one. This limitation can be avoided with 3-rd party software.



In Microsoft Windows you must set the COM port number below 10 (COM1..COM9) for Device. Otherwise, some applications will not be able to open the port and you will be unable to manage Device from command line (see chapter V). The COM port number may change each time when you plug in the USB device into a new USB port. When a USB device is plugged into the USB port where it was used previously, the operation system tries to assign the same COM port number.

Connect the Device to a PC USB port and wait while the operation system on the PC searches and installs a driver. The following sections contain important details about driver installation and Device configuration in: Microsoft Windows 10, previous Microsoft Windows versions (Windows 7, Windows 8 and Vista), Mac OS X, and Linux (Ubuntu).

Please read the section about your operation system carefully.

1. Microsoft Windows 10

Open «Device Manager» in the «Computer Management» applet of the Control Panel, and expand the «Ports (COM & LPT)» as shown in the picture below.

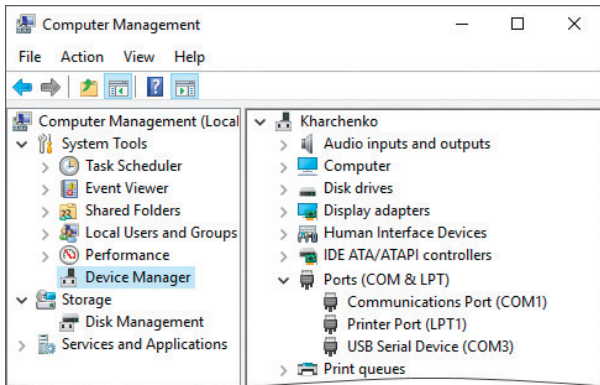

Figure 1. Windows 10 with a connected Device

You will see one or more USB serial devices. You can eject the USB cable to detect which one is NMEA 2000 USB Gateway.

Please remember the port number which was assigned automatically to the Device. If the port number is above COM9, you must change the port number to COM1 – COM9. Open the device's properties, switch to the «Port Settings» tab, and click the «Advanced...» button. Select another port number in the bottom left corner (see Figure 2). Usually you can ignore the «in use» mark near the port number, it means that this port was assigned to some other device previously; some computers have dozens of ports «in use» when actually there are no devices connected.

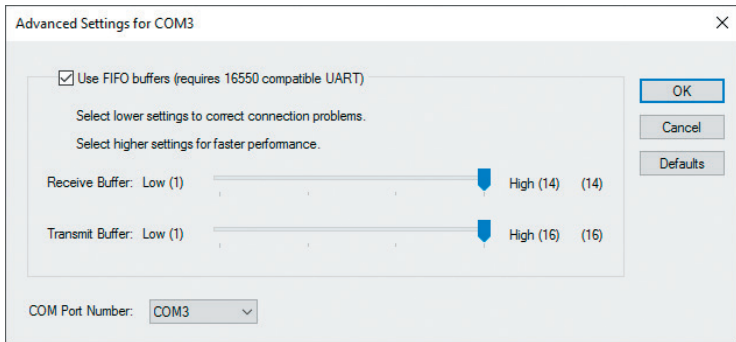

Figure 2. Advanced Settings of COM port

Port speed and related parameters have no practical effect on USB serial devices, so you can leave the defaults for these parameters.

After changing the COM port number, you need eject the Device from the USB port and insert it back. Until doing this, applications may fail to open the Device's port.

2. Other Microsoft Windows versions

Open the «Device Manager» in the «Computer Management» applet of the Control Panel. If the Device appears in the «Other devices» section after connection and has a yellow notification sign, then you need to install a driver. You need only the .INF file (no code installation is required) which will link the Device with the standard USBSER.SYS driver of Microsoft Windows.

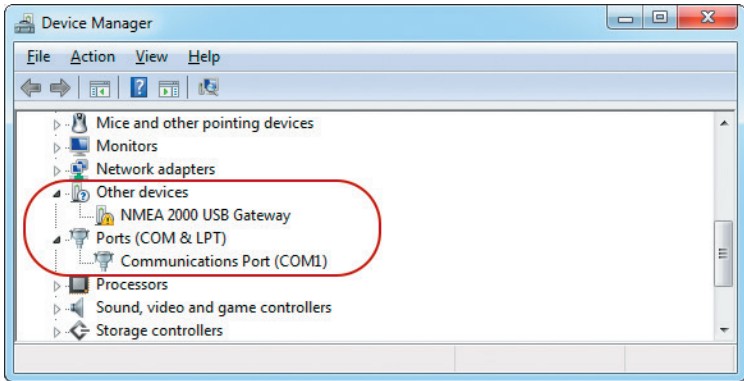

Figure 3. Windows 7 requires installation of driver

There are two options to get a driver for the Device:

- you can download a driver from our web site: <http://www.yachtd.com/downloads/USBDRV.zip>
- or you can download the Virtual COM Port driver from the STMicroelectronics web site <http://www.st.com> (type «STM32 Virtual COM Port Driver» in the search box on the site).

You should extract files from the ZIP archive to the disk folder.

Select «NMEA 2000 USB Gateway» and open the «Action \ Update Driver Software...» menu. Select «Browse my computer for driver software» and «Let me pick from a list of device drivers on my computer» in the opened window. Then select «Ports (COM & LPT)» as the device's type (see Figure 4).

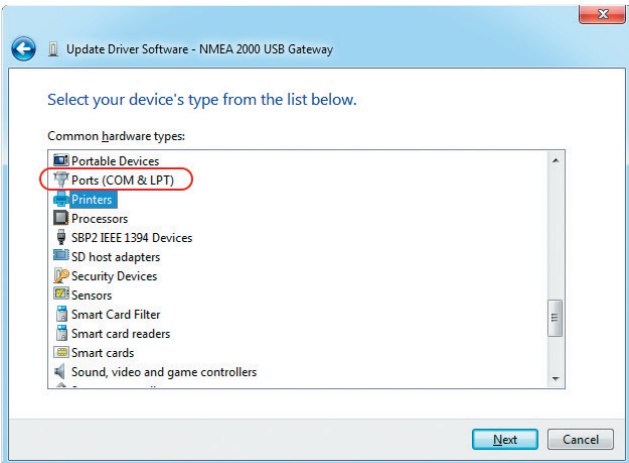

Figure 4. You should select «Ports (COM & LPT)»

When the device type is selected, you should select «STMicroelectronics» as the manufacturer (the manufacturer of the Device's core chip) and «STMicroelectronics Virtual COM Port» shown in Figure 5.

If you have no «STMicroelectronics Virtual COM Port» in the list, click the «Have Disk...» button and specify the folder with the previously extracted drivers (you should navigate to the subfolder

that corresponds to your operating system with a file named STMCDC.INF).

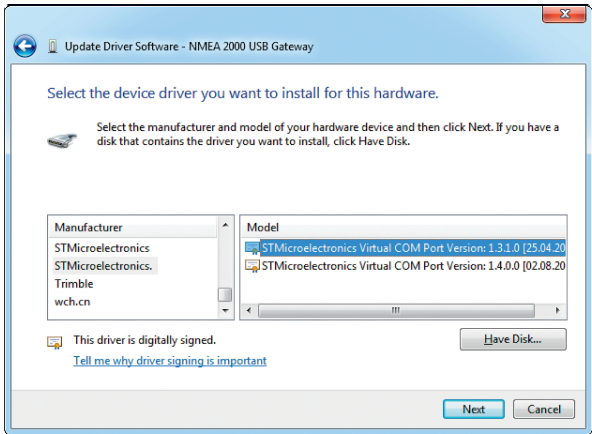

Figure 5. Driver selection

When the installation is done, please check an assigned COM port number. If the port number is greater than COM9, you must to change it (please see the «Microsoft Windows 10» section of this chapter).

3. Mac OS X

After connecting the Device, click on the Apple icon and select the «About This Mac» menu item. Click

the buttons «More Info...» and «System Report...» in the opened window. Locate «NMEA 2000 USB Gateway» in the USB subsection of Hardware section, as shown in Figure 6.

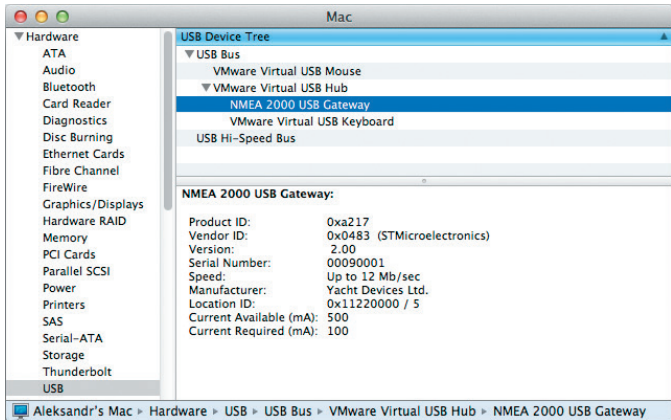

Figure 6. System Report on Mac OS X

This gateway has a serial number of 00090001, and the Device's port to use in applications is:

```
/dev/cu.usbmodem00090001
```

You can type the following command in the terminal to check the port name:

```
ls /dev/cu.usbm*
```

For a Device with serial number 00090001, the command's output will be:

```
/dev/cu.usbmodem00090001
```

4. Linux (Ubuntu)

The Device works with a system CDC ACM driver. After connection of the Device, type the following command in the terminal:

```
dmesg
```

The output's tail contains the Device's properties and port name:

```
[98.454005] usb 2-2.1: Product: NMEA 2000 USB Gateway
[98.454009] usb 2-2.1: Manufacturer: Yacht Devices Ltd.
[98.454013] usb 2-2.1: SerialNumber: 00090001
[98.461125] cdc_acm 2-2.1:1.0: ttyACM1: USB ACM device
```

The port name for use in applications is `/dev/ttyACM1` (printed in the last line of the output). You can type the following command in the terminal to check the port name:

```
ls /dev/ttyA*
```

Note that after connection, the modem manager can open a Device for a minute and the Device will not be available for use in other applications at this time. In this case, you can instruct the modem manager to ignore the Device using the USB identifiers of the product (VID and PID):

```
echo ATTRS{idVendor}==\«0483\» ATTRS{idProduct}==\«a217\»,
ENV{ID_MM_DEVICE_IGNORE}=\«1\» > /etc/udev/rules.d/ydnu.rules
sudo udevadm control -reload
```

IV. LED Signals

The Device is equipped with a bi-color LED that indicate the Device's state. Note, serial devices are intended for use by one application at a time and when the device is used in one application, you cannot use it in another application or send a command from the console (this is described in the next chapter) or update the firmware.

LED signals during a firmware update are described in chapter IX.

Table 1. Signals during a normal operation

LED Signal	Device State
One 0.5 second signal when USB cable is connected	Device is powered. RED signal indicates that «silent mode» is active and Device can send data to PC only, GREEN that Device in normal mode and can send data in both directions (see chapter V).
Two 0.5 second signals within a 3 second period	Device is connected to PC, port is not opened by an application. First signal is GREEN if data from NMEA 2000 are received during the period, RED otherwise. Second signal is GREEN if no data transmitted or received over USB, RED otherwise.
Four very rapid signals with a period of 1.5 second	Port is opened by an application. First signal is GREEN if data was received from NMEA 2000 during the period (otherwise RED). Second is GREEN if nothing was transmitted to NMEA 2000 by the Device during the period. Third is GREEN if data was transmitted to PC during the period. 4th is GREEN if no data was received from PC during the period.
Constant GREEN signal	Device can not send data to application more than 3 seconds (application hangs), but port is still opened by application. Connection with PC application detected by the state of DTR signal.
One-second GREEN signal	Operation mode command is received and accepted (see the next chapter for details).

LED Signal	Device State
Three RED signals per second for a 10 second period	Device is powered, but is not connected with a PC. It is possible that drivers are not installed or cable is damaged or Device is disabled («ejected») in PC settings or Device is connected to USB power adapter or with «power only» USB cable.
Three second GREEN signal	Recording of diagnostics data is turned on.
Three-second RED signal	Recording of diagnostics data is turned off (EEPROM buffer is full or service mode is turned on).

V. Configuration of Device Operation Modes

This section describes how to switch the output protocol (operation mode) of Device and how to switch it from bi-directional mode (factory setting, normal mode) to «read only» mode (silent mode).

The Device supports four operation modes: 0183, RAW, N2K and AUTO (see Introduction). The default operation mode is AUTO and we recommend keeping this setting. The technical aspects of AUTO mode functionality are available in chapter X.



Serial ports are not intended for simultaneous use in multiple applications. If you can't open Device's port in an application, it can mean that it is already opened in another one. This limitation can be avoided with 3-rd party software.

The change of the operation mode may be required for advanced users, for example, to view network messages in RAW format with terminal application.

To switch the mode, you should send a special command, «YDNU MODE», with a required mode name to the Device's serial port. You can do it with the built-in «echo» command in the command line (shell) in Microsoft Windows, Mac OS or Linux.



In Microsoft Windows, you must set the COM port number below 10 (COM1 – COM9) for Device (see III.1). Otherwise, you will be unable to manage the Device from a command line. The COM port number may change each time when you plug in a USB device into a new USB port.

For example, to switch operation mode to 0183, run the following command (all characters of Device command must be uppercase) in the command line (shell, command prompt) of the operation system:



```
echo YDNU MODE 0183 > COM3
```



```
echo YDNU MODE 0183 > /dev/cu.usbmodem00090001
```



```
stty -F /dev/ttyACM1 hupcl  
echo YDNU MODE 0183 > /dev/ttyACM1
```

Where:

- **echo** is a built-in command of an operating system;
- **YDNU MODE 0183** is a special command sent to the Device (turn on 0183 mode);
- **> (greater-than symbol)** is an operator that redirects command output.

We used the same port names (specified after the output redirection sign >) above, as were used in the examples of chapter III. The command will be confirmed by a one second green signal of the LED and the value set will be saved to the EEPROM.

The special command YDNU SILENT ON does not actually change the operation mode, but it prohibits sending of all outgoing messages from PC applications to the NMEA 2000 network, making the Device «read-only». We will call this the «silent mode» for simplicity.



```
echo YDNU SILENT ON > COM3
```



```
echo YDNU SILENT ON > /dev/cu.usbmodem00090001
```



```
stty -F /dev/ttyACM1 hupcl  
echo YDNU SILENT ON > /dev/ttyACM1
```



This setting is recommended if you are not planning to control the marine systems from PC applications. It protects the NMEA 2000 network from the threat of flooding caused by an incorrectly configured PC application. When the «silent mode» is on, the LED signal when the Device powers on is red, otherwise green (see chapter IV).

The command YDNU SILENT OFF returns the Device to the normal bi-directional mode. Both (on and off) commands are confirmed by a one second green signal of the LED and the setting will be saved to the EEPROM.

VI. Terminal Access to Service Menu

The Service menu allows you to change the Device's settings and view diagnostics data. Note that we recommend using the application's settings to filter NMEA messages instead of the Device settings, because Device settings have a global effect and sometime later you may be surprised that some things are not working in other applications.



To begin, you should put the Device in the service mode with the YDNU MODE SERVICE command from the operating system command line (shell). For example (please, see the explanation of command syntax in the previous chapter):

```
 echo YDNU MODE SERVICE > COM3  
 echo YDNU MODE SERVICE > /dev/cu.usbmodem00090001  
 stty -F /dev/ttyACM1 hupcl  
echo YDNU MODE SERVICE > /dev/ttyACM1
```

The command will be confirmed by a signal of Device's LED. Note that the service mode will be active until you set the operation mode or turn the Device off.

To access the service menu, you need a terminal application. Unlike Mac OS X and Linux, Microsoft Windows does not contain a terminal application (since Windows Vista). We recommend the freeware program, Putty, which is available for Microsoft Windows and Linux. You can download it here: <http://www.putty.org/>

When the Device is in the service mode, type the following command from command line or shell to access the service menu:

```
 putty.exe -serial COM3  
 screen -a /dev/cu.usbmodem00090001  
 screen -a /dev/ttyACM1  
stty -F /dev/ttyACM1 hupcl
```

If you are using Putty, you can also launch it without parameters, tick the «Serial» radio button and type the port name in the «Serial line», as shown in Figure 1. Leave all other settings unchanged.

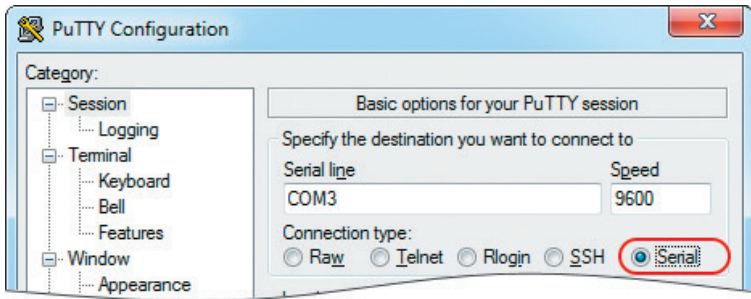

Figure 1. Putty is ready to open the COM3 serial port

After connection, you will see the welcome screen of service menu of Device (see Figure 2 on the next page).

If the welcome screen does not appear, make sure that the device is switched into the service mode and the right serial port name used for the connection.

```
gorlach — screen — 80x24
*****
*           Yacht Devices NMEA 2000 USB Gateway           *
*           S E R V I C E  M E N U                       *
*****
* Firmware version : 0.92 17/04/2017           NMEA 2000 silent : OFF *
* Serial number   : 00090001                 Previous mode   : AUTO   *
*****

Commands (any register is allowed):

mode [newmode] - Switch from service menu to the specified mode.
filter [name]  - Activates specified filter. Type HELP FILTER for details.
print [name]   - Print active filter or specified filter records.
add [...]     - Add records to active filter selected by FILTER command.
remove [...]  - Remove records from active filter (ALL to remove all).
type [newtype] - Switch filter's type to specified (WHITE or BLACK).
reset [what]  - Allows reset: MCU, SETTINGS, FILTERS, HARDWARE.
set [...]    - Set values for Device settings. Type HELP SET for details.
diag [what]  - Diagnostics records (ALL, USB_RX, N2K_TX...), Esc to break.
help [command] - Display help on command or this screen. Example: HELP MODE

Active filter : <not selected>

?>
```

Figure 2. Welcome screen of the service menu

VII. Service Menu Commands and Device Settings

The Service menu is like a command line of Windows and MS-DOS or Mac OS X or Linux shell. You should type commands (any register is allowed) and in case of a mistake, you can erase the last character with the Backspace button.

The welcome screen (see Figure 2 in the previous chapter) is displayed once after connection from the terminal application. To display the welcome screen again, type the HELP command and press the Enter button. To get help with a command, type HELP and the command for which you would like to see the help. For example, type HELP MODE and press Enter to get help for the MODE command.

1. MODE command and «exit» from service mode

The command MODE changes the operation mode of the Device. Four modes are available: 0183, N2K, RAW and AUTO (please see the Introduction chapter for details).

To «exit» from the service mode, you should activate some other operation mode with the MODE command. For example, after the command MODE 0183, you will see NMEA 0183 sentences in the terminal window:

```
?>MODE 0183
NOTE: 'Auto' mode (recommended) is turned OFF, because you manually switched
to another mode. Switching to '0183' mode, press Esc to switch back...
$--GGA,173412.00,4146.5882,N,07029.6988,W,2,13,0.80,0.00,M,0.00,M,0.00,0000*7F
$--GLL,4146.5894,N,07029.6952,W,173412.02,A*02
$--GSA,A,3,02,03,06,09,12,17,19,22,23,24,28,,0.7,0.7,0.4*2F
$--RMC,173412.00,A,4146.5882,N,07029.6988,W,6.9,62.9,280816,15.0,W,D,V*5F
$--ZDA,173412.04,28,08,2016,00,00*70
$--MWV,357.7,R,13.2,M,A*08
```

This means that 0183 mode is activated and you can close the terminal session. Or you can press the Esc button to return to the service menu.

You can also close the terminal program and set an operation mode from a command line, as described in chapter V. Note that service mode is active while the Device is powered, so you can unplug the USB cable

and plug it back in to return to the previous mode.

2. Filtering of messages (FILTER, PRINT, TYPE, ADD and REMOVE commands)

The Device has eight filter lists, which allows limiting the set of messages passed from the NMEA 2000 network to a PC application (incoming has RX suffix) and messages passed from the PC application to NMEA 2000 network (outgoing, has TX suffix):

- global_rx - Global filter for incoming NMEA 2000 messages transmitted to PC
- global_tx - Global filter for messages transmitted to NMEA 2000 network from PC
- raw_rx - For incoming messages transmitted to PC in RAW mode
- raw_tx - For messages received from PC in RAW mode
- n2k_rx - For messages transmitted to application in N2K mode
- n2k_tx - For messages received from application in N2K mode
- o183_rx - NMEA 0183 sentences passed to application in 0183 mode
- o183_tx - NMEA 0183 sentences accepted from application in 0183 mode

For operation with filter lists, you should be familiar with NMEA 2000 and NMEA 0183. Otherwise, we recommend not modifying any filters and using the filter setting in the PC application. In case of troubles with filters, you can reset the list of filters to the factory settings using the command RESET FILTERS or RESET SETTINGS, which resets all settings including filters.

To view or modify the filter, you should «activate» (select) it with the FILTER command first. For example:

```
FILTER GLOBAL_RX
```

The PRINT command without parameters prints records of the active filter. To view a non-active filter, specify its name after the command:

```
PRINT GLOBAL_TX
```

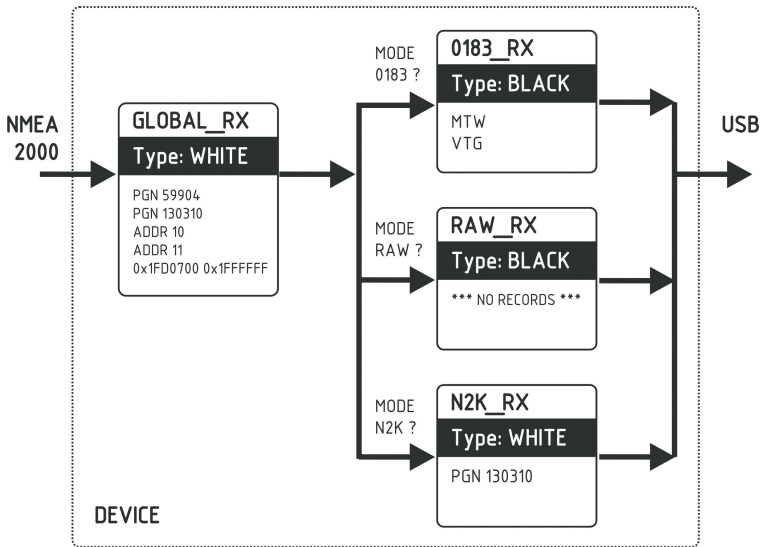

Figure 1. Example of configuration of incoming filters

Each filter list has a switchable type: WHITE or BLACK. A message is passed thru the WHITE filter if it contains a record matched with a message. And the reverse for BLACK. In the factory settings, all filter lists are empty and are of BLACK type, so all messages are passed through filters. To change the type of the active filter, use the TYPE command. For example:

```
TYPE WHITE
```

0183 filters contain 3-char NMEA 0183 sentence formatters. According the standard, a NMEA 0183 sentence start with a \$ or ! symbol, followed by two-character talker ID and 3-char sentence formatter. These elements are followed by data fields (after the comma). The sentence is finished by a check sum after the * (asterisk) symbol.

Gateway with factory settings using «YD» talker ID, it can be changed with SET command (see VII.4).

The Device uses 3-char sentence formatters only for filtering. The following sentences matches to GLL and VDM records (sentence formatters):

```
$GPGLL,4146.5894,N,07029.6952,W,173412.02,A*02  
!AIVDM,1,1,B,ENk`smq71h@@@@@@@@@@@@@@@@@=MeR6<7rpP00003vf400,4*5F
```

Other filters actually contain pairs of 29-bit message identifiers and a mask. The identifier is compared by processing the NMEA 2000 message identifier and the second value (mask) defines the comparison concerning which bits are significant.

The identifier contains a PGN (Parameter Group Number, described in NMEA 2000 Standard) and a source device address. PGN and ADDR keywords may be used to modify these lists more easy. You can use decimal and hexadecimal numbers (which start with a 0x prefix).

Multiple parameters may be passed to a command. The following examples add and remove all added records (note that right column syntax is differ):

```

FILTER GLOBAL_RX                FILTER 0183_TX
ADD PGN 130310 130311          ADD XDR GLL_VDO
REMOVE PGN 130310              REMOVE XDR
REMOVE 0x1FD0700 0x1FFFFF00    REMOVE GLL_VDO
ADD ADDR 0x10
REMOVE ADDR 16

```

When a PGN keyword is used (not applicable to 0183 filters), the Device adds or remove records with the mask 0x1FF0000 for addressed NMEA 2000 messages and 0x1FFFF00 for global-addressed messages. For example, to add the records listed in the GLOBAL_TX filter in Figure 1, you can enter the following commands:

```

FILTER GLOBAL_TX
ADD PGN 59904 130310
ADD ADDR 10 11
ADD 0x1fd0700 0x1ffffff

```

The actual content of the filter will be (type PRINT without parameters):

Message ID	Mask	Comment
0x00EA0000	0x01FF0000	PGN 59904
0x01FD0600	0x01FFFF00	PGN 130310
0x0000000A	0x000000FF	ADDR 0x0A (ADDR 10)
0x0000000B	0x000000FF	ADDR 0x0B (ADDR 11)
0x01FD0700	0x01FFFFFF	

To remove the third record from the list, you can type any of following commands:

```

REMOVE 0x0A 0xFF
REMOVE ADDR 0x0A
REMOVE ADDR 10

```

The command REMOVE ALL clears the current filter (removes all records) and switches its type to BLACK.

Let's check the processing of a message with PGN 130310 (Environmental Parameters) by filters in the configuration shown in Figure 1. It will be passed by the Global_Tx filter (filter type in Figure 1 is white). This message produces the sentences XDR and MTW in 0183 mode (see Appendix D, Table 1), so if this operation mode is active, we'll get the XDR sentence in the PC application, because the MTW sentence is blocked in 0183_Tx (type: black). In RAW or N2K mode, the 130310 message will be passed by the Raw_Tx and N2K_Tx filters.

The message with PGN 130314 (Actual Pressure) will pass the Global_Tx filter only if sent by a device with NMEA 2000 address 10 or 11. It passes the Raw_Tx filter in RAW mode (because filter in this configuration pass all messages), but will be blocked by the N2K_Tx filter in N2K mode (this filter passes 130310 messages only).

3. RESET command

This command accepts one argument:

- **RESET FILTERS.** Removes all records from all filters and switches types to **BLACK** (see previous section). This corresponds to the factory configuration of filters.
- **RESET SETTINGS.** This command resets all settings to factory values (including filters).
- **RESET HARDWARE.** EEPROM contains a copy of firmware file uploaded at the factory. After any firmware update, you can return to your initial firmware and return your Device to factory state. All settings are reset during this operation.
- **RESET MCU.** Reboot the Device.

4. SET command

The following settings can be set ON or OFF with this command:

- **SILENT** — silent mode, see Chapter V for details;
- **RAY_AUTOPILOT** — control of Raymarine autopilots from NMEA 0183;
- **WPT_CONFIRM** — automatic confirmation when changing the waypoint (works with Raymarine autopilots only);

- `RMB_N2K_VAR` — using of NMEA 2000 variation for RMB processing if an HDG or RMC sentences is not available;

To learn more about autopilot control, see the Chapter XI. Here is an example of how to turn on and off the silent mode, type:

```
SET SILENT ON
SET SILENT OFF
```

The `TALKER_ID` setting (see VII.2) accept two letters (AA..ZZ) or -- as argument, example:

```
SET TALKER_ID GP
```

After the command above, sentences sent by gateway will looks like `$GPGLL`.

The `WIND_CALC` setting is used to calculate the true wind. The wind sensor always measures apparent wind; true wind angle is calculated using `SOG` or `STW` data and true wind direction requires `COG` or heading. A chart plotter can join all these data and send calculated values to NMEA 2000, but usually `TWD`, `TWA` and `TWS` are not available.

Historically, `STW/HDG` are used to calculate true wind. However, this is not correct in places with strong current, and the «true» value of true wind can be obtained using the `SOG/HDG` pair. Therefore, our gateways offers four options: `SOG/HDG` (if you love truth), `SOG/COG` (if you have GPS only), `STW/HDG` (if tradition is most important), or you can disable calculations.

The `WIND_CALC` accepts the following arguments: `ANY` (factory setting), `HDG_STW`, `COG_SOG`, `HDG_STW` and `DISABLED`. In the last case the gateway reports true wind data only if they are calculated by another device available on NMEA 2000 network. The default setting «`ANY`» means that the gateway will detect what data are available on the network and will calculate true wind data using the best possible option.

To get the current value, type the command with the setting name only:

```
SET SILENT
```

The XDR sentence is used to transfer data from sensors, tanks, engines, etc. This sentence contains the sensor's text identifier (name), which was not defined by NMEA Standard until end of 2018. This led to the invention of names by every company on the market. For example, B&G uses "AIRTEMP" to send air temperature data, OpenCPN software uses "TempAir", Maretron uses "ENV_OUTSIDE_T", and the NMEA 0183 Standard 4.11 defines "Air".

Type the command

```
SET XDR
```

to list available settings for XDR sentence. With these settings you can define names used in XDR to provide compatibility with software or hardware. The length of the name is limited to 16 characters. An empty name means that data will not be sent in XDR sentence.

5. DIAG command

This command is used to display the record of diagnostic data (see next chapter for details). Due to the possibility of a large amount of data, the DIAG command requires at least one argument:

- ALL. Print all data (may take a minute or two, press Esc to brake).
- SETTINGS. Dump of settings copy, saved at beginning of recording.
- USB_RX. Data received from PC.
- USB_TX. Data transmitted to PC.
- N2K_RX. Data received from NMEA 2000 network (before filters).
- N2K_TX. Data actually transmitted to the network.

You can combine these arguments in any order, for example, to view all USB data:

```
DIAG USB_RX USB_TX
```

You can break the output at any moment by pressing the Esc button. Note that binary data (NMEA 2000 messages) are printed in hexadecimal, and text data (NMEA 0183 sentences) is printed as text.

Sample of data output:

00:00:47.812 USB TX \$--MWV,355.1,R,26.7,M,A*0F
\$--DBT,59.1,f,18.03,M,9.8,F*27
\$--MTW,22.9,C*1A
00:00:47.814 N2K RX DF80501 E0 2F FF 91 42 00 34 BA
00:00:47.815 N2K RX DF80501 E1 25 80 41 26 FB 85 38
00:00:47.816 N2K RX DF80501 E2 CC 05 80 D2 4E 58 3D
00:00:47.816 USB TX !AIVDM,1,1,,B,35NH9UP2h:Jv<8>GoHB5j0ah03j0,0*62
!AIVDM,1,1,,A,ENk`s1I13h@@@@@@@@@@@@@@@@=MlIV<8<dP00003vf000,4*42
00:00:47.816 N2K RX DF80501 E3 93 37 F6 6A 26 23 00
00:00:47.817 N2K RX DF80501 E4 00 00 00 00 10 FC 0B
00:00:47.818 N2K RX DF80501 E5 4E 00 69 00 3C F3 FF
00:00:47.819 N2K RX DF80501 E6 FF 00 FF FF FF FF
00:00:47.820 N2K RX 19FA0401 80 87 FF FF 0B 02 68 12

VIII. Recording of Diagnostics Data

With the command *YDNU DIAG* (sent in the same way as mode operation commands, see chapter V) you can start recording diagnostics data.



Serial ports are not intended for simultaneous use in multiple applications. You must close your marine application (or turn off the Device's port in the application settings) before sending the command to Device.

The Device confirms the command *YDNU DIAG* by a three-second green signal from the LED, saves a copy of current settings (including filters) to a diagnostic record, and after 3 seconds starts recording all data traffic on the NMEA 2000 and USB interfaces. Data are saved to the EEPROM buffer of 1 MB size. One second of recording usually takes 2 – 10 KB and the buffer is enough for 2-10 minutes of recording.

To stop recording, you can send a *YDNU MODE SERVICE* command. Recording also stops when free space in the EEPROM buffer is finished. The Device informs you with three-second red signal from the LED when stops recording.

Example of starting and stopping of recording in Microsoft Windows (please, see explanation of command syntax in the chapter V):

```
C:\>echo YDNU DIAG > COM3  
C:\>echo YDNU MODE SERVICE > COM3
```

Note that the buffer stores only one diagnostics record, and starting a new recording overwrites the previous diagnostics record.

To save the recorded diagnostics data to a file, you can print the diagnostics data with the *DIAG ALL* command in the service menu (see VII.5) with session logging turned on in your terminal application. All diagnostics data will be saved to a session log file.

In Mac OS X and Linux, you can turn on session logging with the `-L` key of the screen command:



```
screen -L /dev/cu.usbmodem00090001
```



```
screen -L /dev/ttyACM1
```

In Putty, (available for Microsoft Windows and Linux), select «Logging» in the Category tree in the «Putty configuration window» and tick the «All session output» radio button. Then choose output file location.

In the terminal session, run a DIAG ALL command and wait until all data is printed. Close the terminal program, locate the session log file (in Mac OS X and Linux the file will be located in the current folder and will have a name like «screenlog.0»). It may be big (2–3 MB) and we recommend packing it in a ZIP archive before sending by e-mail.

IX. Firmware Updates

You can check the current firmware version on the welcome screen of the service menu (see Figure 2 in chapter VI) or in Device information in the list of NMEA 2000 (SeaTalk NG, SimNet, Furuno CAN) devices or in the common list of external devices on the chart plotter (see third line in Figure 1). Usually, access to this list is located in the Diagnostics, External Interfaces or External devices menu of the chart plotter.

The screenshot shows the 'Select Device' screen in the Raymarine c125 MFD. The screen displays a table of connected devices with columns for Device, Serial No, Network, and Software. The 'Raymarine p70 Display' is highlighted in orange. The interface also includes a 'Diagnostics' menu at the top right and a bottom toolbar with icons for Standby, Radar, Tx, Sonar, and GPS Fix.

Device	Serial No	Network	Software
Digital Radome	E92129 0240451	SeaTalkHS	1.04
Raymarine p70 Display	0140299	STng	2.12
YDNU-02	00100023	STng	1.0 20/04/2017
i50 Tridata Instrument	0130213	STng	1.06
E22158-SeaTalk-STNG-Converter	1034742	STng	1.21
YDBC-05	00005027	STng	1.2 27/02/2015
Raymarine EV-1 Course Computer	0240651	STng	1.01 (RSCP V1 L4)

Figure 1. Raymarine c125 MFD devices list with Device (YDNU-02)

The firmware update leaves Device's settings intact. You will not damage the Device in the event of power failure or any other shutdown at any state of firmware update procedure.

To update Device firmware, you should copy the update file (with .BIN extension) to the Device's port:



```
copy /B UUPDATE.BIN COM3
```



```
cp UUPDATE.BIN /dev/cu.usbmodem00090001
```



```
cp UUPDATE.BIN /dev/ttyACM1
```

We used the same port names above, as were used in the examples in chapter III.

File uploading takes 3-10 seconds, during this time Device's LED will be off. The Device informs about upload result with the following LED signals (three fast flashes in one second):

- **Green, green, green.** File is successfully uploaded to Device's EEPROM.
- **Red, red, green.** Device already contains firmware of this version.
- **Red, green, red.** File header is correct, but uploaded file is corrupted.

If the Device produces no special signals after copying the file, it means that the file was not recognized by the Device as a firmware update file. This may be caused by copying a ZIP archive with firmware update instead of the firmware update BIN file.

After successful upload followed by three green signals, the Device reboots to pass control to the bootloader. The bootloader will make some additional checks, and if uploaded file is correct, the Device's LED will be turned off for 5-15 seconds, and a 10 second series of green and red flashes after that will indicate that firmware is updated. After that, the Device returns to a normal operation. If the file is incorrect, the bootloader returns control to the firmware program without any visual cues.

X. Programming Considerations

We welcome software developers who are interested in supporting Gateway protocols, and especially RAW mode protocol. We promise free technical support within reasonable limits and free testing of your products, even if you do not have a Device.

Table 1. Recommended mode activation sequences

Mode	Recommended activation sequence (hexadecimal)	Comments
0183	24 0A	Mode can be activated also by sending a valid NMEA 0183 sentence starting with '\$' (hexadecimal 24) or '!' (hexadecimal 21) symbols.
RAW	30 0A	Mode can be activated also by sending of valid message in RAW format. Or by any sequence starting with 'O..'9', 'a...'f or 'A..'F' characters. See appendix E for details.
N2K	10 02 A1 03 11 02 00 49 10 03	This sequence is used in the Canboat application to turn on «Receive All Messages» mode on ActiSense NGT. Any sequence starting with 10 02 bytes will activate N2K mode on the Device.

1. A copy of Appendix B of NMEA 2000 Standard must be purchased from the National Marine Electronics Association (www.nmea.org) to develop software which supports N2K or RAW mode.
2. The application must enable DTR signaling or manually set the DTR signal after opening the Device port and reset the DTR signal on close. In Microsoft Windows, this can be done with EscapeCommFunction and SetCommState API functions.
3. You should assume that the Device functions in AUTO operation mode, and you must not try to switch the mode with the YDNU MODE command without permission from the user if a mode that is non-compatible with your application is active.

4. The application must send a mode activation sentence (see Table 1) immediately after opening a port. Recommended sentences do not cause sending of any message to NMEA 2000 network. In the AUTO mode, the Device analyzes first bytes received from the application for the first 2000 milliseconds after the port is opened. If no data are received during that 2000 milliseconds, or received data cannot be interpreted as an activation sentence, the Device activates 0183 mode.
5. The application should avoid sending messages byte-by-byte. It is recommended to prepare a message (or even set of messages) in a memory buffer first and send it to the port with one call. Byte-by-byte calls can cause a series of one-byte USB packets that can have negative performance effect.

XI. Autopilot Control and Settings

This chapter describes how to control NMEA 2000 (SeaTalk NG) autopilot from the application using NMEA 0183 protocol.

Modern autopilots have the following modes:

- **Standby.** In this mode, autopilot is not engaged to the vessel control.
- **Auto.** The autopilot has a fixed course to steer.
- **Wind.** The autopilot steers the boat at a specified angle to the wind.
- **Waypoint.** The autopilot steers the boat to the specified waypoint.
- **Route or Track.** The autopilot steer the boat by a specified route.

The difference in the last two modes is that autopilot not only maintains the right direction to the waypoint, but also tries to follow the line from the previous to the next waypoint.

When NMEA 2000 autopilot is controlled from a NMEA 0183 application, it must receive:

- position of the destination waypoint (from RMB sentence);
- course from the position to the destination waypoint (APB and/or RMB);
- cross track error, means the distance and direction from the current position to the route (APB and/or RMB and/or XTE).

Depending on the implementation, the NMEA 2000 autopilot can also use the following data (and not only):

- vessel heading (HDG sentence), but in most systems the heading sensor is connected directly to the autopilot;
- rate of turn (ROT sentence);
- position, course and speed over ground (RMC sentence).

To control the autopilot, Gateway should receive APB and RMB sentences from the application. Gateway also needs to have magnetic variation data, which can be obtained from HDG or RMC sentences or from

the NMEA 2000 messages (must be turned on in the Gateway settings).

If your NMEA 2000 network has GPS data, it can use data already available on NMEA 2000 and sending of the ROT, HDG and RMC sentences from the application may not be required. It is better to send minimal data from a PC to the NMEA 2000 network if possible.

Depending on the autopilot sensitivity settings, autopilot can control your vessel smoothly or aggressively. The application only provides the situation (where is the waypoint and how far we are from the route), but the course to steer and the rudder angle are defined by the autopilot logic.

Switching of waypoints is the work of the application. If the arrival radius is set to 1 NM, application can switch to the next waypoint when the current point is still a mile away. If your route is circular or approximately so, the application can unexpectedly switch from the first point to the last. You should be familiar with your application settings and test how the system works on the open water.

The autopilot can warn you or ask for your confirmation when the application changing the waypoint. It depends on autopilot settings. When the application terminates the navigation, it usually stops sending APB and RMB sentences. Autopilot usually switches to Auto mode and signals about that.

Raymarine autopilots use proprietary messages to control. The Gateway was tested with the two systems, but we also expect that it will work well with all other Raymarine SeaTalk NG autopilots:

- Raymarine C90W chartplotter, Raymarine SPX SmartPilot SPX30 and Raymarine ST70 Pilot Head;
- Raymarine c125 chartplotter (LightHouse 17), Raymarine EV-1 Course Computer and Raymarine ACU200 Actuator Unit.

To control Raymarine autopilot:

- its support must be turned on in the settings (see VII.4), because it is turned off by default;
- autopilot must be initially set to the Auto mode to be controlled from the application;
- the application must provide APB, RMB and RMC sentences;
- the application should provide an HDG or RMC sentences or using of NMEA 2000 variation must be on in the settings (see VII.4).

When the route or waypoint is activating in the application, autopilot switches to the Track mode from Auto. If automatic confirmations are off (default settings, see VII.4), the chart plotter and pilot head will ask for the confirmation when waypoint is changing. When the application terminates the navigation, autopilot returns to the Auto mode.

It is impossible to switch from Track mode to Auto when the application controls the autopilot, because it will return it to the Track mode after a 5-second delay. To take control in an emergency, switch the autopilot to Standby mode.

APPENDIX A. Troubleshooting

Situation	Possible cause and correction
LED does not signal when USB cable is connected	USB cable or USB port is damaged. Replace the cable and/or try to connect Device to another port.
All Device signals are red with 10-second interval	Device is powered on, but is not connected with a PC (drivers are not installed; device is disabled in PC settings; etc.). If you connected the Device to a new USB port, re-connect it to the port used previously. Please see chapter IV Table 1 for details.
PC software does not work as expected	Record diagnostics data (see chapter VIII) and send it with a PC software screenshot to technical support.
Application cannot open Device port; write and/or access errors when sending commands to Device	Check the LED signals. If Device signals that the port is already opened by an application, close all applications that can use the Device port. In Linux, check the modem manager settings (see III.4). In Linux and Mac OS X, be sure that you have permissions on the Device port (see operation system manual).
Device does not accept operation mode commands	If the LED signals that port is already opened by an application, but you can open the Device's port with the terminal or any program, this may mean that there is incorrect handling of the DTR signal by the PC software. Try the following commands (replace the port name with your own) in operation mode command in Windows, Mac OS X, Linux: <ul style="list-style-type: none">• MODE COM3 DTR=ON• stty -F /dev/cu.usbmodem00090001 hupcl• stty -F /dev/ttyACM1 hupcl

APPENDIX B. Device Connectors

V+, V- – Battery 12V; CAN H, CAN L – NMEA 2000 data;
SCREEN – Not connected in the Device.

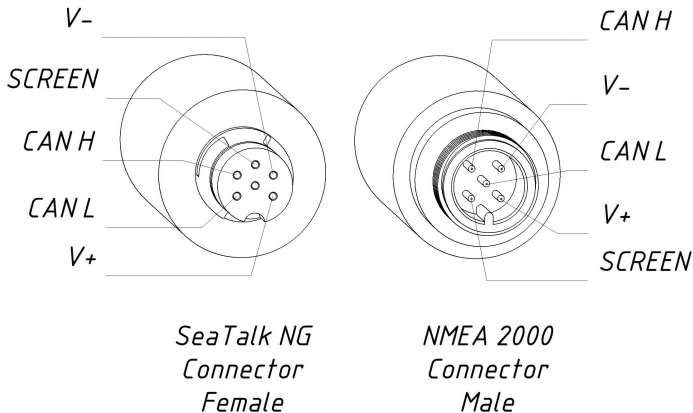

Figure 1. NMEA 2000 connectors of the YDNU-02RM and YDNU-02RF (left), and connectors of the YDNU-02NM and YDNU-02NF (right) models

APPENDIX C. NMEA 2000 Messages Supported by Device

The Gateway can pass any message from NMEA 2000 to a PC application and in the opposite direction. «No» in the table below means that the Device will not process these messages during service communication with other devices on the network. Note that service communications are not affected by the «silent mode» of the Device (see chapter V).

Appendix D contains the list of messages processed during conversion from NMEA 2000 to NMEA 0183 and from NMEA 0183 to NMEA 2000.

Table 1. Messages supported by Device

Message	Receive	Transmit
ISO Acknowledgment, PGN 59392 (0xE800)	Yes	Yes
ISO Address Claim, PGN 60928 (0xEE00)	Yes	Yes
ISO Commanded Address, PGN 65240 (0xFED8)	Yes	No
ISO Transport Protocol (CM), PGN 60416 (0xEC00)	Yes	No
ISO Transport Protocol (DT), PGN 60160 (0xEB00)	Yes	No
ISO Request, PGN 59904 (0xEA00)	Yes	No
GNSS Position Data, PGN 129029 (0x1F805)	Yes	No
Local Time Offset, PGN 129033 (0x1F809)	Yes	No
NMEA Group Function, PGN 126208 (0xED00)	Yes	No
PGN List Group Function, PGN 126464 (0x1EE00)	No	Yes
Product Information, PGN 126996 (0x1F014)	Yes	Yes
System Time, PGN 126992 (0x1F010)	Yes	No

APPENDIX D. Conversions Between NMEA 2000 and NMEA 0183

Table 1. Conversions from NMEA 2000 to NMEA 0183

NMEA 2000 PGN	NMEA 0183 Sentence	Comment
65311 Magnetic Variation (Raymarine Proprietary)	—	See note (4)
126992 System Time	ZDA, GLL	See also PGN 129033
127233 Man Overboard Notification (MOB)	MOB	
127237 Heading/Track Control	APB, HSC	Use PGN 129284, 129283 if possible
127245 Rudder	RSA	Two rudders supported
127250 Vessel Heading	HDG, HDM, HDT	See note (4)
127251 Rate of Turn	ROT	
127258 Magnetic Variation	—	See note (4)
127488 Engine Parameters, Rapid Update	RPM, XDR, DIN, PGN	See note (6)
127489 Engine Parameters, Dynamic	XDR, DIN	See note (6)
127493 Transmission Parameters, Dynamic	DIN, PGN	See note (6)
127501 Binary Status Report	DIN	See note (6)
127505 Fluid Level	DIN, PGN	See note (6)
127508 Battery Status	DIN, PGN	See note (6)
128259 Speed, Water referenced	VHW	Also may be used in RMC, VTG
128267 Water Depth	DBT, DBS, DPT	

Table 1 continued

NMEA 2000 PGN	NMEA 0183 Sentence	Comment
128275 Distance Log	VLW	
129025 Position, Rapid Update	GLL	Also use PGN 126992 or 129029
129026 COG & SOG, Rapid Update	VTG	Also used in RMC
129029 GNSS Position Data	GGA, GLL, RMC, ZDA	See also PGN 129033
129033 Local Time Offset	—	Time offset is used in ZDA
129044 Datum	DTM	
129283 Cross Track Error	XTE	
129284 Navigation Data	RMB, HSC	Use 129283, 129029 if possible
129285 Navigation — Route/WP information	—	Waypoint names from this message are used in RMB and APB sentences
129291 Set & Drift, Rapid Update	VDR	
129539 GNSS DOPs	GSA	PGN 129540 is also required
129540 GNSS Sats in View	GSV, GRS	PGN 129539, 129029 required
130066 Route and WP Service — Route/WP— List Attributes	RTE	Use waypoints from 130067
130067 Route and WP Service — Route — WP Name & Position	WPL	
130074 Route and WP Service — WP List — WP Name & Position	WPL	

Table 1 continued

NMEA 2000 PGN	NMEA 0183 Sentence	Comment
130306 Wind Data	MWD, MWV, VWR, VWT	See note (3). Also used in MDA.
130310 Environmental Parameters	XDR, MTW, MDA	See note (1), (5)
130311 Environmental Parameters	XDR, MTW, MDA	See notes (1), (2), (5)
130312 Temperature	XDR, MTW, MDA	See notes (1), (2), (5)
130313 Humidity	XDR, MDA	See notes (1), (2), (5)
130314 Actual Pressure	XDR, MDA	See notes (1), (2), (5)
130316 Temperature, Extended Range	XDR, MTW, MDA	See notes (1), (2), (5)
130578 Vessel Speed Components	VBW	
129038 AIS Class A Position Report	VDM, VDO	AIS VHF messages 1, 2 and 3
129039 AIS Class B Position Report	VDM, VDO	AIS VHF message 18
129040 AIS Class B Extended Position Report	VDM, VDO	AIS VHF message 19
129041 AIS Aids to Navigation (AtoN) Report	VDM, VDO	AIS VHF message 21
129793 AIS UTC and Date Report	VDM, VDO	AIS VHF messages 4 and 11
129794 AIS Class A Static and Voyage Related Data	VDM, VDO	AIS VHF message 5
129798 AIS SAR Aircraft Position Report	VDM, VDO	AIS VHF message 9
129802 AIS Safety Related Broadcast Message	VDO, VDM	AIS VHF Message 14
129809 AIS Class B «CS» Static Data Report, Part A	VDM, VDO	AIS VHF message 24

Table 1 continued

NMEA 2000 PGN	NMEA 0183 Sentence	Comment
129810 AIS Class B «CS» Static Data Report, Part B	VDM, VDO	AIS VHF message 24

Note (1): Air, dew point, inside (saloon), water and exhaust gas temperature, inside and outside humidity, barometric pressure are supported.

Note (2): Only messages with data instance 0 are converted.

Note (3): Device with factory settings perform conversion from true to apparent wind and vice versa. MWV sentence is sending twice (one for relative wind and one for true). See VII.4 (SET command) for details.

Note (4): Magnetic variation is used in RMC, HDT, HDG, VDR, VHWP, VTG. Priority of variation PGNs: 127250, 127258, 65311.

Note (5): MDA is sent only when air, dew point or water temperature, or barometric pressure or outside humidity are available. Also contains wind speed and direction.

Note (6): DIN and PGN are wrap NMEA 2000 messages according SeaSmart (v1.6.0) and MiniPlex (v2.0) specifications. Engine revolutions, boost pressure, coolant temperature, hours, fuel rate, alternator voltage are also transmitted in XDR sentence.

Table 2. Conversions from NMEA 0183 to NMEA 2000

NMEA 0183 Sentence	NMEA 2000 PGN	Comment
APB	129283 Cross Track Error	Also used in PGN 129284
DPT	128267 Water Depth	
DIN	59904 ISO Request 127488 Engine Parameters, Rapid Update 127489 Engine Parameters, Dynamic 127493 Transmission Parameters, Dynamic 127502 Switch Bank Control 127505 Fluid Level 127508 Battery Status	According SeaSmart.Net protocol specification v1.6.0
DTM	129044 Datum	
GGA	129029 GNSS Position Data	ZDA or RMC are required
GLL	129025 Position, Rapid Update	See note (7)
GSA	129539 GNSS DOPs	
GSV	129540 GNSS Sats in View	Use data from GRS and GSA
HDG	127250 Vessel Heading	
HDM, HDT	127250 Vessel Heading	Use variation and deviation from HDG
MDA	130311 Environmental Parameters 130314 Actual Pressure 130306 Wind Data	Relative air humidity, air and water temperature, atmospheric pressure, wind data
MOB	127233 Man Overboard Notification (MOB)	

Table 2 continued

NMEA 0183 Sentence	NMEA 2000 PGN	Comment
MTW	130311 Environmental Parameters	
MWD	130306 Wind Data	
MWV	130306 Wind Data	Theoretical wind sent as calculated using Heading/Speed through Water
RMB	129283 Cross Track Error 129284 Navigation Data 129285 Navigation – Route/WP information	Use data from APB; PGN 129284 sent twice with true and magnetic bearings
RMC	126992 System Time 127258 Magnetic Variation 129025 Position, Rapid Update 129026 COG & SOG, Rapid Update	See note (7)
RSA	127245 Rudder	
RTE	130066 Route and WP Service – Route/WP-List Attributes 130067 Route and WP Service – Route – WP Name & Position	Use data from WPL
ROT	127251 Rate of Turn	
VBW	130578 Vessel Speed Components	
VDR	129291 Set & Drift, Rapid Update	
VHW	128259 Speed, Water referenced	
VLW	128275 Distance Log	
VTG	129026 COG & SOG, Rapid Update	

NMEA 0183 Sentence	NMEA 2000 PGN	Comment
VWR, VWT	130306 Wind Data	
WPL	130074 Route and WP Service — WP List — WP Name & Position	Only waypoints not included to the route (the RTE should be received during 3 seconds after WPL).
XTE	129283 Cross Track Error	
ZDA	126992 System Time 129033 Local Time Offset	
VDO, VDM	129038 AIS Class A Position Report 129039 AIS Class B Position Report 129040 AIS Class B Extended Position Report 129041 AIS Aids to Navigation (AtoN) Report 129793 AIS UTC and Date Report 129794 AIS Class A Static and Voyage Related Data 129798 AIS SAR Aircraft Position Report 129802 AIS Safety Related Broadcast Message 129809 AIS Class B «CS» Static Data Report, Part A 129810 AIS Class B «CS» Static Data Report, Part B	AIS VHF messages 1, 2 and 3 AIS VHF message 18 AIS VHF message 19 AIS VHF message 21 AIS VHF messages 4 and 11 AIS VHF message 5 AIS VHF message 9 AIS VHF Message 14 AIS VHF message 24 AIS VHF message 24

Note (7): The Device provides 50 milliseconds intervals between outgoing NMEA 2000 messages that are generated by more than one NMEA 0183 sentence. For example, a message with PGN 129025 is generated only once if RMC and GLL are received within a 50 millisecond interval, and twice if the time between GLL and RMC is more than 50 milliseconds.

Note (8): Sentences with no significant data (or data marked as invalid) may not be translated to NMEA 2000 messages. NMEA 0183 sentences with invalid check sum are ignored.

APPENDIX E. Format of Messages in RAW Mode

In RAW mode, network messages are converted to plain text format. We recommend that software developers support this format in applications because it is the easiest option. In the terminal window, NMEA 2000 messages look like a log in a chart plotter.

Messages sent from Device to PC have the following form:

```
hh:mm:ss.ddd D msgid b0 b1 b2 b3 b4 b5 b6 b7<CR><LF>
```

where:

- **hh:mm:sss.ddd** — time of message transmission or reception, ddd are milliseconds;
- **D** — direction of the message ('R' — from NMEA 2000 to PC, 'T' — from PC to NMEA 2000);
- **msgid** — 29-bit message identifier in hexadecimal format (contains NMEA 2000 PGN and other fields);
- **bo..b7** — message data bytes (from 1 to 8) in hexadecimal format;
- **<CR><LF>** — end of line symbols (carriage return and line feed, decimal 13 and 10).

Example:

```
17:33:21.107 R 19F51323 01 2F 30 70 00 2F 30 70
17:33:21.108 R 19F51323 02 00
17:33:21.141 R 09F80115 A0 7D E6 18 C0 05 FB D5
17:33:21.179 R 09FD0205 64 1E 01 C8 F1 FA FF FF
17:33:21.189 R 1DEFFF00 A0 0B E5 98 F1 08 02 02
17:33:21.190 R 1DEFFF00 A1 00 DF 83 00 00
17:33:21.219 R 15FD0734 FF 02 2B 75 A9 1A FF FF
```

Time of message is UTC time if the Device has received the time from the NMEA 2000 network, otherwise it is the time from Device start.

The format of messages sent from application to Device is the same, but without time and direction field.

Outgoing messages must end with <CR><LF>. If the message from application is accepted, passes filters and is transmitted to NMEA 2000, it will be sent back to the application with ‘T’ direction.

For example, the application sends the following sentence to the Device:

```
19F51323 01 02<CR><LF>
```

When this message is sent to the NMEA 2000 network, the Application receives an answer like:

```
17:33:21.108 T 19F51323 01 02<CR><LF>
```

The Application will get no answer if the message filtered or the message syntax is invalid.

The format of NMEA 2000 messages is available in Appendix B of NMEA 2000 Standard, which can be purchased on the site www.nmea.org.

APPENDIX F. Format of Messages in N2K Mode

In N2K mode, messages are encoded in a binary format. This format is based on Data Link Escape encoding partially compatible with ActiSense NGT format and widely support by modern marine applications. This format is very similar to Garmin Serial Protocol (see section 3.1 of Garmin Device Interface Specification 001-00063-00 for details).

All data are transferred in byte-oriented packets. A packet contains a four-byte header (DLE, STX, ID, and Size), followed by a variable number of data bytes, followed by a three-byte trailer (Checksum, DLE, and ETX). The following table shows the format of a packet:

Table 1. Packet format

Byte Number	Byte Description	Note
0	Data Link Escape	ASCII DLE character (16 decimal)
1	Start of Text	ASCII STX character (02 decimal)
2	Packet ID	Identifies the type of packet
3	Size of Packet Data	Number of bytes of packet data (bytes 4 to n-4)
4 to n-4	Packet Data	0 to 255 bytes, see Table 2
n-3	Checksum	2's complement of the sum of all bytes from byte 1 to byte n-4
n-2	Data Link Escape	ASCII DLE character (16 decimal)
n-1	End of Text	ASCII ETX character (03 decimal)

If any byte in the Size, Packet Data, or Checksum fields is equal to DLE, then a second DLE is inserted immediately following the byte. This extra DLE is not included in the size or checksum calculation. This procedure allows the DLE character to be used to delimit the boundaries of a packet.

Packets with NMEA 2000 messages transmitted to the PC application (incoming) have ID 0x93 (147 decimal), packets with NMEA 2000 messages sent by the application to the Device (outgoing) have ID 0x94 (148 decimal).

Table 2. Packet data format

Byte Number	Byte Description	Note
0	Message Priority	Bits 0 - 2 are significant, other bits are ignored
1 to 3	NMEA 2000 PGN	Least significant byte is first
4	Destination Address	Or 255 decimal for global addressed messages
5	Source Address	Ignored for outgoing messages, Device address is used
6–9	Time Stamp	Device's time in milliseconds, ignored in outgoing messages
10	Size of Payload	Number of bytes in NMEA 2000 message payload (1..232)
11+	Message Payload	1 to 232 bytes of message payload

The format of NMEA 2000 messages is available in Appendix B of NMEA 2000 Standard, which can be purchased on the site www.nmea.org.

