



GR350BT

MARINE STEREO AND MULTIMEDIA ENTERTAINMENT SYSTEM



USER MANUAL

CONTENTS

| | |
|---|-----------|
| Introduction | 4 |
| Key Features | 4 |
| What's in the Box | 4 |
| Optional Accessories | 5 |
| Compliance | 5 |
| FCC Part 15 Compliance | 5 |
| Listening to FM in Your Marine Vehicle | 6 |
| Installation | 6 |
| Installation Precautions | 6 |
| Choosing a Location for your radio | 7 |
| Mounting the Radio | 8 |
| Electrical wiring and connections | 9 |
| Wiring Connections | 9 |
| DC Connections | 10 |
| Hi/Low DC Supply Voltage Warnings | 11 |
| Antenna Installation | 13 |
| Controls | 14 |
| General Operation | 15 |
| Power On/Off | 15 |
| Main Menu | 15 |
| Settings Submenu | 16 |
| Input Source Selection | 19 |
| Backlighting | 19 |
| Adjusting the Sound | 20 |

| | |
|---|-----------|
| AM/FM Receiver Operation | 23 |
| Tuning for Stations | 24 |
| Local Mode | 27 |
| Stereo/Mono Selection | 28 |
| Bluetooth® Operation | 30 |
| Playing and Viewing USB Media | 33 |
| Viewing Movie Files | 38 |
| Viewing Photo Files | 41 |
| Auxiliary Input Operation | 44 |
| Playing music through the auxiliary input | 44 |
| Specifications* | 45 |
| General | 45 |
| FM Broadcast Receiver | 45 |
| AM Broadcast Receiver | 46 |
| Audio Amplifier | 46 |
| Bluetooth | 47 |
| USB Playback | 47 |
| Environmental | 47 |
| External Connectors | 47 |
| Multimedia support | 48 |
| Audio | 48 |
| Video | 48 |
| Photo | 49 |
| Trouble-Shooting | 49 |

INTRODUCTION

Congratulations on purchasing your compact GME GR350BT series marine stereo and multimedia entertainment system.

The GR350BT is a state-of-the-art Marine Entertainment System combining an AM/FM Radio with Bluetooth® audio streaming that can be paired with any smartphone, tablet or compatible device. An auxiliary input socket allows direct audio connection to generic MP3/WMA media players that do not support Bluetooth streaming.

The GR350BT Marine Multimedia Entertainment System has been developed utilising a combination of the very latest in digital electronic technology, and the design expertise gained by GME engineers over several decades of marine product development. The design and engineering of the radio ensures that your radio is protected against any harsh marine environment and ensures many years of reliable service.

KEY FEATURES

- Bluetooth streaming
- USB/AUX inputs
- Built-in AM/FM tuner
- 4 X 40W Speaker Outputs
- Full-color 2.7" TFT LCD Display
- Water-resistant

WHAT'S IN THE BOX

- GR350BT AM/FM Marine stereo
- Mounting hardware
- Mounting template
- DC power lead
- Speaker leads
- Quick start guide

- Ingress protection to IPX5 (excludes external connectors)
- Conformally coated PCB's for the harsh marine environment.
- UV Stabilized Plastics
- Available in black or white.

OPTIONAL ACCESSORIES

- Range of GME Speakers
- Range of GME Marine AM /FM Antennas
- Auxiliary input interface cable - LE74

COMPLIANCE

This device complies with AS/NSZ 61000.6.3:2007

FCC PART 15 COMPLIANCE

This equipment has been tested and found to comply with the limits for a Class B digital device, pursuant to part 15 of the FCC Rules. These limits are designed to provide reasonable protection against harmful interference in a residential installation. This equipment generates and can radiate radio frequency energy and if not installed and used in accordance with the instructions, may cause harmful interference to radio communications.

However, there is no guarantee that interference will not occur in a particular installation. If this equipment does cause harmful interference to radio or television reception, which can be determined by turning the equipment off and on, the user is encouraged to try to correct the interference by one or more of the following measures:

- Reorient or relocate the receiving antenna.
- Increase the separation between the equipment and receiver.
- Connect the equipment into an outlet on a circuit different from that to which the receiver is connected.
- Consult the dealer or an experienced radio/TV technician for help.

LISTENING TO FM IN YOUR MARINE VEHICLE

The majority of FM broadcasts are music programs. Compared with AM signals, FM signals have a wider dynamic range, are relatively immune to noise and provide distortion-free reproduction.

FM programs are broadcast for local reception and may not be heard satisfactorily at distant locations. To enjoy FM programs at their best, it is important that you tune to a station that is broadcasting in your locality.

FM signals can reflect from solid objects such as buildings or hills. If these reflected signals are received along with signals that are arriving directly from the transmitter, they may mix together to produce what is known as 'multipath distortion'. This distortion is heard as noise. Often, moving as little as 1 meter from your position will correct this problem.

FM signals travel in straight lines. However, because the signals are reflected from or absorbed by large solid objects, a signal 'shadow' may be present behind the object which may result in poor reception in that area.

INSTALLATION

INSTALLATION PRECAUTIONS

- If you are connecting your GR350BT radio for the first time, or have just reconnected your boat battery and you are experiencing problems with the unit's operation, we recommend you reset the unit. The reset function is accessed through the Main MENU SETTINGS option See PAGE X for details.
- The pre-set station memories and clock time are retained only while the power lead is connected to the Vessels DC power source. If the Power lead is disconnected or switched off at the master switch or the unit is removed from the vessel, the station memories will be lost, and the clock will need to be reset.

CHOOSING A LOCATION FOR YOUR RADIO

The GR350BT is designed for in-dash mounting in an accessible position near your vessel's steering position. Keep the following points in mind when choosing a location:

- Minimise excessive exposure to continuous rain or spray.
- Minimise exposure to excessive vibration or continuous direct sunlight.
- Allow room behind the radio to run the DC Lead to the power source.
- Allow a free flow of air around the heat sink on the back of the radio.
- To avoid interference to compasses, ships autopilot sensors etc, the GR350BT radio should be mounted at least 300 mm away from such devices.

The GR350BT multimedia hub can be mounted nearby or installed in a separate location inside the cabin using an extension lead. The cover on the multimedia hub should remain accessible to allow access for connecting your MP3 music source USB memory stick, or generic MP3 player.

MOUNTING THE RADIO

When mounting your radio using the mounting plate, please refer to the diagram below.

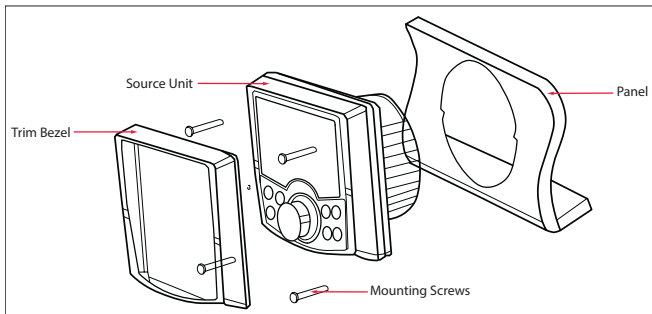

Select a suitable mounting location then examine behind the panel to determine that there is sufficient access for routing the cables and fitting the mounting screws. For panels of 6 – 9 mm thickness such as aluminum, plywood or fiberglass, the unit can be mounted using the 12 mm screws supplied (refer the diagram above).

1. Cut out a circular hole 77mm (3 inches) in diameter on your mounting location. Keep in mind that at least 95mm (3.75 inch) depth is needed to mount the radio.
IMPORTANT: Do not mount this unit where it can be submerged in water.
2. Use the supplied mounting template to mark and drill holes for the four mounting screws.
3. Slide the mounting plate over the backside of the unit and secure with the supplied screws.
4. Press on the Trim Bezel to the front side of the unit.
5. Plug in all wiring harnesses and cables. Refer the wiring diagram in this guide.

ELECTRICAL WIRING AND CONNECTIONS

When connecting the GR350BT to your vessels electrical system, please refer to the wiring and rear connections diagrams in the following sections.



CAUTION: The GR350BT is designed for vessels with a 12 Volt DC negative (-) ground (earth) electrical system only! Reverse polarity or over-voltage connection will result in internal damage to your unit, voiding the warranty and requiring servicing by qualified personnel.

WIRING CONNECTIONS

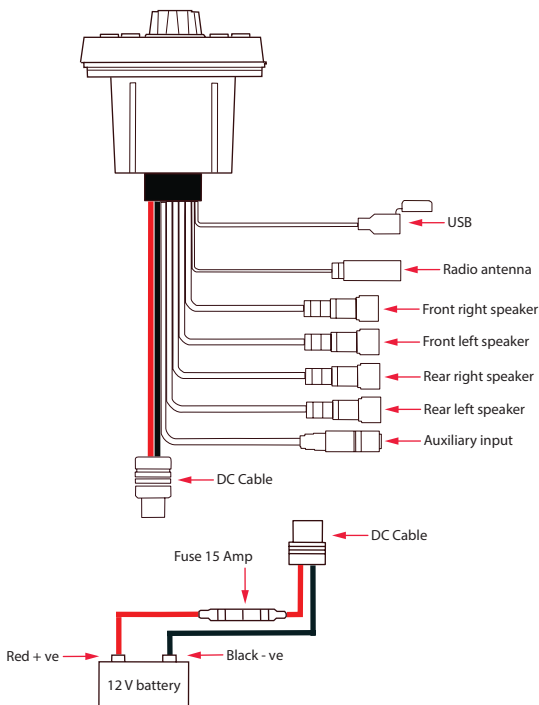

DC CONNECTIONS

Please refer to the wiring diagram in the previous section.

1. Connect the RED power lead to the positive (+) side of the battery or to an accessory point in the vessel or vehicle's fuse box that provides a +12 Volt DC connection.
2. Connect the BLACK power lead to the negative (-) side of the battery or to a ground point in your vessel or vehicle.

IMPORTANT NOTES:

- The RED power lead is fitted with a 15 amp fuse. If the fuse blows, use only a standard 15 amp (3AG) fuse as a replacement. Use of a higher rated fuse or a slow-blow type could result in damage to your radio which would void the warranty. If the fuse blows a second time, please contact your GME dealer for advice.
- Your GR350BT radio is able to maintain its memories and clock time when it is switched off by drawing power directly from your battery via the RED Lead. Although the memory backup current is very small (about 10 mA), it could eventually discharge your battery if left connected indefinitely. The time taken to completely discharge your battery could vary depending on its amp-hour rating and battery condition.
- If you do not run your boat's motor regularly or your battery is not kept charged between outings (e.g. solar or wind charger), we recommend you disconnect the RED lead each time you secure or trail your boat. This is easily done by connecting the lead via a master switch, which can be switched off after each outing. This will mean you will lose all your pre-set station memories and clock settings.

HI/LOW DC SUPPLY VOLTAGE WARNINGS

In the cases where the supply voltage EXCEEDS 18.0 Volts or FALLS Below 7.0 VOLTS the GR350BT displays the following warnings:



If either of these appear, it indicates a problem with your power supply. Please switch the radio off and check your vessels electrical system.

SPEAKER CONNECTIONS

This section details the ideal way to connect speakers to your GR350BT radio:

- Connect the speakers to the respective FRONT (LEFT/RIGHT) and REAR (LEFT/RIGHT) speaker fly-leaded sockets at the back of the unit.
Note that the speaker sockets are fitted with protective covers to protect against water ingress when not in use.
- The GR350BT radio is supplied with four 3.5 mm speaker adapter leads which are designed to accept the standard bullet connectors commonly found on most marine and automotive stereo speaker cables. The plugs on the speaker adapters plug into the matching sockets on the speaker fly-leads attached to rear of the radio. The speaker adapters are labeled and should be matched with the labels on the speaker socket fly-leads to ensure correct speaker phasing. Incorrect polarity (speaker phasing) will result in a significant reduction of bass response and stereo effect.
- When connecting the speakers, observe the correct speaker polarity by matching the white stripes on the speaker leads with the white stripes on the adaptor cable as shown in the connections diagram that follows. Incorrect polarity (speaker phasing) will result in a significant reduction of bass response and stereo effect.

- Connect all four speakers as shown in the connection diagram that follows.
- Adjust the BALANCE and FADER controls for the required LEFT/RIGHT and FRONT/REAR balance.
- If you wish to connect only two speakers, connect these to the Front speaker sockets and adjust the Fader control to the FRONT speakers.
- To protect against water ingress, replace the protective covers on any unused speaker sockets.



NOTE:

1. The GR350BT is a 4-speaker system that requires two separate wires for each speaker. Do not touch the speaker wires together or allow them to touch other wiring or the vessel ground (earth)..

2. The use of speakers with an impedance of LESS than 4 Ohms is NOT recommended, as they will cause excessive loading of the GR350BT's output circuit and may result in the radio overheating. A range of GME speakers are available from your local GME retailer.

SPEAKER ADAPTOR LEADS

- ① White Stripe

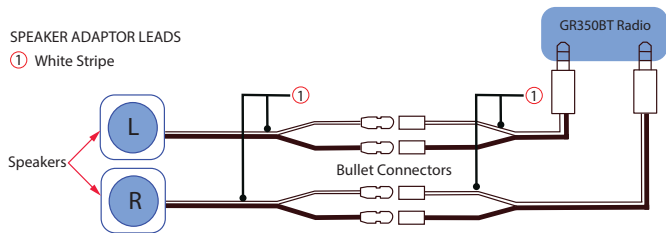

- After the external stereo speakers are connected, you can adjust the audio between the LEFT/RIGHT and FRONT/REAR speakers using the Balance and Fader functions available via the Control Knob.

ANTENNA INSTALLATION

This section provides instructions on the ideal way to install and connect the antenna for your radio.

- It is essential to select a good quality AM/FM antenna. A poor quality antenna will not provide good performance. For information on suitable AM/FM antennas, please refer to the GME website: <https://www.gme.net.au/boating-and-fishing.aspx?f=AM/FM-and-Mobile-Phone> or contact your Local GME dealer.
- Mount the antenna in a position as high as practically possible to ensure good reception, especially in areas of low signal strength.
- When installing the antenna, ensure a minimum clearance of around 20 cm from bow or stern rails or windscreen frames etc.
- Ideally, place the antenna at least 1 meter away from two-way radio antennas to minimise interference from radio transmissions.

Connecting the antenna to your radio:

Plug the antenna lead into the flyleaded antenna socket on the rear of the unit. The socket accepts a standard AM/FM radio bayonet connector.

NOTE: The antenna socket is not waterproof.

Noise Suppression

The inherent design of FM radios results in a high level of resistance to ignition and electrical interference however electrical interference on AM radio can be almost impossible to eliminate. To help minimise interference, take extra care during the installation.

- Route the DC battery leads, the antenna lead or any accessory wires away from the engine compartment, ignition or alternator wiring. A suppression kit may also help to reduce excessive electrical noise. Contact your dealer or radio installer for more information.
- If the interference you are experiencing is from other nearby electronic equipment such as a depth sounder, try to keep the depth sounder's DC leads and transducer cable well away from your GR350BT's wiring.

Waterproofing the connections

- After installation, the power, speaker and antenna connectors should be wrapped in waterproof tape (or similar) to minimise the risk of corrosion or water damage.
- Do not use normal electrical tape as this will not provide an adequate seal against water.
- The connectors should be positioned where they are not directly exposed to the elements.

CONTROLS

The controls and buttons you can use on the radio are displayed in the graphic below.

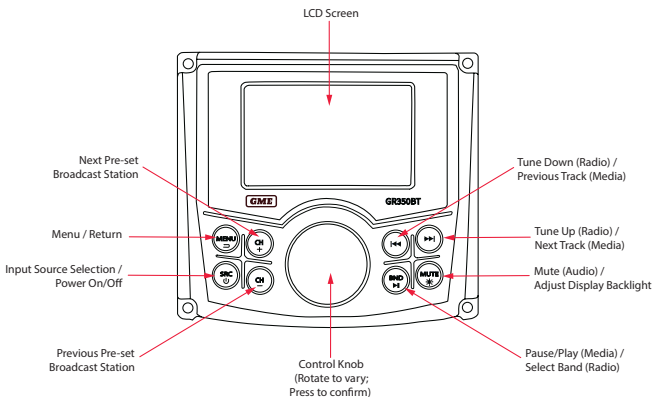

GENERAL OPERATION

POWER ON/OFF

- To turn the GR350BT radio on, press the **SRC** button. The unit will display the GME logo, and resume in the mode and settings that were selected when last turned off.
- To turn the radio off, press and hold **SRC** button. The unit will display 'Good bye / Power Off Now', and switch off.

MAIN MENU

To access the main system menu (home screen):

1. Briefly press the **Menu** button. The main menu will be displayed with the current source highlighted, as illustrated below.

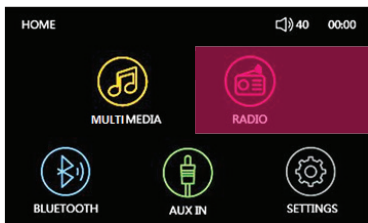

2. Rotate the control knob, or briefly press the **Tune Down** or **Tune Down** buttons to select between the following sources: Multimedia, Radio, Bluetooth, Aux In, Settings.
3. Press the control knob to confirm the selection. The radio will switch to the selected source and return to the normal display
4. To exit the menu screen at any time briefly press the **Menu** button.

SETTINGS SUBMENU

Using the procedure above, select **Settings** from the main menu to set the System Time, Time format (12/24 Hours), keypress beep on/off, check battery voltage, restore factory settings, and to confirm the software version.

TO ACCESS THE SETTINGS SUBMENU

1. Briefly press the **Menu** button. The main menu will be displayed with the current input source highlighted.
2. Rotate the control knob to highlight **Settings**.

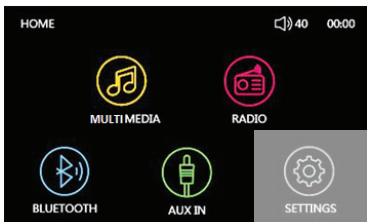

3. Briefly press the control knob to display the **Settings** sub-menu with the available options.

SETTING THE SYSTEM (CLOCK) TIME:

1. Access the **Settings** sub-menu as detailed in the previous section.
2. Briefly press the control knob to highlight the current system time.

| SETTING | |
|-------------------------|--------------|
| System Time | 12.00AM |
| Time Format | 12/24 Format |
| Beep | ON |
| Voltage | 13.8V |
| Restore Factory Setting | NO |
| Version | GR350_M0.1.0 |

3. Rotate the control knob to adjust the Hours.

4. After setting the Hours, briefly press the control knob. The Minutes will be highlighted in yellow.
5. Rotate the control knob to adjust the minutes.
6. Briefly press the control knob to confirm and store the time.
7. Briefly press the **Menu** button twice in succession to return to the normal display, or allow the **Settings** screen to timeout after 10 seconds.



NOTE: The time setting will be retained as long as the 12V power source remains connected. If the 12V power source is disconnected, the time setting will be lost and will need to be reset once power is restored.

SETTING THE TIME FORMAT (12 or 24 Hour)

1. Access the **Settings** sub-menu.
2. Rotate the control knob to scroll to **Time Format**.
3. Briefly press the control knob to highlight the current time format.
4. Rotate the control knob left or right to select between 12 or 24 Hour format.
5. Briefly press the control knob to confirm your selection.
6. Briefly press the **Menu** button twice in succession to return to the normal display, or allow the **Settings** screen to timeout after 10 seconds.

SETTING THE SYSTEM (CLOCK) TIME:

1. In **Settings**, rotate the control knob to highlight **System Time**.
2. Press the control knob to highlight the time.
3. Rotate the control knob left or right to adjust the Hours.
4. When the Hours have been set, briefly press the control knob. The 'Minutes' will be highlighted.
5. Rotate the control knob to adjust the Minutes.
6. Briefly press the control knob to confirm and store the time.

7. Briefly press the **Menu** button twice in succession to return to the normal display.

Note: The time setting will be retained as long as the 12V power source remains connected. If the 12V power source is disconnected, the time setting will be lost and will need to be readjusted once the power is restored.

SELECTING KEYPRESS BEEP TONE:

By default, the GR350BT radio provides a confirmation beep whenever a front panel button is pressed. If preferred, the beep can be disabled.

To disable/enable the beep:

1. Access the **Settings** sub-menu.
2. Rotate the control knob to highlight 'Beep'.
3. Briefly press the control knob, Beep On/Off will be highlighted.
4. Rotate the control knob to select between ON or OFF.
5. Briefly press the control knob to confirm your selection.
6. Briefly press the **Menu** button twice in succession to return to the normal display or allow the **Settings** screen to time out after 10 seconds.

VOLTAGE

The GR350BT radio continuously monitors and displays the DC supply (battery) voltage. This feature is for utility and is not user adjustable.

Restore Factory Setting (SYSTEM RESET):

When installation is complete, it is recommended to reset the radio to ensure it is ready to operate for the first time.

If at any time the controls do not seem to work (after replacing the vessel's battery, for example), perform a reset which will restore the radio to its default factory settings.

NOTE: By performing a system reset all station preset memories, tone control settings, and clock time will be lost and will need to be re-entered.

1. Access the **Settings** sub-menu.
2. Rotate the control knob to highlight 'Restore Factory Setting'.
3. Briefly press the control knob. Restore factory setting 'NO' will be highlighted.
4. Rotate the control knob to select 'YES'.
5. Briefly press the control knob to confirm your selection. The radio will then be restored to its default factory settings.
6. Briefly press the **Menu** button twice in succession to return to the normal display, or allow the **Settings** screen to time out after 10 seconds.

VERSION

This represents the current firmware version of the GR350BT radio, and is for reference only. It is not user adjustable.

INPUT SOURCE SELECTION SRC

Press the **SRC** button repeatedly to cycle through the radio's available input sources. The icon for the selected input source will be displayed. Inputs include AM/FM tuner, USB Flash Drive, Auxiliary input and Bluetooth®.



NOTE: If no USB Memory Drive is connected, The radio will automatically skip over that input source, which cannot be selected. Whenever the radio is switched on, it will automatically attempt to return to the input source that was last selected.

BACKLIGHTING

While the GR350BT is switched on, press and hold the **Mute** button to change the brightness of the Screen Backlighting. There are two levels of display backlighting available: Bright (default) and Dim.

ADJUSTING THE SOUND

The GR350BT radio's volume, bass, midrange, treble, balance, fader, loudness and graphic equaliser settings are adjusted sequentially using the large control knob. When adjusting an audio parameter, the corresponding icon will appear on the display. If no adjustments are made for 5 seconds, the icon will time out to the normal display.

ADJUSTING THE VOLUME

Rotate the control knob clockwise to increase or decrease the volume. The volume level is displayed on the LCD in values from 0 (min) to 45 (max).



NOTE: It is not recommended to operate the GR350BT at very high (> 40) volume levels for extended periods of time as this may cause the unit to overheat and possibly shut down in order to protect the internal circuitry. If shutdown occurs, allow the unit to cool sufficiently before switching it back on.

ADJUSTING THE BASS

1. Briefly press the control knob repeatedly until the Bass icon is displayed.
2. Rotate the control knob to adjust the bass. The selected setting will be displayed on the LCD in values from -10 (min) to +10 (max). For a flat bass response, select 0 (Zero).

ADJUSTING THE MIDRANGE

1. Briefly press the control knob repeatedly until the Mid icon is displayed.
2. Rotate the control knob adjust the Midrange. The selected setting will be displayed on the LCD in values from -10 (min) to +10 (max). For a flat Midrange response, select 0 (Zero).

ADJUSTING THE TREBLE

1. Briefly press the Control Knob repeatedly button until the Treble icon is displayed.
2. Rotate the control knob to adjust the treble. The selected setting will be displayed on the LCD in values from -10 (min) to +10 (max). For a flat treble response, select 0 (Zero).

ADJUSTING THE BALANCE

The Balance setting adjusts the audio balance between the left and right speakers.

1. Briefly press the control knob repeatedly until the Balance icon is displayed.
2. Rotate the control knob to adjust the Balance towards the right speaker. The Balance setting will be displayed in values of 1 to 9. Rotate the control knob anticlockwise to adjust the Balance towards the left speaker. The Balance setting will be displayed in values of -1 to -9. A setting of 0 (Zero) indicates the Balance is set equally between both left and right speakers.

ADJUSTING THE FADER

The Fader setting adjusts the audio balance between the front and rear speakers.

1. Briefly press the control knob repeatedly until the Fader icon is displayed.
2. Rotate the control knob clockwise to adjust the balance towards the front speakers. The Fader setting will be displayed in values of 1 to 9. Rotate the control knob anticlockwise to adjust the Fader towards the rear speakers. The Fader setting will be displayed in values of -1 to -9. A setting of 0 (Zero) indicates the Fader is set equally between both Front and Rear speakers.

ADJUSTING THE LOUDNESS

1. Briefly press the control knob repeatedly until the Loudness is displayed.
2. Rotate the control knob to switch the Loudness ON or OFF.



NOTE: It is not advisable to enable the Loudness function in conjunction with high base levels, particularly at high volume levels, as audio distortion may result.

ADJUSTING THE GRAPHIC EQUALISER

The GR350BT radio has three preset Graphic Equaliser settings to enhance your audio listening experience: Classic, Rock and Pop. Each setting provides a preset adjustment of bass, midrange and treble settings to suit the selected music style.

To select an equaliser setting:

1. Briefly press the control knob repeatedly until the EQ icon is displayed.
2. Rotate the control knob to scroll through equaliser settings.
3. Press the control knob to select the desired option.

If you prefer to manually adjust the Bass, Midrange and Treble controls, set the equaliser to 'Off'. The bass, midrange and treble settings can now be selected and adjusted manually using the control knob.

ADJUSTING THE AUDIO MUTE

The Mute feature allows the radio's sound to be temporarily disabled without affecting any other settings. This is useful when making calls on your two-way radio or mobile phone, or during a local conversation where the radio sound is distracting.

To mute the radio:

- Briefly press the **Mute** button. The audio will be temporarily muted, and no sound will be heard from the speaker. While the sound is muted, the speaker icon on the display will exhibit no numerical value.

- To cancel the Mute selection and restore the sound to its previous level, briefly press the **Mute** button again.

AM/FM RECEIVER OPERATION

The GR350BT radio incorporates AM/FM Broadcast receivers with two (2) AM and three (3) FM bands respectively.

SELECTING THE AM/FM RECEIVERS

- Briefly press the **SRC** button repeatedly to cycle through the input sources.

OR

1. Briefly press the **Menu** button to access the main menu.
2. Rotate the control knob, or press the **Tune Up** or **Tune Down** buttons to select radio.
3. Press the control knob to select the AM/FM receivers.

THE RADIO SETTINGS MENU

The Radio Settings menu allows you to activate/deactivate features and alter parameters within the AM/FM receiver bands.

To access the Radio Settings Menu:

- Whilst in Radio Mode, press and hold the **Menu** button.

To Exit The Radio Settings Menu:

1. Briefly press the **Menu** button. OR
2. Allow it to time out after 15 seconds and return to the normal display

TUNING FOR STATIONS

MANUAL FREQUENCY TUNING

To manually tune the radio to the desired frequency, briefly press the **Tune Up** or **Tune Down** buttons. The frequency will be shown on the display at each button press.

SCANNING FOR STATIONS

Press and hold the **Tune Up** or **Tune Down** button to automatically scan for stations in the direction selected. The scanning will stop when a station is found, and the corresponding frequency will be displayed.

SELECTING AMERICAN (USA) OR EUROPEAN RECEIVER STANDARDS

The GR350BT radio supports both European and American (USA) receiver Standards. These settings control the different band edges and frequency tuning steps used by these countries (for details on frequencies and tuning steps. See the 'Specifications' section at the end of this manual.

When first connected, the radio will default to the 'European' setting which is compatible with most countries (including Australia). For operation in the USA, select the 'American' country setting.

SWITCHING BETWEEN RECEIVER STANDARDS

Switching between 'European' and 'American' receiver standards may be accomplished in the following ways:

- Press and hold the **BND** button. The radio will display 'Switch To American' to confirm the selected receiver standard before timing out.

OR

1. Access the **Radio Setting** menu by pressing and holding the menu button.
2. Rotate the control knob to highlight 'Radio Region' as described in the steps that follow.
3. Briefly press the control knob until 'European' is highlighted.
4. Rotate the control knob to select 'American'.

5. Briefly press the control knob to confirm the selected receiver standard.
6. Briefly press the **Menu** button twice in succession to return to the normal display, or allow the Radio Setting menu screen to time out after 15 seconds. The radio will have switched to the selected band as evidenced by the corresponding icon on the display.

MEMORY LOCATIONS

The GR350BT radio has 6 memory locations allowing up to 6 frequencies to be stored and recalled within each band. Because there are two identical AM bands and three identical FM bands, this provides for 12 AM and 18 FM preset station memories.

There are two ways of storing stations in the preset memory locations: Manually, or by using the Automatic Music Search (AMS) function.

Manually locating and storing station frequencies in the preset memories:

1. Press the **BND** button repeatedly to select the required band.
2. Briefly press the **Tune Up** or **Tune Down** button to manually step through the frequencies. Or press and hold the **Tune Up** or **Tune Down** button to automatically scan for the next station.
3. Once the required station is tuned, press and hold the control knob. The radio will display 'SAVING' and the selected station will be allocated to the first preset location.
4. Press the **CH+** or **CH-** button to select the next preset location and repeat steps 2 and 3 above.
5. If more than six stations memories are required, press the **BND** button to select the next band and continue the steps above to store further stations.

Storing station frequencies using the automatic Music Search (AMS) feature:

The AMS feature allows the GR350BT radio to search the selected AM or FM bands for stations and automatically store the first 12 (AM) and 18 (FM) stations into the preset station memory locations. Scanning will start at the lowest frequency in the band and scan upwards storing stations as they are located.



Note: The AMS function will overwrite all stations that were previously stored in the station memories

To store only the strongest stations, select 'LOCAL' mode before scanning.

Activating the AMS feature:

1. Access the Radio Setting menu by pressing and holding the **Menu** button.
2. Rotate the control knob to scroll to 'AMS'.
3. Briefly press the control knob to Highlight AMS 'NO'.
4. Rotate the control knob to select AMS 'YES'.
5. Briefly press the control knob to Initiate the AMS Feature. Radio Stations will be progressively stored into the station presets for that band.
6. When the AMS scan has completed, the radio will switch to the AM1 or FM1 band, tuned to the first station stored in memory location 1 which will appear highlighted on the display.

Recalling Station Memory:

The two ways to recall the preset station memory are detailed in the sections that follow.

Recalling station memories using the CH+ and CH- buttons

1. Briefly press the **CH+** button to skip to the next preset station memory location.
2. Briefly press the **CH-** button to skip to the previous preset station memory location.

3. By continuously pressing these buttons you can access all preset stations within each respective band. To do this, briefly press the **BND** button to select the desired band.

Recalling station memory by using the Radio Setting menu:

1. Access the Radio Setting menu by pressing and holding the **Menu** button.
2. Rotate the control knob to scroll to 'Frequency'.
3. Briefly press the control knob. The current station frequency and preset memory location will be highlighted e.g. 90.5[1/18].
4. Rotate the control knob to scroll through the Station Frequencies corresponding to the preset memory locations e.g. 104.9[15/18].
5. Briefly press the control knob to select the desired station frequency and its corresponding preset memory location.
6. Briefly press the **Menu** button twice in succession to return to the normal display, or allow the Radio Setting menu screen to time out after 15 seconds. The radio will be observed to have switched to the selected preset station and frequency band.

LOCAL MODE

Sometimes very strong radio transmissions can interfere with the reception of other stations on adjacent frequencies resulting in distortion of the desired signal.

The Local Mode controls the receiver's sensitivity. The GR350BT radio can be set to high sensitivity for long distance reception, (LOCAL OFF) the default setting. Or it can be set to low sensitivity for local reception (LOCAL ON) which may help reduce interference.



Selecting LOCAL ON when using the AMS feature will help to reduce the strength of distant weaker stations, allowing only the stronger local stations to be stored in pre-set memory locations.

To switch between Local Mode OFF and ON:

1. Access the Radio Setting menu by pressing and holding the **Menu** button.
2. Rotate the control knob to scroll to 'LOCAL'.
3. Briefly press the control knob to highlight LOCAL 'OFF'.
4. Rotate the control knob to select LOCAL 'ON'.
5. Briefly press the control knob to enable the LOCAL Function.
6. Briefly press the **Menu** button twice in succession to return to the normal display or allow the Radio Setting menu screen to time out after 15 seconds.
7. To deactivate the Local function, repeat the above steps selecting Local 'OFF'. The receiver will now be more sensitive to distant stations.

When the GR350BT radio returns to the normal display mode, the 'LOC' icon will be present at the top of the display if LOCAL ON is selected. If 'LOC' is not visible, then distance reception is selected.

STEREO/MONO SELECTION

The STEREO/MONO feature is used to switch between STEREO (the default setting) or MONO reception while on the FM Bands. For normal listening on the FM bands, the Stereo option should be selected. However if FM signals become weak or noisy, select MONO to disable stereo detection and improve the quality of the reception.

To switch between Stereo and Mono FM reception:

1. Access the Radio Setting menu by pressing and holding the **Menu** button.
2. Rotate the control knob to scroll to 'STEREO'.
3. Briefly press the control knob to highlight STEREO 'ON'
4. Rotate the control knob to select STEREO 'OFF'
5. Briefly press the control knob disable FM Stereo reception.

6. Briefly press the **Menu** button twice in succession to return to the normal display, or allow the Radio Setting menu screen to time out after 15 seconds.
7. To restore Stereo FM reception, repeat the previous steps selecting stereo 'ON'.

When the GR350BT radio returns to the normal display mode, the stereo symbol will be present at the top of the display if the following conditions are satisfied:

- Stereo Mode is enabled; and
- The radio Station is broadcasting in FM STEREO;
- The FM STEREO broadcast signal is of sufficient strength.

BLUETOOTH® OPERATION

Bluetooth® is a short-range wireless system used to transfer data between devices. Using Bluetooth via your smartphone or Bluetooth enabled portable media player, you can stream A2DP audio directly to your GR350BT radio.

To select Bluetooth:

- Briefly press the **SRC** button repeatedly to cycle through the GR350BT's available input sources.

OR

1. Briefly press the **Menu** button to access the main menu.
2. Rotate the control knob, or briefly press the **Tune Up** or **Tune Down** buttons to select Bluetooth.
3. Briefly press the control knob. The GR350BT radio will switch to the Bluetooth input Source. The large Bluetooth icon will appear illuminated and a small illuminated Bluetooth icon appear visible at the top of the display.

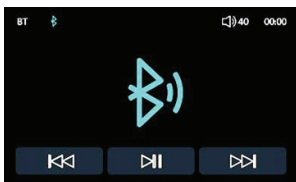

NOTE: The GR350BT supports music streaming only. It does not support the making or receiving of telephone calls..

PAIRING YOUR SMARTPHONE OR PORTABLE BLUETOOTH® MEDIA PLAYER FOR THE FIRST TIME

1. On your Bluetooth enabled smart phone or portable media player, select the **Settings** option and select **Bluetooth**. If Bluetooth is currently switched off on your device, switch it on.
2. View the list of available Bluetooth devices (some devices require you to tap 'Scan' to populate the list). The GR350BT will appear in the list

as 'GR350BT'. Select it as the desired device.

3. Your device will display 'Pairing' as the connection takes place.
4. The radio will emit a beep acknowledge to indicate that pairing/connection is successful and 'GR350BT' will appear on your smart phone's or media player's list of paired devices as 'Connected to Media Audio' or similar.



NOTE: The GR350BT unit can be in any mode of operation when pairing is performed.

TO RECONNECT TO AN ALREADY PAIRED DEVICE

1. On your smart phone or portable media player, select the **Settings** option and select 'Bluetooth'. If Bluetooth is currently switched off on your device, switch it on.
2. Locate 'GR350BT' in the list of paired Bluetooth devices, and select it to connect to the GR350BT.
3. The 'GR350BT' status in the list of paired Bluetooth devices will change from 'Paired' to 'Connected to Media Audio' or similar.

TO PLAY MUSIC FROM YOUR CONNECTED MEDIA DEVICE

Once paired with your Bluetooth device, to stream Music to the GR350BT.

1. Select the Bluetooth Input Source as described in the previous section.
2. Using your connected smart phone or media player, select and play your desired music. The sound will be heard through the GR350BT speaker system. For best results adjust the volume on your smart phone or media player to approximately 80%.

CONTROLLING YOUR CONNECTED MEDIA DEVICE

While playing music through Bluetooth, use the following buttons on your GR350BT radio to control the music playback.

1. Press the **BND** button to pause/play the current track.
2. To select and play the next track, briefly press the **Tune Down**

button.

3. Briefly press the **Tune Up** button to step to the start of the current track. Press the **Tune Up** button again to select and play the previous track.
4. Alternatively, you should also be able to control the music playback via your Bluetooth devices media player.

TO DISCONNECT/UNPAIR YOUR DEVICE FROM THE GR350BT

1. On your smart phone or portable media player, select the 'Settings' option and select 'Bluetooth'.
2. Locate and select 'GR350BT' in the list of paired Bluetooth devices and select the 'Disconnect' or 'Unpair' option to disconnect from the GR350BT.
3. The GR350BT will disconnect/unpair from your Bluetooth enabled device. On the BT interface display, the large Bluetooth icon will extinguish and the small illuminated Bluetooth Icon will disappear accompanied by a beep acknowledge.
4. Alternatively, the sections that follow explain how you can unpair your device using the GR350BT Bluetooth **Settings** menu.

ACCESSING THE BLUETOOTH SETTING MENU

The Bluetooth® Setting menu provides the capability of unpairing your Bluetooth device from the GR350BT radio. To access the menu:

1. Whilst in Bluetooth mode, press and hold the **Menu** button to access the Bluetooth setting menu.
2. Briefly press the control knob to highlight UNPAIR 'NO'.
3. Rotate the control knob to select 'YES'.
4. Briefly press the control knob. The GR350BT will unpair/disconnect from your Bluetooth device, accompanied by a beep acknowledge and return to the normal display.

BLUETOOTH RANGE

Under normal conditions, the Bluetooth® range should exceed 10 meters. However if you move your smart phone or media player out of range of your GR350BT radio, the Bluetooth connection will get drop off, and your music player will pause.

PLAYING AND VIEWING USB MULTIMEDIA FILES

USB FLASH MEMORY

The GR350BT radio accepts USB flash memory drives up to 16GB in size. When a USB flash memory drive is first inserted into the fly-leaded USB port, the radio will automatically switch to the USB input. The radio then begins playing the media on the memory drive with audio files taking priority. The USB symbol will appear at the top of the display.



NOTE: The GR350BT DOES NOT support portable USB hard drives or other USB devices that draw significant power resources from the USB port.

GME accepts no responsibility for data lost on USB Drives or other devices connected to the radio.

FILE FORMATS

The GR350BT can play a variety of multimedia files (music, video, photos) directly from a USB memory drive. The following file formats are supported:

| File Format | |
|---------------|--|
| Audio | MP3/WMA/OGG/FLAC/APE/AAC/AC3) |
| Video | MPEG 1/ MPEG 2/ MPEG 4-XVID/DIVX/H.264/H.263/ WMV9/RMVB |
| Photos | JPEG/BMP Maximum File Size 6.5 Mb |

For details on supported file formats, please refer to the Specifications section of this manual.



NOTE: Attempting to play an unsupported file will result in the GR350BT radio displaying the following text 'File Not Supported'.

GENERAL MP3 FILE INFORMATION

MP3 (MPEG-1 Layer 3) is a format for the compression of audio files to approximately 8% of their original size. This permits a large number of files to be stored on a single USB memory drive. The GR350BT radio will play MP3 and WMA files.

SELECTING THE USB INPUT SOURCE AND MEDIA FROM THE USB DRIVE

The USB Input Source may be selected in the following ways:

- Briefly press the **SRC** button repeatedly to cycle through the GR350BT's available input sources.

OR

1. Briefly press the **Menu** button to access the main menu.
2. Rotate the control knob, or briefly press the **Tune Up** or **Tune Down** button to select 'Multimedia'.
3. Briefly press the control knob to enter the multimedia selection menu.
4. Rotate the control knob, or briefly press the **Tune Up** or **Tune Down** button to select between Music, Movie, or Photo.
5. Briefly press the control knob to confirm your selection. The radio will play the selected media.
6. To step backwards sequentially to the previous display, briefly press the **Menu** button.



NOTE: If media files are not present on the USB memory drive, the screen will display as 'No Music File' / 'No Video File' / 'No Photo File', as applicable.

PLAYING MUSIC FILES

Playing music files on the GR350BT radio

1. Insert a USB flash drive containing audio files into the fly-leaded USB socket at the rear of the radio.
2. The GR350BT will automatically switch to the USB input source and begin playing the audio tracks from the first file location.

While playing, the display will continuously cycle the track number and playing time, the filename and the song title. If there is album art embedded within the file, this will be appear on the display.

TO SELECT MUSIC FROM YOUR USB MEMORY DRIVE:

1. Briefly press the **Menu** button to enter the Multimedia selection menu.
2. Rotate the control knob to select **Music**.

Playback/Pause

1. Press the **BND** button to pause the track.
2. Press the button again to resume playback.

Track Selection

1. To select and play the next track, briefly press the **Tune Up** button.
2. To select and play the previous track, briefly press the **Tune Down** button.

Fast forward/Rewind

- To advance through the present track at high speed, press and hold the **Tune Up** button.
- To rewind through the present track at high speed, press and hold the **Tune Down** button.

Release the button to resume play.

AUDIO PLAYBACK SETTINGS MENU

The GR350BT radio has the following audio playback settings:

- Repeat (All / One / Off)
- Random (Off / On)
- Intro Scan (Off / On)

To access the music playback settings menu:

Whilst in USB Music Playback mode, press and hold the **Menu** button.

To exit the music playback settings Menu:

- Briefly press the Menu **button**.

OR

- Allow it to time out after 15 seconds and return to the normal display.

REPEAT PLAY



The Repeat Play feature allows you to either repeat the current track or repeat all the songs in your music library.



NOTE: The default setting is Repeat All.

To change the Repeat settings:

1. Whilst in USB music playback mode, access the Setting menu screen by pressing and holding the **Menu** button.
2. Briefly press the control knob to scroll to highlight 'All'.
3. Rotate the control knob to select either All / One / Off, as required.
4. Briefly press the control knob to confirm your selection.

5. Briefly press the Menu button to return to the normal display or allow the Music setting menu screen to time out after 15 seconds.
6. For each respective setting the following icons will appear on the GR350BT display:
 - REPEAT ALL: A 
 - REPEAT ONE: 1 
 - REPEAT OFF: NIL

RANDOM PLAY

The Random play feature will select and play songs at random from your music library.



NOTE: The default setting is Random Off.

To change the Random Play settings:

1. Whilst in USB music playback mode, access the Setting menu screen by pressing and holding the **Menu** button.
2. Rotate the control knob to scroll to 'Random'.
3. Briefly press the control knob to highlight either OFF/ON as required.
4. Briefly press the control knob to confirm your selection.
5. Briefly press the **Menu** button to return to the normal display, or allow the Music Setting menu screen to time out after 15 seconds.
6. For each respective setting, the following icons will appear on the GR350BT display:
 - RANDOM ON: 
 - RANDOM OFF: NIL
7. To disable the Random play feature, repeat the above steps selecting Random 'OFF'.

INTRO SCAN

The Intro Scan feature progresses through the entire library of songs playing the first 10 seconds of each track, ending automatically after the first 10 Seconds of the final song and continuing with normal play.

To enable the Intro Scan feature:

1. While in USB Music playback mode, access the Setting menu screen by pressing and holding the **Menu** button.
2. Rotate the control knob to scroll to 'INTRO SCAN'.
3. Briefly press the control knob to highlight Intro Scan 'OFF'.
4. Rotate the control knob to highlight Intro Scan 'ON'.
5. Briefly press the control knob to initiate the Intro Scan feature.

To disable the Intro Scan and continue playing the current track:

- Briefly press the **CH+** or **CH-** button.

OR

- Briefly press the control knob to display your selected track on the Music Files display screen which will time out automatically after 5 seconds.

VIEWING MOVIE FILES

Insert a USB flash drive containing movie files into the fly-leaded USB socket at the rear of the GR350BT. The radio will automatically switch to the USB input source.

To select movies from your USB memory drive:

1. Briefly press the **Menu** button to enter the Multimedia selection menu.
2. Rotate the control knob to select 'Movie'.
3. Briefly press the control knob. The radio will play the movies progressively from the first file in your movie library.

Playback/Pause

To pause the movie, briefly press the **BND** button. Press the **BND** button again to resume playback.

Movie Selection

To select and view the next movie in the library, briefly press the **Tune Up** button. To select and view the previous movie, briefly press the **Tune Down** button.

Fast Forward/Rewind

To advance through the present movie at high speed, press and hold the **Tune Up** button. To rewind through the present movie at high speed, press and hold the **Tune Down** button.

Release the button to resume normal viewing at the current position.

MOVIE VIEWING SETTINGS MENU

The GR350BT radio incorporates the following movie viewing settings:

- REPEAT [ALL/ONE/OFF]
- RANDOM [OFF/ON]
- ASPECT RATIO [STRETCH/ORIGINAL]

RANDOM MOVIE VIEWING

The Random Viewing feature will select and view movies at random from your video library. The default setting is RANDOM OFF.

To change the Random Viewing settings:

1. Whilst in USB movie viewing mode, access the SETTING menu screen by pressing and holding the **Menu** button.
2. Press the control knob to scroll to 'Random'.
3. Briefly press the control knob to highlight either OFF/ON as required.
4. Briefly press the control knob to confirm your selection.
5. Briefly press the **Menu** button to return to the normal display, or allow the Movie setting menu screen to time out after 15 seconds.

- For each respective setting, the following icons will appear on the GR350BT display:
 - RANDOM ON: 
 - RANDOM OFF: NIL
- To disable the Random function, repeat the above steps selecting RANDOM 'OFF'.

ASPECT RATIO

The aspect ratio of an image describes the proportional relationship between its width and its height. It is commonly expressed as two numbers separated by a colon, as in 16:9.

The GR350BT has two settings:

- STRETCH:** The default setting, where the aspect ratio is automatically adjusted so the image fills the entire display.
- ORIGINAL:** The image is displayed in its original aspect format.

The images that follow display the difference between the Stretch and Original settings.

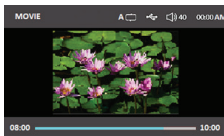
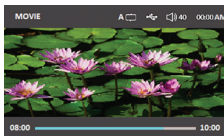

To change the aspect ratio:

- Whilst in USB movie viewing mode, access the SETTING menu screen by pressing and holding the **Menu** button.
- Rotate the control knob to scroll to 'ASPECT RATIO'.
- Briefly press the control knob to highlight 'STRETCH'.
- Rotate the control knob to select 'ORIGINAL'.
- Briefly press the control knob to confirm your selection.
- Briefly press the Menu button to return to the normal display, or allow the movie Setting menu screen to time out after 15 seconds.

VIEWING PHOTO FILES

Insert a USB flash drive containing JPEG/BMP Photo or image files into the fly-leaded USB socket at the rear of the radio unit. The radio will automatically switch to the USB input source. If music files are present on the USB memory drive, they will take priority, and you will need to select PHOTO as described in the sections that follow.

Selecting photos or images from your USB memory drive

1. Briefly press the **Menu** button to enter the MULTIMEDIA selection menu.
2. Rotate the control knob to select PHOTO.
3. Briefly press the control knob. The radio will display the Photos as a slideshow beginning with the first file. With the On Screen Display (OSD) Information timing out after 5 Seconds.

Slideshow Pause/View

To pause the slideshow, press the **BND** button. To resume, press the **BND** button again.

Photo Selection

To select and view the next image in the library, press the **Tune Up** button. To select and view the previous image, briefly press the **Tune Down** button.

PHOTO VIEWING SETTINGS MENU

The GR350BT radio incorporates the following Photo Viewing settings:

- BACKGROUND MUSIC [OFF/ON]
- FRAME RATE [Slow/Medium/Fast]

To access the photo viewing Settings menu:

While in USB Photo Viewing mode, press and hold the **Menu** button.

BACKGROUND MUSIC

If there are audio files present on your USB memory drive, the background music feature allows you to listen to music whilst viewing photos. The default setting is background music OFF.

To enable/disable the background music:

1. Whilst in USB photo viewing mode, access the 'Photo Setting' screen by pressing and holding the **Menu** button.
2. Briefly press the control knob to highlight Background Music 'OFF'
3. Rotate the control knob to highlight Background Music 'ON'.
4. Press the control knob to select Background Music 'ON'.
5. The radio will begin playing music files sequentially in the following manner:
 - From the first file in the music library on your USB Memory drive, if you have not previously played music.
 - Continue to play the song you were previously listening to before switching to PHOTO viewing, then continue sequentially through the files in your music library.

NOTE: While viewing photos with background music enabled the REPEAT, RANDOM and INTRO SCAN features are disabled.
6. Press the **Menu** button to return to the normal display or allow the PHOTO Setting menu screen to time out after 15 seconds.
7. To disable the background music, repeat the above steps, and select background music 'OFF'.

FRAME RATE:

The Frame Rate feature allows you to adjust the speed at which the radio advances to the next image during slideshow Photo viewing. The 3 setting options are as follows:

- SLOW: Advances at the rate of 1 frame every 8 seconds.
- MEDIUM: Advances at the rate of 1 frame every 4 seconds. This is the default setting.
- FAST: Advances at the rate of 1 frame every 2 seconds.

To change the frame rate:

1. Whilst in USB Photo Viewing mode, access the Photo Setting menu screen by pressing and holding the **Menu** button.
2. Rotate the control knob to highlight 'Frame Rate Medium'.
3. Briefly press the control knob to highlight Frame Rate 'Medium'.
4. Rotate the control knob to select either Frame Rate 'Slow, Medium or Fast'.
5. Briefly press the control knob to enable Frame rate 'Fast'.
6. Briefly press the **Menu** button to return to the normal display or allow the PHOTO Setting menu screen to time out after 15 seconds.

Searching and selecting files from USB media library

The GR350BT radio allows you to search for and select specific files on your USB memory drive media libraries for each media category. To perform this function:

1. Press the control knob while playing songs or viewing photos/movies.
2. Rotate the control knob, to scroll through the library for the media category until you find the desired file.
3. Briefly press the control knob. The radio will commence Playback/Viewing from the beginning of the selected file.

NOTE: During playback/viewing the radio automatically highlights the current media file being played or viewed.

AUXILIARY INPUT OPERATION

An auxiliary audio input fly-lead with a standard 3.5 mm stereo socket is fitted to the GR350BT rear panel to allow a direct audio connection from an external audio playback device or MP3 player. Connection is made using a 3.5 mm to 3.5 mm accessory lead. A suitable accessory lead (LE74) is available from your GME dealer.

Selecting the auxiliary audio input source

The Auxiliary Input Source may be selected in the following ways:

- Press the **SRC** button repeatedly to cycle through the radio's available input sources.

OR

1. Press the **Menu** button to access the main menu.
2. Rotate the control knob, or briefly press the **Tune Up** or **Tune Down** button to select 'AUX IN'.
3. Briefly press the control knob. The radio will switch to the auxiliary input source.

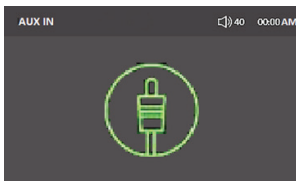

PLAYING MUSIC THROUGH THE AUXILIARY INPUT

1. Using an appropriate lead fitted with a standard 3.5 mm stereo photo plug, connect your auxiliary device to the fly-leaded auxiliary input socket at the rear of the GR350BT radio.
2. For best audio performance, set the volume on your media player to its mid-volume point. Then adjust it as necessary to achieve an output volume consistent with the volume level of the radio's AM/FM radio. If the output from the media player sounds distorted, reduce its volume level until the distortion has gone.
3. The selection and playback of your media files is controlled by the connected media player.

SPECIFICATIONS*

GENERAL

| Type | Description |
|-----------------------------|--------------------------------------|
| Compliance | Complies with: AS/NZS 61000.6.3:2007 |
| Frequency Range | AM and FM |
| Channel Set | European and USA Broadcast Bands |
| Supply Voltage Range | 11 – 16 VDC Negative Earth |
| Current Consumption | 7 Amps (Max) |
| Backup Current | Approximately 10 mA |
| Current Protection | 15 Amp 3 AG Fuse |

FM BROADCAST RECEIVER

| Type | Description |
|--------------------------------------|--|
| Frequency Range | 87.5 – 108 MHz (EU/AUS/NZ) 87.5 – 108 MHz (USA/ CANADA) |
| Frequency Step | 100 kHz |
| Intermediate Frequency | 10.7 MHz |
| Adjacent Channel Rejection | > 73 dB |
| Sensitivity | -101 dBm for 30 dB Sinad |
| Modulation Frequency Response | 60 Hz – 15 kHz |
| Station Memories | 18 |

AM BROADCAST RECEIVER

| Type | Description |
|-------------------------------|---|
| Frequency Range | 522 – 1620 MHz (EU/AUS/NZ) 530 – 1710 MHz (USA/CANADA) |
| Frequency Step | 9 kHz (EU/AUS/NZ) 10 kHz (USA/CANADA) |
| Intermediate Frequency | 455 kHz |
| Sensitivity | -101 dBm for 12 dB Sinad |
| Station Memories | 12 |

AUDIO AMPLIFIER

| Type | Description |
|--|---|
| Audio Output | 4 Channels x 40 W Peak-Peak = 160 W Peak-Peak @10% THD |
| Speaker Impedance | 4 Ohms (minimum) |
| Frequency Response | 20 Hz – 20 kHz |
| Bass Adjustment Range | ± 10 dB @ 100 Hz |
| Mid-range Adjustment Range | ± 10 dB @ 1.0 kHz |
| Treble Adjustment Range | ± 10 dB @ 10 kHz |
| Maximum Auxiliary Input Voltage | 1200 mV |

BLUETOOTH

| Type | Description |
|----------|----------------------|
| Version | 2.0 |
| Supports | A2DP audio streaming |

USB PLAYBACK

| Type | Description |
|-----------------------|----------------|
| Signal to Noise Ratio | 55 dB |
| Frequency Response | 50 Hz – 20 kHz |
| A/D Conversion Filter | 16BIT |
| USB Storage Capacity | 16 GB Max |

ENVIRONMENTAL

| Type | Description |
|-----------------------------|--|
| Ingress Protection Rating | IPX5 (Connectors not Included) Refer www.gme.net.au |
| Operating Temperature Range | -10° C to + 50° C |
| Solar Radiation | Front Panel UV stabilised |
| Compass Safe Distance | 200mm |

EXTERNAL CONNECTORS

| Type | Description |
|-------------------|--------------------------|
| DC Supply | 2 Pin Polarised Socket |
| External Speakers | 3.5 mm Phono Jacks |
| Auxiliary Input | 3.5 mm Stereo Phono Jack |

*All Specifications are typical and subject to change without notice or obligation

MULTIMEDIA SUPPORT

AUDIO

| Format | Bit Rate | Sampling Rate |
|------------------------------------|--------------------|---------------|
| MP3 | 16 kbps – 320 kbps | 8 – 48 kHz |
| WMA7, WMA8, WMA9 (CBR, VBR) | | |
| OGG (Vorbis) | | |
| FLAC | | |
| APE | | |
| AAC | | |
| AC3 | | |

VIDEO

| Format | Video Codec | Audio Codec | Resolution |
|-------------------------------------|---|---|------------------------------------|
| MPG (.mpg, .mpeg) | MPEG-1/MPEG-2 | Dolby Digital (AC3) LPCM MPEG-Audio (MP1/MP2/MP3) | 720 x 480 720 x 576 (30 fps) |
| AVI (.avi, .divx) | MPV4 DIVX3.xx/4.xx/5.xx/6.xx Xvid MPEG-1 | Dolby Digital (AC3) WMA/PCM/LPCM AAC-LC (2ch) MPEG-AUDIO (MP1/MP2/MP3) | 720 x 480 720 x 576 (30 fps) |
| DAT (.dat) | MPEG-1/MPEG-2 | Dolby Digital (AC3) LPCM MPEG-Audio (MP1/MP2/MP3) | 720 x 480 720 x 576 (30 fps) |
| FLV (.flv) | H.263 | - | 720 x 480 720 x 576 (30 fps) |
| RMVB (.rm, .rmvb, .rmv, .ra) | RV8/9/10 | COOK AAC-LC (2ch) Dolby Digital (AC3) | 1280 x 720 (30 fps) |

| Format | Video Codec | Audio Codec | Resolution |
|----------------------------------|---------------|--|------------------------------------|
| VOB (.vob) | MPEG-1/MPEG-2 | Dolby Digital (AC3) | 720 x 480 720 x 576 (30 fps) |
| MP4 / MOV (.mp4, .mov) | MP4V | Dolby Digital (AC3) WMA/PCM/LPCM AAC-LC (2ch) MPEG-AUDIO (MP1/MP2/MP3) | 720 x 480 720 x 576 (30 fps) |
| OGG Vorbis (.ogg) | - | OGG | - |
| ASF (.asf) | - | WMA, WMA7, WMA8, WMA9 (CBR, VBR) | - |

PHOTO

| Format | Maximum File Size |
|----------------------|-------------------|
| JPEG (.jpg) | 6.5 MB |
| Bitmap (.bmp) | 6.5 MB |

TROUBLE-SHOOTING

- **The unit will not turn on (no power).**
 1. Check the inline fuse. If blown, replace with a 15 amp 3AG type only.
 2. Check the power lead and all DC connections.
 3. If fitted, check that the vessel's battery switch is in the ON position.
 4. Check the DC (Battery) Voltage.

- **Blowing fuses.**
 1. Check the fuse rating. Correct rating is 15 Amp 3AG type.
 2. Check the DC power lead polarity.
 3. Check the speaker wires are not shorted together or to the vessels ground.
- **The unit has power, but there is no sound.**
 1. Check the 'Mute' feature is not enabled (rotate the control knob).
 2. Check the speaker connections. Ensure one or more of the speaker's wires are not shorted together or to the vessel's ground.
- **The sound is thin and lacks bass and/or stereo response.**

The speakers may be connected out of phase. Check the speaker wiring, it should be solid-to-solid and stripe to stripe.
- **The sound is crackly in one or both speakers.**

Check the speaker wiring connections at both the stereo and speaker terminals. Connections should be tight and free from corrosion.
- **The GR350BT radio shuts down on hot days.**

As the GR350BT radio incorporates protection against overheating, It is inadvisable to operate your unit at high volume levels (> 40) for long periods of time especially on hot days. If the GR350BT shuts down, allow it to cool sufficiently before switching it back on and reducing the volume.
- **Experiencing trouble getting good AM/FM reception.**
 1. Ensure that your AM/FM antenna is the correct type, and installed as high as practically possible with a clear, obstruction free all-round view. The higher the antenna is above the water, the better your reception will be.
 2. Check that you have selected the correct tuner region in the radio settings menu, as the default setting may be incorrect for your location. For Australia, the correct setting is 'European.'
 3. Check that your antenna connections are tight and free from corrosion.
 4. Check the routing of cables including any RCA cables.

Ideally, they should be run away from any other cable and or electric motors or potential sources of interference. Power cables are the worst source of interference and may be bundled together so you may not realize they are there.

5. Your antenna may be faulty and in need of replacement.

- **Transmitting (Push-to-Talk) on 27 MHz and/or VHF Marine Radio causes Interference on the GR350BT.**

- Ensure maximum possible separation between your AM/FM antenna and communications aerials. We recommend a minimum distance of One (1) Meter.
- Re-route your AM/FM Antenna Coaxial cable as far as practically possible from your communications equipment and their associated cables.

- **Experiencing engine noise through the GR350BT radio.**

This is generally NOT a fault with your GR350BT, rather a problem with your installation. In order to eliminate/minimize this attempt the following:

1. Check the grounding of the DC leads and antenna coaxial cable.
2. Re-route your antenna cable and DC Power lead to be as far as possible from the engine and other electrical equipment.
3. Install a noise suppression filter to your DC Lead (available from marine/auto electricians)
4. Have your vessels electrical/ignition system checked by a professional marine/ auto electrician

- **Media on my USB flash memory drive will not play or causes the GR350BT radio to lock up.**

- Check the capacity of your USB drive. The GR350BT radio accepts USB memory Drives up to a maximum capacity of 16GB.
- Check (on a PC) that your USB memory drive is formatted correctly. It should be formatted as FAT.
- Check that the formatting of your media files are consistent with those listed in the Specifications section in this manual. Incompatible files will not play.
- Low-grade USB memory drives may not be supported.



gme.net.au

Standard Communications Pty Ltd trading as GME.
17 Gibbon Road, Winston Hills NSW 2153, Australia
Part Number: 311116 Drawing Number: 51155-1