

2023

XO

CROSSOVER

Deep-V Hull Aluminium Boats



# WELCOME TO THE WORLD of extraordinary boating experiences

When it comes to boating, exceeding expectations and challenging current standard is the key to becoming a trailblazer. To be capable of offering innovative design solutions while simultaneously staying on trend with the continuously evolving requirements of modern boaters is what sets us apart from our competition.

Our mission is to take you beyond conventional and straight to the best, as we are determined to provide the ultimate experience for those looking for new levels of boating enjoyment. For us, it is the least we can do for all XO Crossover owners.

XO Crossover boats are top of the line, combining a deep-V shape hull that is manufactured from the best military grade aluminum in the market. With aesthetic design enabled by GRP, these boats are always ready to take you on new and exciting adventures.

Welcome aboard to the XO boating experience.



ULTIMATE  
DRIVING  
EXPERIENCE

# IN A CLASS OF ITS OWN

With XO Crossover, exceptional becomes new default. Continuously challenging the status quo, we keep developing our boats and taking our customers further, to dimensions and experiences that once seemed to be out of reach. Eternally stretching our comfort zone, we are always looking for new peaks to conquer – because that’s what adventurous boaters do.

When others stay in port, XO Crossover boats keep going. Our boats make exploring the most remote corners of the sea achievable – wherever your destination, no matter the time or conditions – ensuring that every time you head out, you return with the most unforgettable experiences.

By choosing the best materials, we guarantee smart and sturdy designs, with every detail carefully curated.

# ULTIMATE EXPLORER



A NEW LOOK  
AT QUALITY TIME | The  
EXPLR series





That thrilling feeling when the world is suddenly right at your fingertips - there is no turning back, at least not yet. Aboard any of our EXPLR fleet your inner explorer will be unleashed.



The  
EXPLR series





STEP TO THE  
WILD SIDE

with  
XO EXPLR 9





# XO EXPLR 9



Configure  
YOUR XO  
Crossover

Get ready to enjoy the XO Crossover philosophy to the extreme. The completely renewed XO EXPLR 9 takes you to all new dimensions when it comes to driving comfort, multi-purpose use and design, as it fully pays attention to the versatile needs of modern boaters. With smart upgrades, this boat has managed to develop even further into a genuine pathfinder for adventures, able to provide an even more comprehensive range of opportunities.



Compared to its predecessors, the new EXPLR 9 is even more stable and agile to drive. Bigger in size, lighter in weight, and easier to manoeuvre. The pilot and co-pilot can further enjoy the ride by opening the roof hatch, heightening their experience on the open water.

## MEASUREMENTS EXPLR 9

Overall length	m	8,57
Beam	m	2,55
Construction	hull/deck	ALU/GRP
Weight (excl. engines)	kg	2404
Draft to props	m	0,94
Outboard engines	hp	450
Fuel capacity	L	305
Max speed range	knots	45+
Passengers	pers	8
Berths	-	2
Dead rise at transom	°	DEEP-V 22 DEGREE
Hull material	-	MARINE ALUMINIUM
Classification	-	C

1. Suspension pilot & co-pilot seats
2. Spacious cabin for eight people
3. L-shaped sofa with king-size bed option
4. Roomy toilet + shower
5. Convenient aftdeck for 4 people
6. Storages under the deck

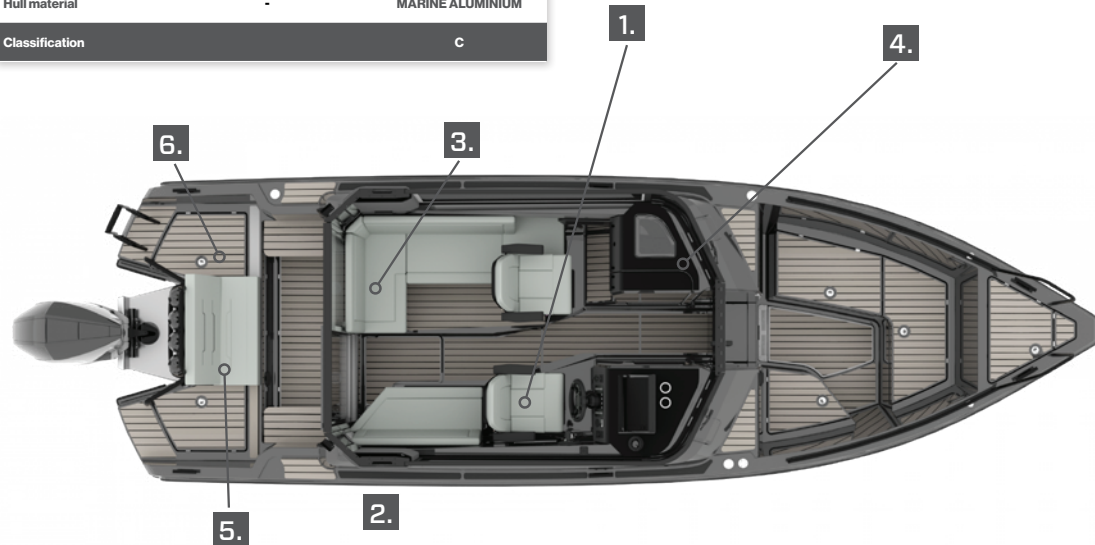

# XO EXPLR 9

Cabin boats rarely provide the kind of driving convenience the full suspension seats of EXPLR 9 do – opt to include a co-pilot seat. The exceptionally spacious and astoundingly soundproof cabin is outright ideal for rest and relaxation. A bed that stretches all the way to 230 cm, comfortable and well-equipped bathroom facilities, and a full-size refrigerator, ensure that the crew can make the most of their time at sea, no matter the how long the journey. Should the sunshine get too hot to handle, optional air-conditioning makes life in the cabin a sheer pleasure.



VKB-345

**DRIVEN BY  
AMBITION**

XO EXPLR 10 Sport



# XO EXPLR 10 Sport



Configure  
YOUR XO  
Crossover

There is simply no other boat as fun to drive as this one. While the deep-V hull structure defines every XO model, it is exceptionally aggressive in the XO EXPLR 10 Sport. As the hull heels along with the g-forces, the boat moves naturally, pushing the ultimate driving experience even further. Agile and responsive, especially considering its length, the EXPLR 10 Sport performs like the true sports vehicle it is, setting you up with plenty of power and extreme engine efficiency. For an exciting outing at sea, all you need to do is put the pedal to the metal and enjoy.



With its advanced hull, the EXPLR Sport 10 is first and foremost a driver's boat, but this model can smoothly adapt itself for many purposes. There is plenty of robust and functional space fit for commuter use and for adventurous trips towards more distant destinations. The quality can be seen, once again, in the intelligent details, making any kind of ride as convenient and exciting as it can possibly get.



## MEASUREMENTS EXPLR 10 SPORT

Overall length	m	9,4
Beam	m	2,5
Construction	hull/deck	ALU/GRP
Weight (excl. engines)	kg	2616
Draft to props	m	0,95
Outboard engines	hp	2 X 250
Fuel capacity	L	2 X 225
Max speed range	knots	45+
Passengers	pers	10
Berths	-	2-3
Dead rise at transom	°	DEEP-V 24 DEGREE
Hull material	-	MARINE ALUMINUM
Classification		C

1. Long and narrow waterline with deep-v hull
2. Optimal commuter cabin
3. Yacht style radar mast for search light and equipment
4. Bowrider style seat system + storages
5. Spacious aftdeck
6. Twin engine installation up to 2 x 250 hp

# XO EXPLR 10 Sport

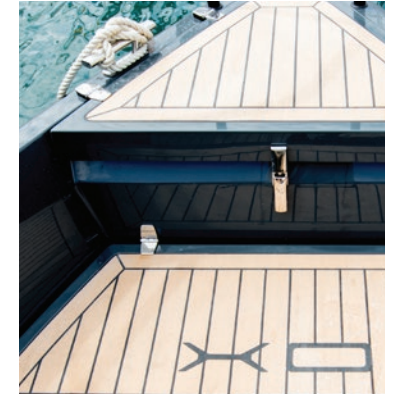
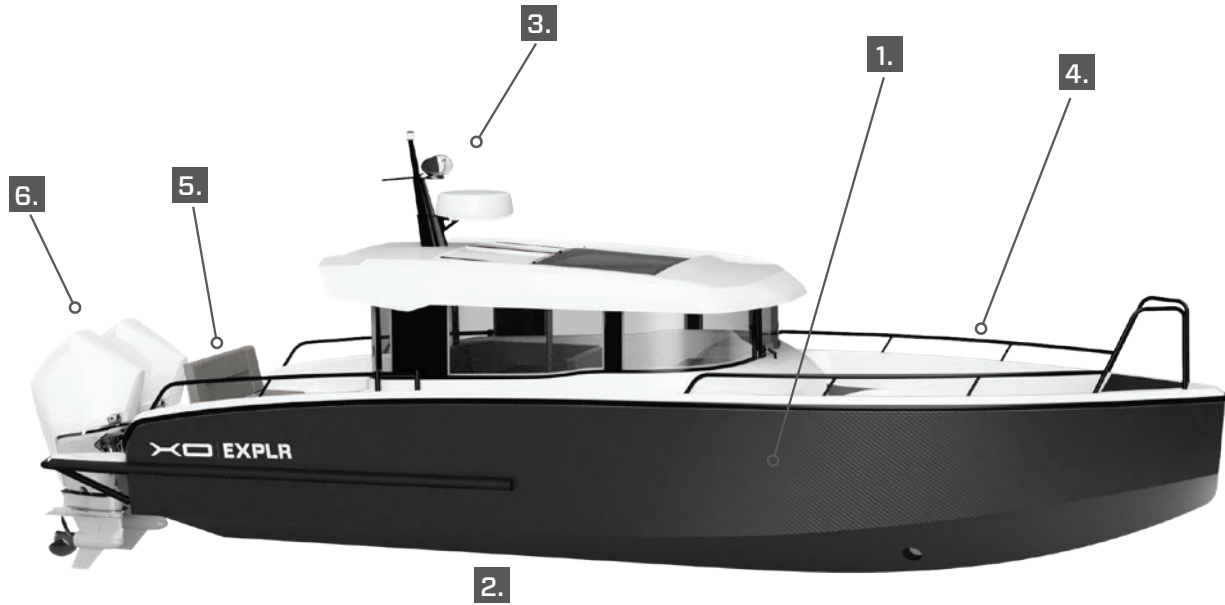



VKB-345

**A NEW  
DIMENSION**

**XO EXPLR 10 Sport+**



# XO EXPLR 10 Sport+



Configure  
YOUR XO  
Crossover

The most spontaneous adventures are the best adventures – day or night. Equipped with a front cabin, on the XO EXPLR 10 Sport+ you can make the most of a pleasant evening at sea and sleep comfortably on board. Come morning, you can up-anchor right where you set down. Experience the most breathtaking sunrises and sunsets in the EXPLR 10 Sport+.



Thanks to the sporty deep-V hull design along with sleeping quarters for two, the EXPLR 10 Sport+ seamlessly combines ultimate driving enjoyment with onboard comfort, even for extended periods of time. Make the most of the spacious outdoor layout by inviting a group of friends on a day cruise, or plan an intimate experience with your closest. While the EXPLR 10 Sport+ will take you even through the rough seas, an evening of entertainment while docked is also a fabulous possibility.

## MEASUREMENTS EXPLR 10 SPORT+

Overall length	m	9,4
Beam	m	2,5
Construction	hull/deck	ALU/GRP
Weight (excl. engines)	kg	2696
Draft to props	m	0,92
Outboard engines	hp	2 X 250
Fuel capacity	L	2 X 225
Max speed range	knots	45+
Passengers	pers	10
Berths	-	2+2
Dead rise at transom	°	DEEP-V 24 DEGREE
Hull material	-	MARINE ALUMINUM
Classification		C

1. Front Cabin with berth for two
2. Long and narrow waterline with deep-v hull
3. Yacht style radar mast for search light and equipment
4. Large sunbed area
5. Spacious aftdeck
6. Twin engine installation up to 2 x 250 hp

# XO EXPLR 10 Sport+

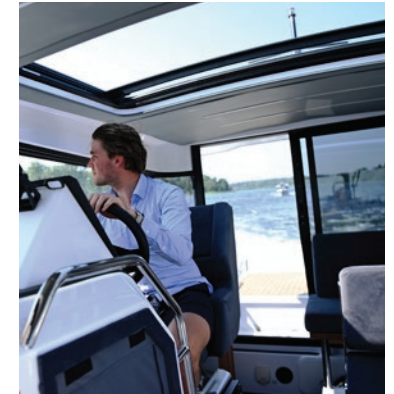
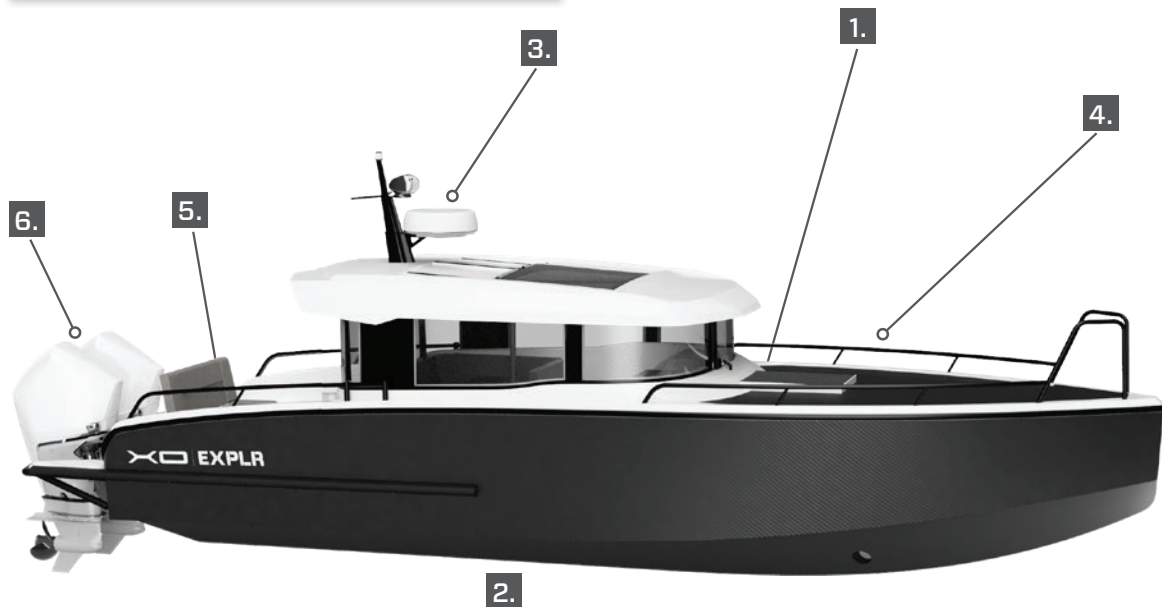



**Mile eater**

with the lowest  
center of balance  
**XO EXPLR 10 Sport+ IB**



# XO EXPLR 10 Sport+ IB



Configure  
YOUR XO  
Crossover

Smarter choices do not have to mean compromising. Thanks to the aluminum structure and robust construction, you can always enjoy carefree commuting or sports boating with XO EXPLR 10 Sport+ IB. On the other hand, if you suddenly feel like staying at sea overnight, there are berths for that. Convenience is, after all, part of the fun, and the EXPLR 10 Sport+ IB is just that; it comes with an inboard engine that adds both value and maximum enjoyment to any ride.



Issues such as maneuverability and fuel consumption always rear their ugly heads as your time at sea increases. But in our EXPLR 10 Sport+ IB boat, these problems won't stand in the way of your fun. As the inboard engine takes the center of gravity all the way to the bottom, the boat heels considerably less whilst lower running costs per nautical mile.



## MEASUREMENTS EXPLR 10 SPORT+ IB

Overall length	m	8,66
Beam	m	2,5
Construction	hull/deck	ALU/GRP
Weight (excl. engines)	kg	2714
Draft to props	m	0,95
Inboard engine (diesel/petrol)	hp	370-425
Fuel capacity	L	315
Max speed range	knots	40+
Passengers	pers	10
Berths	-	2+2
Dead rise at transom	°	DEEP-V 24 DEGREE
Hull material	-	MARINE ALUMINIUM
Classification		C

1. Front Cabin with the berth for two
2. Optimal cabin for commuting
3. Yacht style radar mast
4. Large sunbed area
5. Vast aftdeck
6. Diesel and petrol inboard options up to 400 hp

# XO EXPLR 10 Sport+ IB

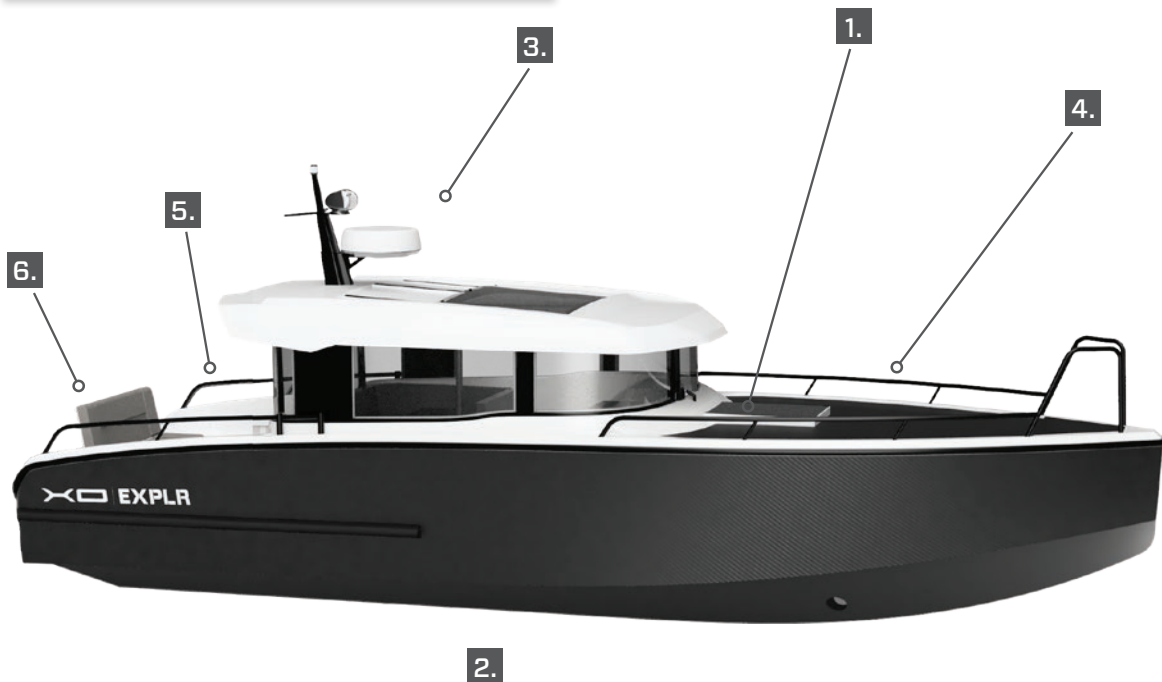



The  
EXPLR series



## Seeing things IN A NEW LIGHT

The XO EXPLR boats empower any boater in more ways than one. Choose the design that best suits your needs and achieve what used to be unachievable. Set your sights further than you have ever set before.



**BORN TO  
ROAM**

**The  
DSCVR series**



The time has come to break away. Head out somewhere far to enjoy the view, the water – and most importantly the ride.

Why not experience the utmost freedom in a way you have never experienced before? Untie the ropes, start the engine, and head towards the horizon, because extreme fun will never go out of style. Especially on our XO DSCVR series.



# The DSCVR series





SIMRAD

XO

TAKING YOU  
FURTHER

XO DSCVR 9 T-Top





# XO DSCVR 9 T-Top



Configure  
YOUR XO  
Crossover

Going beyond what is conventional requires determination, a virtue which applies to both the designers and owners of XO DSCVR T-Top. While conventional bowriders look for calm waters close by, the DSCVR 9 T-Top can take the crew even through the roughest of seas. After exhilarating excursions, the possibility of relaxing aboard the DSCVR 9 T-Top on the way back is a pleasure.



On the DSCVR 9 T-Top you can enjoy a full day of activities, thanks to features such as the vast sunbed area at the stern and integrated bar & dining area. The optional canopy helps make the design just outright perfect on a DSCVR 9 T-Top – rain or shine!

## MEASUREMENTS DSCVR 9

Overall length (excl. engines)	m	8,57
Beam	m	2,57
Construction	hull/deck	ALU/GRP
Weight (excl. engines)	kg	2319
Draft to props	m	0,94
Outboard engines	hp	450
Fuel capacity	L	305
Max speed range	knots	45+
Passengers	pers	8
Berths	-	SUNBED
Dead rise at transom	°	DEEP-V 22 DEGREE
Hull material	-	MARINE ALUMINUM
Classification	-	C

1. Suspension seats for pilot & co-pilot
2. Full size wetbar and dining area
3. Vast sunbed & sofa
4. Spacious toilet + shower
5. Dining table for 4-6 people
6. Bowrider style seat system + storages

# XO DSCVR 9 T-top

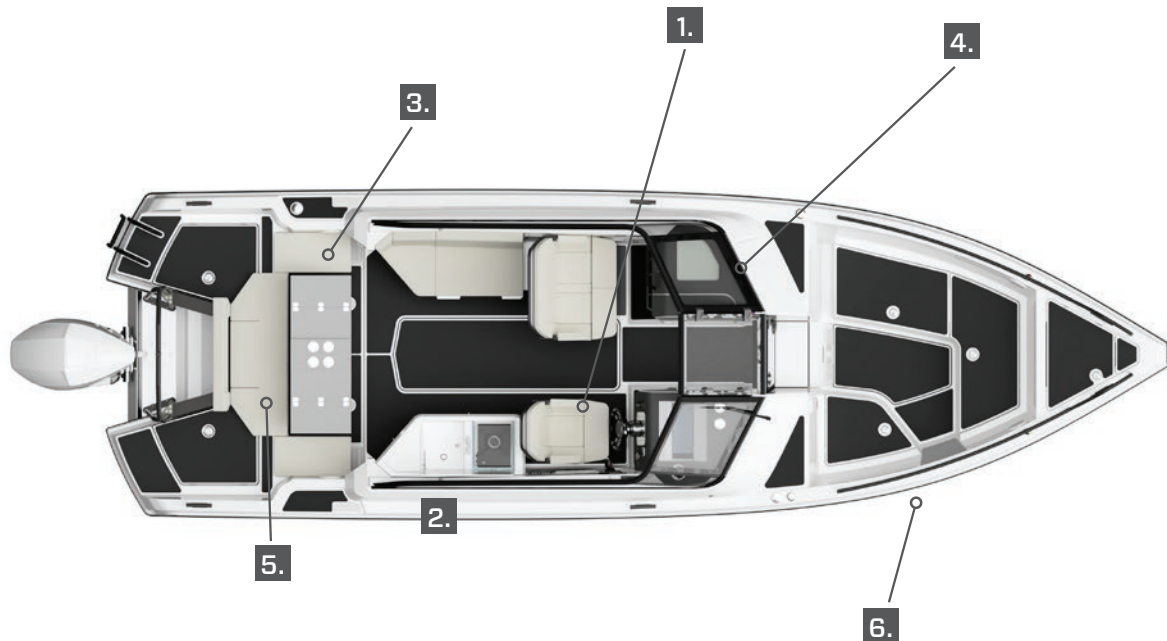

SUN, FUN  
AND A  
WHOLE  
LOT MORE

XO DSCVR 9 Open





# XO DSCVR 9 Open



Configure  
YOUR XO  
Crossover

There are many words to describe XO DSCVR 9 Open, but ordinary is not one of them. This boat shares the rebellious soul of a bowrider, yet its performance is similar to that of professional patrol boats and even speedboats. The DSCVR 9 Open takes you places in style thanks to its luxurious deck areas. The most robust day cruisers out there.



The military grade deep-V aluminum hull forms the foundation for this model. The stern area turns quickly into a party space with the inclusion of a barbeque that can be enjoyed by up to ten people; The DSCVR 9 Open is a great example of XO's ability to use every square inch efficiently and in a multi-purpose way for the benefit of the customer whatever their needs.

## MEASUREMENTS DSCVR 9

Overall length (excl. engines)	m	8,57
Beam	m	2,57
Construction	hull/deck	ALU/GRP
Weight (excl. engines)	kg	2259
Draft to props	m	0,94
Outboard engines	hp	450
Fuel capacity	L	305
Max speed range	knots	45+
Passengers	pers	8
Berths	-	SUNBED
Dead rise at transom	°	DEEP-V 22 DEGREE
Hull material	-	MARINE ALUMINUM
Classification	-	C

1. Suspension seats for pilot & co-pilot
2. Full size wetbar and dining area
3. Vast sunbed aft. deck & sofa
4. Spacious toilet + shower
5. Dining table for 4-6 people
6. Bowrider style seat system + storages

# XO DSCVR 9 Open

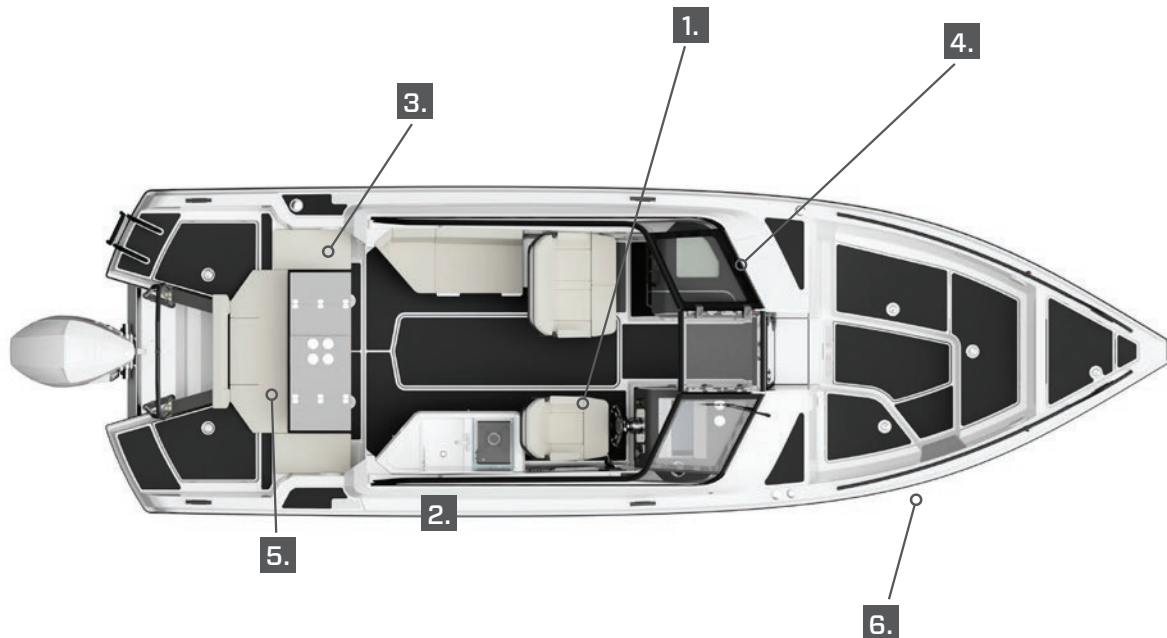

A blue boat is shown from a side-rear perspective, moving across a dark, choppy ocean. The sky is filled with a golden, hazy glow from a low sun, creating a dramatic sunset or sunrise atmosphere. The boat's cabin and windshield are visible, and a person can be seen inside. The text 'The DSCVR series' is overlaid in white on the lower left side of the image.

The  
DSCVR series





## On the sunny side OF THE SEA

Each of the models in our XO DSCVR fleet are reliable and robust for any type of situation and offer the most possibilities. Whatever the desire of the captain and crew, these boats will successfully stand up to the challenge.

# The DFNDR series

Last but not least, we offer you the XO DFNDR series. Strong, powerful, and beautiful, with a design just as thought-out as the rest of our XO boats, these boats set you up for a spectacular trip.



READY  
FOR A  
ROUGH  
RIDE

The DFNDR  
series

# The DFNDR series







WORLD  
PREMIERE

XO DFNDR 8



# XO DFNDR 8



Configure  
YOUR XO  
Crossover

Pushing the ideas of adaptability and configuration to new heights, you can semi-customize the boat for your unique needs to reach new sights from the arctic oceans to the tropical seas. Adapting the design philosophies of super yacht design by using ultra-strong and light aluminium in the hull and superstructure, deep-V hull DFNDR 8 is an excellent choice for exploring unknown waters.



XO DFNDR 8 can be configured from open sun top boat to a fully enclosed cabin boat by choosing the fixed side windows and hard aft wall as options. All the intelligent choices to configure the boat just for your needs make DFNDR 8 excellent for sport fishing, water sport or commuting. A combination of confidence and performance, the agile DFNDR 8 can reach +50 knots of speed with a twin 225 hp or single 450 hp engine. The boat layout combines a classic walkthrough layout with a semi-raised deck on the bow with a full-sized sun bed. The saloon sofa area turns overnight bed during longer journeys embracing XO's core dna of adventure. There is a separate toilet on the port side of the cabin.



## MEASUREMENTS DFNDR 8

Overall length	m	8,0
Beam	m	2,37
Construction	hull/deck	ALU/GRP
Weight (excl. engines)	kg	1900
Draft to props	m	0,8
Outboards engines	hp	2X225 - 450
Fuel capacity	L	400
Max speed range	knots	50+
Passengers	pers	8
Berths	-	2
Dead rise at transom	°	DEEP-V 23 DEGREE
Hull material	-	MARINE ALUMINUM
Classification	-	C

1. Twin Mercury V6 engines or single 450 hp V8
2. Optional suntop or fixed roof
3. Semi-raised deck on the bow
4. Full size cabin with berth for two and separate head
5. Optional fully enclosed cabin with aft ceiling door
6. The NEW aluminium Deep-V hull

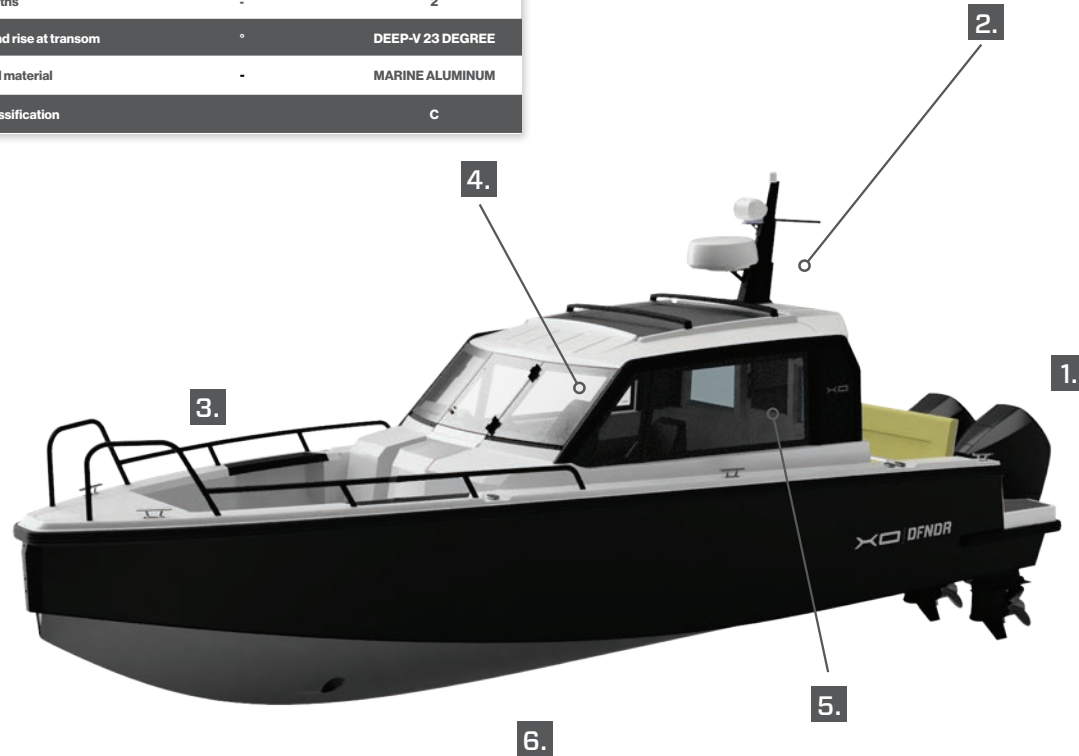

# XO DFNDR 8



DFNDR 8 is a genuine powerboat that maintains the uncompromising attitude and resilience of a true XO with a substantial cabin, thanks to its walkthrough design. The XO DFNDR 8 can host up to 8 passengers for day trips and expeditions.

# The DFNDR 8 series







# The DFNDR 8 series



The XO DFNDR 8 is designed with the driver in mind. XO's latest crossover design and aluminium deep-V hull give you the ultimate driving experience. Our test crew enjoyed the full-speed passage across the cold and icy waters with 100% confidence.



REDEFINING  
VERSATILITY

XO DFNDR 9



# XO DFNDR 9



Configure  
YOUR XO  
Crossover

After test driving the XO DFNDR 9, there is simply no turning back. This center console multi-purpose boat has everything you need to overcome the rough seas. Combining XO's classic deep-V shape hull, with the aesthetic design and the walkaround layout. The DFNDR 9 is a unique boat, entirely in a class of its own.



As the latest center console XO Crossover, the DFNDR 9 is a true pathfinder, enabling continuous exploring even in unknown waters. Enjoy up to even +50 knots of speed, or turn the aft deck and bow area into enormous sunbeds and just take it easy. The DFNDR 9 is first and foremost fun to drive, but ideal also for sport fishing and any type of professional use. Private head and berth for two allows for a comfortable overnight stay – meaning longer adventures and more quality time.



## MEASUREMENTS DFNDR 9 (OFFSHORE B CATEGORY)

Overall length	m	8,8
Beam	m	2,6
Construction	hull/deck	ALU/GRP
Weight (excl. engines)	kg	2710
Draft to props	m	0,99
Outboards engines	hp	2X225 - 450
Fuel capacity	L	450
Max speed range	knots	45+
Passengers	pers	8/6
Berths	-	2
Dead rise at transom	°	DEEP-V 23 DEGREE
Hull material	-	MARINE ALUMINUM
Classification	-	B /C

1. Twin Mercury V6 engines + Joystic controller
2. Two sunshades for aft- and fore sundeck's
3. Full size cabin with berth for two and separate head
4. Offshore suspension seats as a standard equipment
5. Optional glass cabin with oversized ceiling doors
6. The NEW Offshore B category Deep-V hull

# XO DFNDR 9

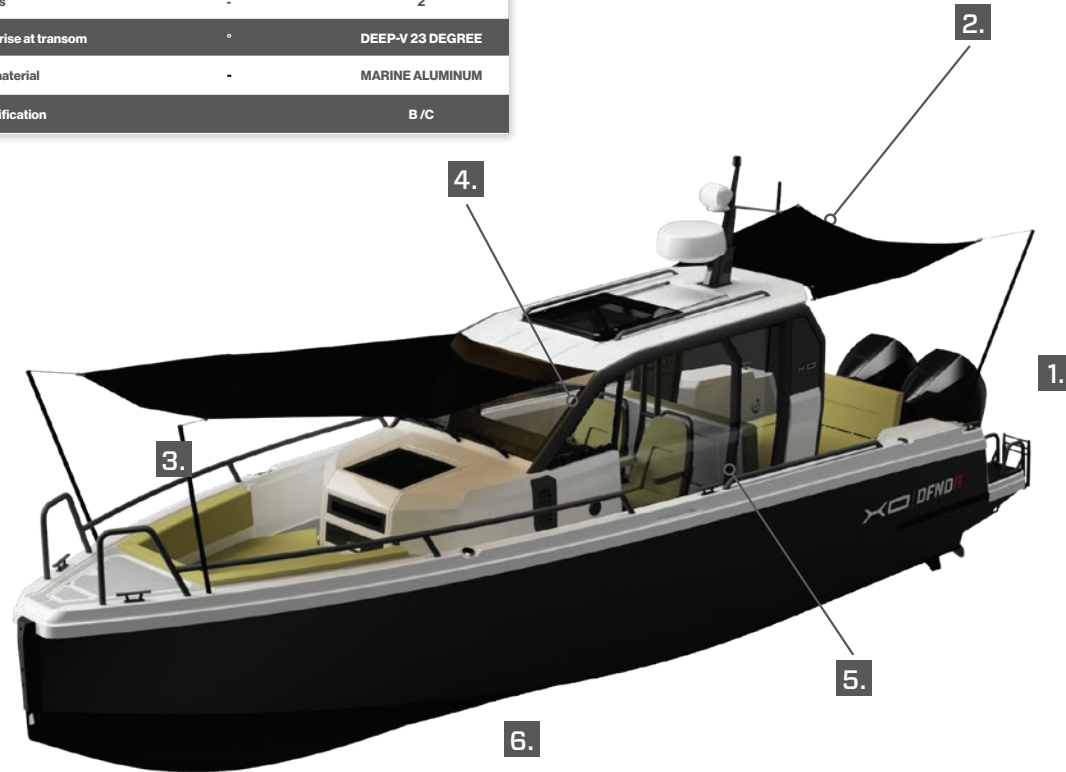



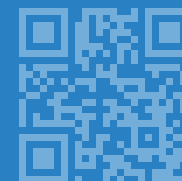

Follow the  
journey

## XO DFNDR Test drive

What would be a better test drive than to set out on a stormy autumn day and drive through the rough Baltic Sea from Finland to Sweden via its most remote outer islands? We packed our gear and set up drones and cameras to cover the journey between the Nordic capitals of Helsinki and Stockholm. With an XO, you can easily cross the heavy sea comfortably, even through a cruising speed of +30 knots. Visit our webpage and follow the 800 NM journey.

# The DFNDR 9 series

Did you know that the largest archipelago in the world is located in Finland? Our crew visited one of the uninhabited islands with the XO DFNDR 9 to test its new joystick pilot, and to see how easy it is to control the boat while parking it against the rocky shore.



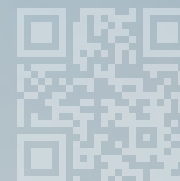

Follow the  
journey



# The DFNDR 9 series

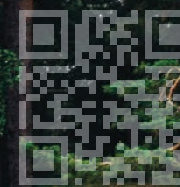

Follow the  
journey

The XO DFNDR 9 is designed with the driver in mind. XO's latest crossover design and deep-V hull enable you to have the experience of a lifetime. Our test crew enjoyed the full-speed passage across the narrow and shallow water with 100% confidence. Watch the full story from our website.



Only the best is good enough for true adventurers. With the world's leading hull design skills, combined with our own production facilities, form and function are meticulously achieved.





## DESIGNED TO PERFORM

The exceptional determination and versatile capabilities of our team ensure that each XO model is in on a level of its own, specific to the needs and wants of its passengers.

In every stage of the process, from the initial sketches to material selection and the actual production, we work without compromising, always striving for perfection. We take pride in manufacturing boats that are able to take their users above and beyond their wildest dreams – through each boats reliability, performance, and design.





# ALUMINIUM EXCELLENCE

The unique concept of XO Boats is in its design: the XO fleet has been created to exceed the needs of a wide variety of active users. The key to our boats' durability and excellent driving qualities is the deep-v aluminum hull. Not only a popular choice with professional boaters, aluminum has advantages that recreational boaters are able to enjoy as well. Aluminum is rigid and durable, yet extremely light and does not require constant maintenance. Aluminum is also a great material, as it is considered extremely safe: European safety regulations have classified aluminum as a category A1, meaning the highest possible rank for fire safety.

Not many materials are as easily accessible and recyclable as aluminum. In fact, up to 75% of all aluminum ever produced is still in use, thanks to its recycling qualities. Melting of pre-used aluminum requires only 5% of the energy used to produce the same amount of new aluminum.

According to IEA, the direct CO2 intensity of aluminum production has not fluctuated during the past couple of years, and in their Net Zero Emissions by 2050 Scenario it is estimated that emission intensity will decline 3% annually by year 2030. In short, the amount of energy and resources used to create aluminum will continue to diminish as the processes for recycling it advance even further.



Aluminum is not always used as 100% pure material and thanks to its versatility, other metals can be added to it for the purpose of fortifying some of its natural qualities – such as its sturdiness and waterproofness.

As an alloy, aluminum offers a similar performance level as advanced steels. Aluminum is also a very common material found across the planet, ensuring its durability.

All of these qualities are what makes aluminum the ideal material used in boating production – also in terms of sustainability. At the end of their exceptionally long life, aluminum boats can be fully recycled with very low energy costs. We at XO have known about the positive qualities of aluminum for many years and believe ourselves to be industry leaders, as the use of aluminum as a production material has just recently started to be accepted as a solution for the future in many other industries.

When the others are looking towards the horizon, XO is already there. We come from the northern, rugged and beautiful archipelago of Finland. These wild and endangered surroundings of the Baltic Sea have inspired our design and our philosophy: to create beautiful boats that can last a lifetime.

We care about the preservation of nature, which is why utilizing sustainable materials and finding new solutions to make the boating industry more environmentally friendly matters to us. The value of XO boats is not just in their appearance, but their versatility.



**FORERUNNER IN  
SUSTAINABILITY**





# THOROUGHLY IN A CLASS OF ITS OWN

At XO, our core is the hull. Every designed hull has a deep-V shape, manufactured from the best aluminum on the market. Aluminum as a material is rigid, sustainable, and durable, yet extremely light and does not require constant maintenance. It sets you up with a carefree ride without worrying about scratches or possible cracks after years of hard use. Able to withstand the most brutal conditions among the most wearing of waters, it is the perfect base to take you on any journey.

While aluminum ensures the best possible hull in the market, top-quality GRP makes it possible to design and produce interiors that are ideal for multi-purpose use. We use fiberglass in a way that adds value and versatility, and that helps make the most out of any moments at sea. The carefully thought-out details and industry-leading accessories such as the chosen audio systems, canopies, plotters, toilets, and upholstery make each of our XO models what they are. The best, at any purposeful use.







CROSSOVER



# DEALERS



[xoboats.com/dealers](https://xoboats.com/dealers)

## WHEN OTHERS STAY IN PORT

Each wave, gust of wind, and ride is different from the next. We design crossover boats that can handle any weather and water conditions, while at sea or docked.

2023

XO

CROSSOVER

Deep-V Hull Aluminium Boats



[xoboats.com](http://xoboats.com)