

**GARMIN®**

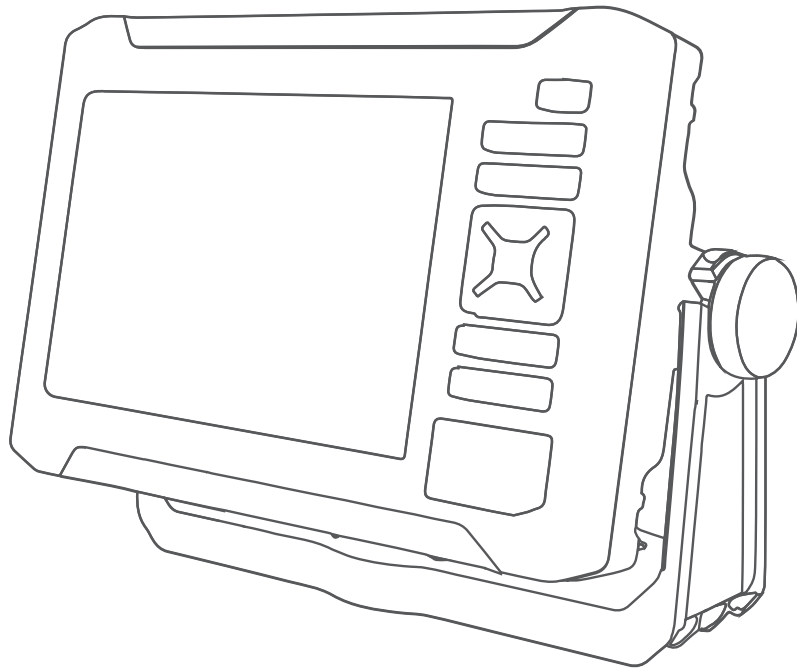

# **ECHOMAP™ UHD2 5X/7X**

---

**Owner's Manual**

© 2022 Garmin Ltd. or its subsidiaries

All rights reserved. Under the copyright laws, this manual may not be copied, in whole or in part, without the written consent of Garmin. Garmin reserves the right to change or improve its products and to make changes in the content of this manual without obligation to notify any person or organization of such changes or improvements. Go to [www.garmin.com](http://www.garmin.com) for current updates and supplemental information concerning the use of this product.

Garmin®, the Garmin logo, ActiveCaptain®, and BlueChart® are trademarks of Garmin Ltd. or its subsidiaries, registered in the USA and other countries. ECHOMAP™, Garmin ClearVü™, Garmin Connect™, Garmin Express™, Garmin LakeVü™, Garmin Quickdraw™, Garmin Navionics Vision+™, Panoptix™, and OneChart™ are trademarks of Garmin Ltd. or its subsidiaries. These trademarks may not be used without the express permission of Garmin.

Mac® is a trademark of Apple Inc., registered in the U.S. and other countries. microSD® and the microSD logo are trademarks of SD-3C, LLC. Standard Mapping® is a trademark of Standard Mapping Service, LLC. Wi-Fi® is a registered mark of Wi-Fi Alliance Corporation. Windows® is a registered trademark of Microsoft Corporation in the United States and other countries. All other trademarks and copyrights are the property of their respective owners.

# Table of Contents

<b>Introduction.....</b>	<b>1</b>	<b>Wireless Sharing.....</b>	<b>11</b>
Front View.....	1	Setting Up the Wi-Fi Network.....	11
Device Keys.....	2	Connecting Two ECHOMAP UHD2	
Connector View.....	2	Devices to Share User Data and	
Tips and Shortcuts.....	3	Sonar.....	11
Accessing Owner's Manuals on the		Connecting a Wireless Device to the	
Chartplotter.....	3	Chartplotter.....	12
Accessing the Manuals from the		Managing the Wi-Fi Network.....	12
Web.....	3		
Garmin Support Center.....	3	<b>Charts and 3D Chart Views.....</b>	<b>13</b>
Inserting Memory Cards.....	4	Detailed Charts.....	13
Acquiring GPS Satellite Signals.....	4	Activating a Marine Chart	
Selecting the GPS Source.....	4	Subscription.....	13
		Navigation Chart and Fishing Chart....	14
<b>Customizing the Chartplotter.....</b>	<b>5</b>	Chart Symbols.....	14
Home Screen.....	5	Zooming In and Out of the Chart.....	14
Rearranging the Category Items.....	5	Panning the Chart with the Keys.....	15
Customizing Pages.....	6	Selecting an Item on the Map Using	
Customizing the Startup Screen.....	6	the Device Keys.....	15
Customizing with Combination		Measuring a Distance on the	
Pages.....	6	Chart.....	15
Creating a New Combination Page....	7	Creating a Waypoint on the Chart....	15
Deleting a Combination Page.....	7	Viewing Location and Object	
Customizing the Data Overlays.....	7	Information on a Chart.....	15
Adjusting the Backlight.....	8	Viewing Details about Nav aids.....	15
Adjusting the Color Mode.....	8	Navigating to a Point on the Chart... 16	
Turning On the Chartplotter		Premium Charts.....	17
Automatically.....	8	Fish Eye 3D Chart View.....	17
Automatically Turning Off the		Viewing Tide Station Information....	18
System.....	8	Showing Satellite Imagery on the	
		Navigation Chart.....	19
<b>ActiveCaptain® App.....</b>	<b>8</b>	Viewing Aerial Photos of	
ActiveCaptain Roles.....	8	Landmarks.....	19
Getting Started with the ActiveCaptain		Chart Menu.....	19
App.....	9	Chart Layers.....	20
Updating Software with the		Chart Settings.....	22
ActiveCaptain App.....	9	Fish Eye 3D Settings.....	22
Updating Charts with ActiveCaptain....	10	Supported Maps.....	22
Chart Subscriptions.....	10		
Purchasing a Chart Subscription with		<b>Garmin Quickdraw Contours</b>	
ActiveCaptain.....	10	<b>Mapping.....</b>	<b>23</b>
Activating the Chart Subscription		Mapping a Body of Water Using the	
Card.....	10	Garmin Quickdraw Contours Feature..	23
Renewing Your Subscription.....	11	Adding a Label to a Garmin Quickdraw	
		Contours Map.....	23
		Garmin Quickdraw Community.....	24

Connecting to the Garmin Quickdraw Community with ActiveCaptain.....	24
Connecting to the Garmin Quickdraw Community with Garmin Connect....	24
Garmin Quickdraw Contours Settings.....	26

## **Navigation with a Chartplotter..... 26**

Basic Navigation Questions.....	27
Route Color Coding.....	27
Destinations.....	27
Searching for a Destination by Name.....	28
Selecting a Destination Using the Navigation Chart.....	28
Searching for a Marine Services Destination.....	28
Setting and Following a Direct Course Using Go To.....	28
Stopping Navigation.....	28
Waypoints.....	29
Marking Your Present Location as a Waypoint.....	29
Creating a Waypoint at a Different Location.....	29
Marking an MOB Location.....	29
Projecting a Waypoint.....	29
Viewing a List of all Waypoints.....	29
Editing a Saved Waypoint.....	29
Moving a Saved Waypoint.....	30
Browsing for and Navigating to a Saved Waypoint.....	30
Deleting a Waypoint or an MOB.....	30
Deleting All Waypoints.....	30
Routes.....	31
Creating and Navigating a Route From Your Present Location.....	31
Creating and Saving a Route.....	31
Viewing a List of Routes and Auto Guidance Paths.....	31
Editing a Saved Route.....	31
Finding and Navigating a Saved Route.....	32
Browsing for and Navigating Parallel to a Saved Route.....	32
Initiating a Search Pattern.....	33
Deleting a Saved Route.....	33
Deleting All Saved Routes.....	33

Auto Guidance.....	33
Setting and Following an Auto Guidance Path.....	33
Creating and Saving an Auto Guidance Path.....	34
Adjusting a Saved Auto Guidance Path.....	34
Canceling an Auto Guidance Calculation in Progress.....	34
Setting a Timed Arrival.....	34
Auto Guidance Path Configurations.....	35
Tracks.....	36
Showing Tracks.....	36
Setting the Color of the Active Track.....	37
Saving the Active Track.....	37
Viewing a List of Saved Tracks.....	37
Editing a Saved Track.....	37
Saving a Track as a Route.....	37
Browsing for and Navigating a Recorded Track.....	37
Deleting a Saved Track.....	37
Deleting All Saved Tracks.....	37
Retracing the Active Track.....	38
Clearing the Active Track.....	38
Managing the Track Log Memory During Recording.....	38
Configuring the Recording Interval of the Track Log.....	38
Boundaries.....	38
Creating a Boundary.....	38
Converting a Route to a Boundary... ..	39
Converting a Track to a Boundary... ..	39
Editing a Boundary.....	39
Setting a Boundary Alarm.....	39
Disabling all Boundary Alarms.....	39
Deleting a Boundary.....	39
Deleting All Saved Waypoints, Tracks, Routes, and Boundaries.....	39

## **Sonar Fishfinder..... 40**

Stopping the Transmission of Sonar Signals.....	40
Traditional Sonar View.....	40
Split-Frequency Sonar View.....	40
Split-Zoom Sonar View.....	40
Garmin ClearVü Sonar View.....	41

Flasher View.....	42	Viewing Trip Gauges.....	56
Selecting the Transducer Type.....	43	Resetting Trip Gauges.....	57
Selecting a Sonar Source.....	43	Viewing Graphs.....	57
Renaming a Sonar Source.....	43	Setting the Graph Range and Time	
Creating a Waypoint on the Sonar		Scales.....	57
Screen.....	43	<b>Warning Manager.....</b>	<b>57</b>
Pausing the Sonar Display.....	43	Viewing Messages.....	57
Viewing Sonar History.....	44	Sorting and Filtering Messages.....	57
Adjusting the Level of Detail.....	44	Saving Messages to a Memory Card...	57
Adjusting the Color Intensity.....	44	Clearing All of the Messages.....	58
Sonar Setup.....	45	<b>Device Configuration.....</b>	<b>58</b>
Setting the Zoom Level on the Sonar		System Settings.....	58
Screen.....	45	Sounds and Display Settings.....	58
Setting the Scroll Speed.....	46	Satellite Positioning (GPS)	
Adjusting the Range.....	46	Settings.....	58
Sonar Noise Rejection Settings.....	47	Viewing System Software	
Sonar Appearance Settings.....	47	Information.....	58
Sonar Alarms.....	48	Viewing E-label Regulatory and	
Advanced Sonar Settings.....	48	Compliance Information.....	59
Transducer Installation Settings.....	48	Preferences Settings.....	59
Sonar Frequencies.....	49	Units Settings.....	59
Turning On the A-Scope.....	50	Navigation Settings.....	59
<b>Sailing Features.....</b>	<b>50</b>	Communications Settings.....	62
Setting the Vessel Type for Sailing		Viewing Connected Devices.....	62
Features.....	50	Setting Alarms.....	62
Sail Racing.....	50	Navigation Alarms.....	62
Starting Line Guidance.....	51	System Alarms.....	63
Starting the Race Timer.....	51	Sonar Alarms.....	63
Stopping the Race Timer.....	51	My Vessel Settings.....	63
Setting the Distance between the Bow		Setting the Keel Offset.....	64
and the GPS Antenna.....	52	Setting the Water Temperature	
Laylines Settings.....	52	Offset.....	64
Polar Tables.....	52	Restoring the Original Chartplotter	
Importing a Polar Table Manually....	53	Factory Settings.....	65
Showing Polar Data in Data Fields...	53	<b>Sharing and Managing User Data....</b>	<b>65</b>
Setting the Keel Offset.....	54	Selecting a File Type for Third-Party	
Heading Line and Angle Markers.....	54	Waypoints and Routes.....	65
Setting the Heading Line and Angle		Copying User Data from a Memory	
Markers.....	55	Card.....	65
Viewing Sailing Vessel Data.....	55	Copying All User Data to a Memory	
<b>Gauges and Graphs.....</b>	<b>55</b>	Card.....	66
Viewing the Gauges.....	56	Copying User Data from a Specified Area	
Changing the Data Shown in a		to a Memory Card.....	66
Gauge.....	56	Updating Built-In Maps with a Memory	
Customizing the Gauges.....	56	Card and Garmin Express.....	66

Backing Up Data to a Computer.....	67
Restoring Backup Data to a Chartplotter.....	67
Saving System Information to a Memory Card.....	67

**Appendix..... 68**

ActiveCaptain and Garmin Express.....	68
Garmin Express App.....	68
Installing the Garmin Express App on a Computer.....	68
Registering Your Device Using the Garmin Express App.....	69
Updating Your Charts Using the Garmin Express App.....	70
Software Updates.....	70
Cleaning the Screen.....	71
Viewing Images on a Memory card.....	72
Screenshots.....	72
Capturing Screenshots.....	72
Copying Screenshots to a Computer.....	72
Troubleshooting.....	72
My device will not acquire GPS signals.....	72
My device will not turn on or keeps turning off.....	73
My device is not creating waypoints in the correct location.....	73
Contacting Garmin Support.....	73
Specifications.....	74
Specifications.....	74

# Introduction

## ⚠ WARNING

See the *Important Safety and Product Information* guide in the product box for product warnings and other important information.

All route and navigation lines displayed on the chartplotter are only intended to provide general route guidance or to identify proper channels, and are not intended to be precisely followed. Always defer to the nav aids and conditions on the water when navigating to avoid groundings or hazards that could result in vessel damage, personal injury, or death.

**NOTE:** Not all features are available on all models.

The Garmin® website at [support.garmin.com](http://support.garmin.com) presents up-to-date information about your product. The support pages will provide answers to frequently asked support questions, and you can download software and chart updates. There is also contact information to Garmin support should you have any questions.

## Front View



①

Power key





②

Device keys

③

microSD® memory card slot

## Device Keys

	Turns on and off the device when held. Opens a shortcut menu when quickly pressed and released. Scrolls through the brightness levels when pressed repeatedly.
	Zooms out.
	Zooms in.
HOME	Opens the Home screen. Takes a screenshot when held <sup>1</sup>
MENU	Opens a menu of options for the page, when applicable.
	Scrolls, highlights options, and moves the cursor.
SELECT	Selects the highlighted option.
BACK	Returns to the previous screen.
MARK	Saves the present location as a waypoint. Marks a MOB (Man Overboard) location when held.

## Connector View

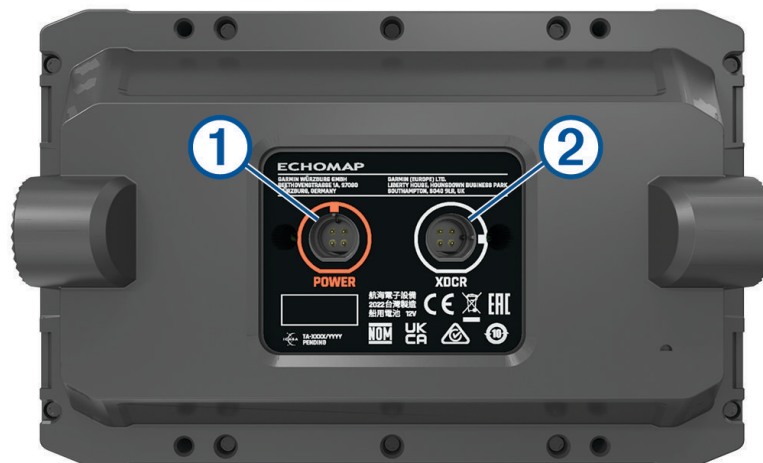









<b>①</b>	POWER	Power cable port
<b>②</b>	XDCR	4-pin transducer cable port

<sup>1</sup> This feature requires a microSD memory card ([Inserting Memory Cards](#), page 4).



## Tips and Shortcuts

- Press  to turn on the chartplotter.
- From any screen, press  repeatedly to scroll through the brightness levels, if available. This can be helpful when the brightness is so low you cannot see the screen.
- Select **HOME** from any screen to open to the home screen.
- Select **MENU** to open additional settings about that screen.
- Select **BACK** when finished with a menu, if necessary.
- Press  to open additional options, such as adjusting the backlight.
- Press , and select **Power > Turn Off System**, or hold  until the **Turn Off System** bar fills to turn off the chartplotter, when available.
- Press , and select **Power > Sleep Station** to set the chartplotter to standby mode, when available. To exit standby mode, select .
- If arrows indicate not all options are visible, press the indicated arrow key to view the additional options.
- On some menu buttons, select the button  to enable the option.

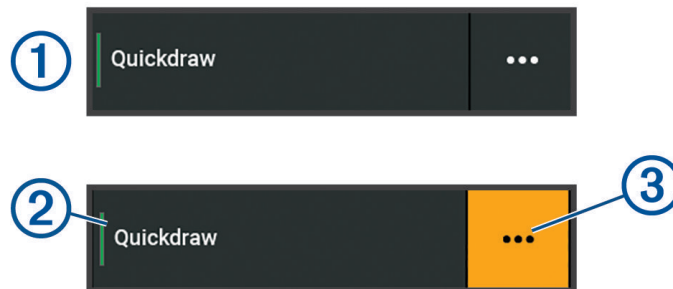

A green light on an option indicates the option is enabled .

- When available, select   to open the menu.

## Accessing Owner's Manuals on the Chartplotter

- 1 Select  > **Owner's Manual**.
- 2 Select a manual.
- 3 Select **Open**.

## Accessing the Manuals from the Web

You can get the latest owner's manual and translations of manuals from the Garmin website.

- 1 Go to [garmin.com/manuals/echomapUHD2](https://garmin.com/manuals/echomapUHD2).
- 2 Select the *Owner's Manual*.

A web manual opens. You can download the entire manual by selecting Download PDF.

## Garmin Support Center

Go to [support.garmin.com](https://support.garmin.com) for help and information, such as product manuals, frequently asked questions, videos, software updates, and customer support.

## Inserting Memory Cards

This device supports up to a 32 GB microSD memory card, formatted to FAT32 with speed class 4 or higher. Use of an 8 GB or larger memory card with speed class 10 is recommended.

- 1 Open the access flap or door ① on the front of the chartplotter.



- 2 Fully insert the memory card ②.
- 3 Clean and dry the gasket and door.

### NOTICE

To prevent corrosion, be sure the memory card, gasket, and door are thoroughly dry before closing the door.

- 4 Close the door.

## Acquiring GPS Satellite Signals

The device may need a clear view of the sky to acquire satellite signals. The time and date are set automatically based on the GPS position.

- 1 Turn on the device.
- 2 Wait while the device locates satellites.

It may take 30 to 60 seconds to acquire satellite signals.

To view the GPS satellite signal strength, select  > **System** > **Satellite Positioning**.

If the device loses satellite signals, a flashing question mark appears over the boat position indicator  on the chart.

For more information about GPS, go to [garmin.com/aboutGPS](http://garmin.com/aboutGPS). For help acquiring satellite signals, see [My device will not acquire GPS signals, page 72](#).

## Selecting the GPS Source

You can select your preferred source for GPS data, if you have more than one GPS source.

- 1 Select  > **System** > **Satellite Positioning** > **Source**.
- 2 Select the source for GPS data.

# Customizing the Chartplotter

## Home Screen

The home screen is an overlay that provides access to all of the features in the chartplotter. The features are dependent on the accessories you have connected to the chartplotter. You may not have all of the options and features discussed in this manual.

When viewing any screen, you can return to the home screen by selecting HOME.

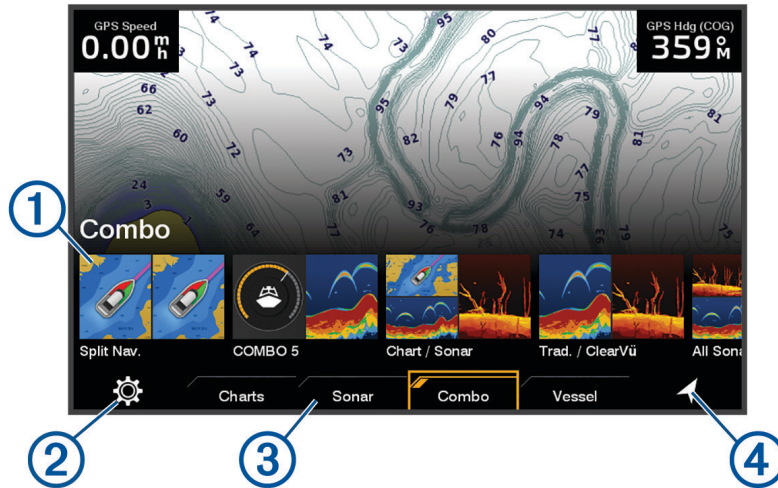

①	Features buttons
②	Settings menu button
③	Category tabs
④	Navigation information button

The categories tabs provide quick access to the main features of your chartplotter. For example, the Sonar tab displays the views and screens related to the sonar feature.

**TIP:** To view the available categories tabs, you may need to use the arrow keys to scroll left or right.

## Rearranging the Category Items

You can customize the screen by rearranging the items in the categories.

- 1 Select a category to customize, such as **Charts**
- 2 Highlight a feature button, such as **Nav. Chart**.
- 3 Press and hold the **SELECT** button.
- 4 Select **Rearrange**.  
Arrows appear on the feature buttons.
- 5 Reselect the button to move.
- 6 Use the arrow keys to highlight the new location and deselect.
- 7 Select the new location for the button.
- 8 Repeat until you finish customizing the screen.
- 9 Select **BACK** or **Home** when finished.

# Customizing Pages

## Customizing the Startup Screen

You can personalize the image that is displayed when the chartplotter is turning on. For the best fit, the image should be 50 MB or less and conform to the recommended dimensions ([Recommended Startup Image Dimensions, page 6](#)).

- 1 Insert a memory card that contains the image you want to use.
- 2 Select  > **System** > **Sounds and Display** > **Startup Image** > **Select Image**.
- 3 Select the memory card slot.
- 4 Select the image.
- 5 Select **Set as Startup Image**.

The new image is shown when turning on the chartplotter.

## Recommended Startup Image Dimensions

For the best fit for the startup images, use an image that has the following dimensions, in pixels.

Display resolution	Image width	Image height
WVGA	680	200
WSVGA	880	270

## Customizing with Combination Pages

You can customize the layout and data shown in the combination pages.

- 1 Select **Combo**.
- 2 Select a combo page to customize.
- 3 Select **MENU** > **Edit Combo**.
- 4 Select an option:
  - To change the name of a combo, select **Name**, and enter a new name.
  - To change the layout and number of functions shown, select **Layout**, and select an option.
  - To change the function of a portion of the screen, use the arrow keys to highlight the window to change, select it, and select a function.
  - To change how the screens are split, select a combo page, select **Resize Layout** and use the arrow keys to adjust the size.
  - To change the data shown on the page and additional data bars, select **Overlays**, and select an option.
- 5 Select **Done**.

## Creating a New Combination Page

You can create a custom combination page to suit your needs.

- 1 Select **Combo > Add Combo**.
- 2 Select a window.
- 3 Select a function for the window.
- 4 Repeat these steps for each window of the page.
- 5 Select **Layout**, and select a layout.

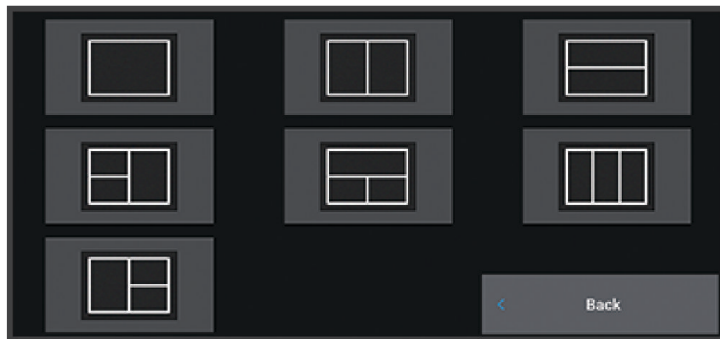

- 6 Select **Name**, enter a name for the page, and select **Done**.
- 7 Select **Overlays**, and select which data to show.
- 8 Select **Done** when you have finished customizing the page.

## Deleting a Combination Page

- 1 Select **Combo**.
- 2 Highlight a combination page to delete.
- 3 Select **MENU**.
- 4 Select **Delete Combo > Yes**.

## Customizing the Data Overlays

You can customize the data in the data overlays shown on a screen.

- 1 Select an option based on the type of screen you are viewing:
  - From a full screen view, select **MENU > Edit Overlays**.
  - From a combination screen, select **MENU > Edit Combo > Overlays**.
- 2 Select an item to customize the data and data bar:
  - To show the data overlays, select **Data**, select the location, and select **BACK**.
  - To change the data shown in an overlay box, select the overlay box, select the new data to show, and select **BACK**.
  - To customize the information shown when navigating, select **Navigation**, and select an option.
  - To turn on other data bars, select **Top Bar** or **Bottom Bar**, and select the necessary options.
- 3 Select **Done**.



## Adjusting the Backlight

1 Select  > **System** > **Sounds and Display** > **Backlight**.

2 Adjust the backlight.

**TIP:** From any screen, press  repeatedly to scroll through the brightness levels. This can be helpful when the brightness is so low you cannot see the screen.

## Adjusting the Color Mode

1 Select  > **System** > **Sounds and Display** > **Color Mode**.



**TIP:** Select  > **Color Mode** from any screen to access the color settings.

2 Select an option.

## Turning On the Chartplotter Automatically

You can set the chartplotter to turn on automatically when the power is applied. Otherwise, you must turn on the chartplotter by pressing .

Select  > **System** > **Auto Power Up**.

**NOTE:** When Auto Power Up is On, and the chartplotter is turned off using , and power is removed and reapplied within less than two minutes, you may need to press  to restart the chartplotter.

## Automatically Turning Off the System

You can set the chartplotter and the whole system to turn off automatically after it has been asleep for the selected length of time. Otherwise, you must press and hold  to turn off the system manually.

1 Select  > **System** > **Auto Power Off**.

2 Select an option.

# ActiveCaptain® App

### **WARNING**

This feature allows users to submit information. Garmin makes no representations about the accuracy, completeness, or timeliness of information submitted by users. Any use or reliance on the information submitted by users is at your own risk.

The ActiveCaptain app provides a connection to your ECHOMAP UHD2 chartplotter, maps and charts, and the ActiveCaptain community for a connected boating experience.

On your mobile device with the ActiveCaptain app, you can download, purchase, and update maps and charts. You can use the app to easily and quickly transfer user data, such as waypoints and routes, connect to the Garmin Quickdraw™ Contours Community, update device software, and plan your trip.

## ActiveCaptain Roles

Your level of interaction with the ECHOMAP UHD2 device using the ActiveCaptain app depends on your role.

Feature	Owner	Guest
Register device, built-in maps, and supplemental map cards to account	Yes	No
Update software	Yes	Yes
Automatically transfer Garmin Quickdraw contours you have downloaded or created	Yes	No
Automatically transfer user data, such as waypoints and routes	Yes	No
Begin navigating to a specific waypoint or navigating a specific route, and send that waypoint or route to the ECHOMAP UHD2 device	Yes	Yes

## Getting Started with the ActiveCaptain App

You can connect a mobile device to the ECHOMAP UHD2 device using the ActiveCaptain app. The app provides a quick and easy way for you to interact with your ECHOMAP UHD2 device and complete such tasks as sharing data, registering, updating the device software.

- 1 From the ECHOMAP UHD2 device, select **Vessel > ActiveCaptain**.
- 2 From the **ActiveCaptain** page, select **Wi-Fi Network > Wi-Fi > On**.
- 3 Enter a name and password for this network.
- 4 Insert a memory card in the ECHOMAP UHD2 device's card slot (*Inserting Memory Cards, page 4*).
- 5 Select **Set ActiveCaptain Card**.

### NOTICE

You might be prompted to format the memory card. Formatting the card deletes all information saved on the card. This includes any saved user data, such as waypoints. Formatting the card is recommended, but not required. Before formatting the card, you should save the data from the memory card onto the device internal memory (*Copying User Data from a Memory Card, page 65*). After formatting the card for the ActiveCaptain app, you can transfer the user data back to the card (*Copying All User Data to a Memory Card, page 66*).

Be sure the card is inserted each time you want to use the ActiveCaptain feature.

- 6 From the application store on your mobile device, install and open the ActiveCaptain app.
- 7 Bring the mobile device within 32 m (105 ft.) of the ECHOMAP UHD2 device.
- 8 From your mobile device settings, open the Wi-Fi® connections page, and connect to the ECHOMAP UHD2 device, using the name and password you entered in step 3.

## Updating Software with the ActiveCaptain App

If your device has Wi-Fi technology, you can use the ActiveCaptain app to download and install the latest software updates for your device.

### NOTICE

Software updates may require the app to download large files. Regular data limits or charges from your Internet service provider apply. Contact your Internet service provider for more information about data limits or charges.

The installation process can take several minutes.

- 1 Connect the mobile device to the ECHOMAP UHD2 device (*Getting Started with the ActiveCaptain App, page 9*).
- 2 When a software update is available and you have internet access on your mobile device, select **Software Updates > Download**.  
The ActiveCaptain app downloads the update to the mobile device. When you reconnect the app to the ECHOMAP UHD2 device, the update is transferred to the device. After the transfer is complete, you are prompted to install the update.
- 3 When you are prompted by the ECHOMAP UHD2 device, select an option to install the update.
  - To update the software immediately, select **OK**.
  - To delay the update, select **Cancel**. When you are ready to install the update, select **ActiveCaptain > Software Updates > Install Now**.



## Updating Charts with ActiveCaptain

**NOTE:** Before you can update your charts, you must register them (*Getting Started with the ActiveCaptain App*, page 9).

You can use the ActiveCaptain app to download and transfer the latest chart updates for your device. To shorten download time and conserve storage space, you can download only the areas of the chart you need.

After you download a chart or area for the first time, updates are automatic each time you open ActiveCaptain.

If you are downloading an entire chart, you can use the Garmin Express™ app to download the map onto a memory card (*Updating Your Charts Using the Garmin Express App*, page 70). The Garmin Express app downloads large charts more quickly than the ActiveCaptain app.

### NOTICE

Chart updates may require the app to download large files. Regular data limits or charges from your internet service provider apply. Contact your internet service provider for more information about data limits or charges.

1 When you have internet access on your mobile device, select **Chart** >  > **Download Charts**.

2 Select the area to download.

3 Select **Download**.

4 If necessary, select the map to update.

The ActiveCaptain app downloads the update to the mobile device. When you reconnect the app to the ECHOMAP UHD2 device, the update is transferred to that device. After the transfer is complete, the updated charts are available for use.

## Chart Subscriptions

A chart subscription allows you to access the latest chart updates and additional content using the ActiveCaptain mobile app or the Garmin Express desktop app. You can download updated charts and content each day.

You can purchase chart subscriptions in a variety of ways.

- Digital purchase in the ActiveCaptain mobile app
- Digital purchase on [garmin.com](http://garmin.com)
- Physical chart card purchase at a retail location or through [garmin.com](http://garmin.com) or [navionics.com](http://navionics.com)
- Physical chart upgrade card purchase at a retail location (for upgrading the built-in charts)

### Purchasing a Chart Subscription with ActiveCaptain

1 Connect your mobile device to the internet and open the ActiveCaptain app.

2 Select **Chart** >  > **My Charts** > **Add a Chart Subscription**.

3 Select a chart.

4 Select **Subscribe Now**.

**NOTE:** It might take a few hours to display the new subscription.

### Activating the Chart Subscription Card

To use the ActiveCaptain app to activate your subscription, you must have internet access.

1 Insert the purchased chart subscription card into a memory card slot on the chartplotter.

2 Connect your mobile device to the chartplotter (*Getting Started with the ActiveCaptain App*, page 9).

3 Disconnect your mobile device from the chartplotter and connect it to the internet.

ActiveCaptain activates the subscription.

4 After you see the new subscription in the ActiveCaptain list, disconnect your mobile device from the internet, and connect it to the chartplotter to complete the activation process.

**NOTE:** It might take a few hours to display the new subscription. Wait time may vary depending on location and internet speed.



## Renewing Your Subscription

Your cartography subscription expires after one year. After the subscription expires, you can continue using the downloaded charts, but you are not able to download the latest chart updates or additional content.

- 1 Connect your mobile device to the internet and open the ActiveCaptain app.
- 2 Select **Chart** >  > **My Charts**.
- 3 Select the chart to renew.
- 4 Select **Renew Now**.

**NOTE:** It might take a few hours to display the renewed subscription.

## Wireless Sharing

You can connect two ECHOMAP UHD2 devices wirelessly to share user data and sonar ([Connecting Two ECHOMAP UHD2 Devices to Share User Data and Sonar, page 11](#)). The first time you open the wireless network settings, you are prompted to set up the wireless network on the host device. After you set up the network, you can also connect the device to other wireless devices, such as your phone, to use the ActiveCaptain app ([Getting Started with the ActiveCaptain App, page 9](#)).

### Setting Up the Wi-Fi Network

This device can host a Wi-Fi network to which you can connect wireless devices such as another chartplotter or your phone. The first time you access the wireless network settings, you are prompted to set up the network.

- 1 Select  > **Communications** > **Wi-Fi Network** > **Wi-Fi** > **On** > **OK**.
- 2 If necessary, enter a name for this wireless network.
- 3 Enter a password.

You will need this password to access the wireless network from a wireless device, such as your phone. The password is case-sensitive.



### Connecting Two ECHOMAP UHD2 Devices to Share User Data and Sonar

You can connect two ECHOMAP UHD2 devices to share user data and sonar wirelessly.

User data is shared automatically between the two devices while they are connected. Sonar sharing may require you to select a sonar source ([Sonar Sharing, page 12](#)).

To connect the two devices, you must designate one device as the host and the other device as the client. You can only connect two ECHOMAP UHD2 devices at a time. The host device can be connected to other wireless devices like your phone or tablet while it is connected with a ECHOMAP UHD2 device.

**NOTE:** A ECHOMAP UHD2 6/7/9 sv device cannot connect to a ECHOMAP UHD2 5/7 cv set as the host device. You must set up the ECHOMAP UHD2 6/7/9 sv device as the host in this situation.

- 1 Ensure the two ECHOMAP UHD2 devices are within range, 32 m (105 ft.), and turn on both devices.
- 2 On the ECHOMAP UHD2 that will host the network, set up the Wi-Fi network ([Setting Up the Wi-Fi Network, page 11](#)).
- 3 On the ECHOMAP UHD2 host device, select  > **Communications** > **Wi-Fi Network** > **Wi-Fi** > **On** > **Host** > **Pair Chartplotter** > **Start**.
- 4 On the ECHOMAP UHD2 client device, select  > **Communications** > **Wi-Fi Network** > **Wi-Fi** > **On** > **Client** > **Pair Host** > **Start**.
- 5 Select **OK** after devices connect successfully.

To unpair the devices and remove the wireless credentials so they do not attempt to connect in the future, on the client device select  > **Communications** > **Wi-Fi Network** > **Unpair**.

If you cannot connect the two devices, troubleshoot the connection and try again ([Troubleshooting the Wireless Connection, page 12](#)).

## Sonar Sharing

Two ECHOMAP UHD2 devices connected over the Wi-Fi network can share sonar ([Connecting Two ECHOMAP UHD2 Devices to Share User Data and Sonar, page 11](#)).

If both of the ECHOMAP UHD2 devices have a transducer connected, each device uses its own sonar source automatically. You can switch the sonar source manually to the other device ([Selecting a Sonar Source, page 43](#)).

If only one ECHOMAP UHD2 device has a transducer connected, that device is the sonar source for both devices.

## Troubleshooting the Wireless Connection

If you cannot connect two ECHOMAP UHD2 devices, check the following items and try again.

- If you are connecting a ECHOMAP UHD2 6/7/9 sv device and a ECHOMAP UHD2 5/7 cv device, you must set up the ECHOMAP UHD2 6/7/9 sv as the network host. A ECHOMAP UHD2 6/7/9 sv device cannot connect to a ECHOMAP UHD2 5/7 cv device set up as the host.
- Ensure the two devices are within range (32 m (105 ft.)).
- Check for signal obstructions between the devices, especially metal.
- Turn the devices off and on again, and try to connect again.

## Connecting a Wireless Device to the Chartplotter

Before you can connect a wireless device to the chartplotter wireless network, you must configure the chartplotter wireless network ([Setting Up the Wi-Fi Network, page 11](#)).

You can connect multiple wireless devices to the chartplotter to share data.

- 1 From the wireless device, turn on the Wi-Fi technology and search for wireless networks.
- 2 Select the name of your chartplotter wireless network ([Setting Up the Wi-Fi Network, page 11](#)).
- 3 Enter the chartplotter password.

## Managing the Wi-Fi Network

### Changing the Wi-Fi Host

If there are multiple chartplotters with Wi-Fi technology on the Garmin marine network, you can change which chartplotter is the Wi-Fi host. This can be helpful if you are having trouble with Wi-Fi communications. Changing the Wi-Fi host allows you to select a chartplotter that is physically closer to your mobile device.

- 1 Select  > **Communications** > **Wi-Fi Network** > **Advanced** > **Wi-Fi Host**.
- 2 Follow the on-screen instructions.

### Changing the Wireless Channel

You can change the wireless channel if you have trouble finding or connecting to a device, or if you experience interference.

- 1 Select  > **Communications** > **Wi-Fi Network** > **Advanced** > **Channel**.
- 2 Enter a new channel.

You do not need to change the wireless channel of devices connected to this network.

## Charts and 3D Chart Views

The charts and 3D chart views that are available depend on the map data and accessories used.

**NOTE:** 3D chart views are available with premium charts, in some areas.

You can access the charts and 3D chart views by selecting Charts.

**Nav. Chart:** Shows navigation data available on your pre-loaded maps and from supplemental maps, if available. The data includes buoys, lights, cables, depth soundings, marinas, and tide stations in an overhead view.

**Fishing Chart:** Provides a detailed view of the bottom contours and depth soundings on the chart. This chart removes navigational data from the chart, provides detailed bathymetric data, and enhances bottom contours for depth recognition. This chart is best for offshore deep-sea fishing.

**NOTE:** The Fishing chart is available with premium charts, in some areas.

**Perspective 3D:** Provides a view from above and behind the boat (according to your course) and provides a visual navigation aid. This view is helpful when navigating tricky shoals, reefs, bridges, or channels, and is beneficial when trying to identify entry and exit routes in unfamiliar harbors or anchorages.

**3D Chart:** Shows a detailed, three-dimensional view from above and behind the boat (according to your course) and provides a visual navigation aid. This view is helpful when navigating tricky shoals, reefs, bridges, or channels, and when trying to identify entry and exit routes in unfamiliar harbors or anchorages.

**Fish Eye 3D:** Provides an underwater view that visually represents the sea floor according to the chart information. When a sonar transducer is connected, suspended targets (such as fish) are indicated by red, green, and yellow spheres. Red indicates the largest targets and green indicates the smallest.

**Relief Shading:** Provides high resolution elevation shading of lakes and coastal waters. This chart can be helpful for fishing and diving.

**NOTE:** The Relief Shading chart is available with premium charts, in some areas.

### Detailed Charts

This chartplotter is compatible with the latest Garmin Navionics+™ cartography and additional premium chart features. You can obtain these charts in three ways:

- You can purchase a chartplotter with preloaded detailed charts.
- You can purchase chart regions on a memory card from your Garmin dealer or from [garmin.com](http://garmin.com).
- You can purchase chart regions in the ActiveCaptain app, and download them to your chartplotter.

**NOTE:** You must activate preloaded charts and charts purchased on a memory card using the ActiveCaptain app before you can access the full chart features on your chartplotter.

### Activating a Marine Chart Subscription

Before you can use the full features of Garmin Navionics+ charts that are preloaded on your device or purchased on a memory card, you must activate your subscription using the ActiveCaptain app.

Your subscription allows you to access the latest chart updates and additional content included with your purchase.

- 1 If you purchased charts on a memory card, insert the card into a memory card slot on the chartplotter or Garmin memory card reader.
- 2 Open the ActiveCaptain app on your mobile device, and connect it to the chartplotter (*Getting Started with the ActiveCaptain App*, page 9).
- 3 After the ActiveCaptain app connects to the chartplotter, make sure your mobile device is connected to the internet.
- 4 In the ActiveCaptain app, select **Chart** >  > **My Charts**, and verify that an active subscription for the charts is shown in the list.
- 5 If necessary, connect the ActiveCaptain app to the chartplotter to complete the activation process.

The ActiveCaptain app activates the subscription automatically after it connects to the internet and then to the chartplotter. The ActiveCaptain app shows the subscription status in the My Charts list.

**NOTE:** It might take a few hours to verify the new subscription.

## Navigation Chart and Fishing Chart

**NOTE:** The Fishing chart is available with premium charts, in some areas.



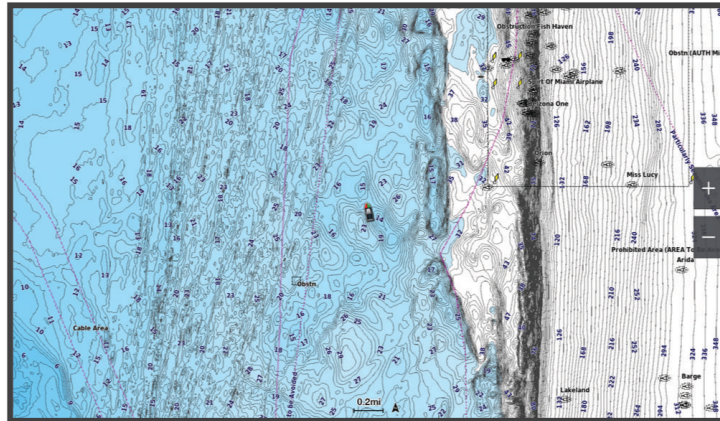



The Nav. Chart is optimized for navigation. You can plan a course, view map information, and use the chart as a navigational aid. To open the Nav. Chart, select **Charts > Nav. Chart**.



The Fishing Chart provides a detailed view with more bottom detail and fishing content. This chart is optimized for use when fishing. To open the Fishing Chart, select **Charts > Fishing Chart**.

### Chart Symbols

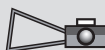

This table contains some of the common symbols you might see on the detailed charts.

Icon	Description
	Buoy
	Information
	Marine services
	Tide station
	Current station
	Overhead photo available
	Perspective photo available

Other features common to most charts include depth contour lines, intertidal zones, spot soundings (as depicted on the original paper chart), navigational aids and symbols, obstructions, and cable areas.

### Zooming In and Out of the Chart

The zoom level is indicated by the scale number at the bottom of the chart. The bar under the scale number represents that distance on the chart.

- To zoom out, select .
- To zoom in, select .

## Panning the Chart with the Keys

You can move the chart to view an area other than your present location.

- 1 From the chart, use the arrow keys.
- 2 Select **BACK** to stop panning and return the screen to your present location.

**NOTE:** To pan from a combination screen, select **SELECT**.

## Selecting an Item on the Map Using the Device Keys

- 1 From a chart or 3D chart view, select **←**, **→**, **↓**, or **↑** to move the cursor.
- 2 Select **SELECT**.

## Measuring a Distance on the Chart

- 1 From a chart, select a location.
- 2 Select **Measure**.

A push pin appears on the screen at your present location. The distance and angle from the pin is listed in the corner.

**TIP:** To reset the pin and measure from the current location of the cursor, select **Set Reference**.

## Creating a Waypoint on the Chart

- 1 From a chart, select a location or object.
- 2 Select **Create Waypoint**.

## Viewing Location and Object Information on a Chart

You can view information, such as tide, current, celestial, chart notes, or local services, about a location or an object on the Navigation chart or the Fishing chart.

- 1 From the Navigation chart or Fishing chart, select a location or object.  
A list of options appears. The options that appear vary based on the location or object you selected.
- 2 Select **Information**.

## Viewing Details about Nav aids

From the Navigation chart, Fishing chart, Perspective 3D chart view, or Mariner's Eye 3D chart view, you can view details about various types of navigation aids, including beacons, lights, and obstructions.

**NOTE:** The Fishing chart is available with premium charts, in some areas.

**NOTE:** 3D chart views are available with premium charts, in some areas.

- 1 From a chart or 3D chart view, select a nav aid.
- 2 Select the name of the nav aid.

## Navigating to a Point on the Chart

### WARNING



All route and navigation lines displayed on the chartplotter are only intended to provide general route guidance or to identify proper channels, and are not intended to be precisely followed. Always defer to the nav aids and conditions on the water when navigating to avoid groundings or hazards that could result in vessel damage, personal injury, or death.

The Auto Guidance feature is based on electronic chart information. That data does not ensure obstacle and bottom clearance. Carefully compare the course to all visual sightings, and avoid any land, shallow water, or other obstacles that may be in your path.

When using Go To, a direct course and a corrected course may pass over land or shallow water. Use visual sightings, and steer to avoid land, shallow water, and other dangerous objects.

**NOTE:** The Fishing chart is available with premium charts, in some areas.

**NOTE:** Auto Guidance is available with premium charts, in some areas.

- 1 From the Navigation chart or Fishing chart, select a location.
- 2 If necessary, select **Navigate To**.
- 3 Select an option:
  - To navigate directly to the location, select **Go To** or .
  - To create a route to the location, including turns, select **Route To** or .
  - To use Auto Guidance, select **Auto Guidance** or .
- 4 Review the course indicated by the magenta line ([Route Color Coding](#), page 27).

**NOTE:** When using Auto Guidance, a gray segment within any part of the magenta line indicates that Auto Guidance cannot calculate part of the Auto Guidance line. This is due to the settings for minimum safe water depth and minimum safe obstacle height.

- 5 Follow the magenta line, steering to avoid land, shallow water, and other obstacles.

## Premium Charts

### ⚠ WARNING

All route and navigation lines displayed on the chartplotter are only intended to provide general route guidance or to identify proper channels, and are not intended to be precisely followed. Always defer to the nav aids and conditions on the water when navigating to avoid groundings or hazards that could result in vessel damage, personal injury, or death.

The Auto Guidance feature is based on electronic chart information. That data does not ensure obstacle and bottom clearance. Carefully compare the course to all visual sightings, and avoid any land, shallow water, or other obstacles that may be in your path.

**NOTE:** Not all models support all charts.

Optional premium charts, such as Garmin Navionics Vision+™, allow you to get the most out of your chartplotter. In addition to detailed marine charting, premium charts may contain these features, which are available in some areas.

**Mariner's Eye 3D:** Provides a view from above and behind the boat for a three-dimensional navigation aid.

**Fish Eye 3D:** Provides an underwater, three-dimensional view that visually represents the sea floor according to the information on the chart.

**Fishing Charts:** Shows the chart with enhanced bottom contours and without navigational data. This chart works well for offshore deep-sea fishing.

**High Resolution Satellite Imagery:** Provides high-resolution satellite images for a realistic view of the land and water on the Navigation chart ([Showing Satellite Imagery on the Navigation Chart, page 19](#)).

**Aerial Photos:** Shows marinas and other navigationally significant aerial photos to help you visualize your surroundings ([Viewing Aerial Photos of Landmarks, page 19](#)).

**Detailed Roads and POI data:** Shows detailed road and point of interest (POI) data, which includes highly detailed coastal roads and POIs such as restaurants, lodging, and local attractions.

**Auto Guidance:** Uses specified information about your vessel and chart data to determine the best path to your destination.

**Sonar Imagery:** Shows sonar imagery to help show the density of the bottom.

**Relief Shading:** Shows the gradient of the bottom with shading.

### Fish Eye 3D Chart View

Using the depth contour lines of the premium charts, such as Garmin Navionics Vision+, the Fish Eye 3D chart view provides an underwater view of the sea floor or lake bottom.

Suspended targets, such as fish, are indicated by red, green, and yellow spheres. Red indicates the largest targets and green indicates the smallest.

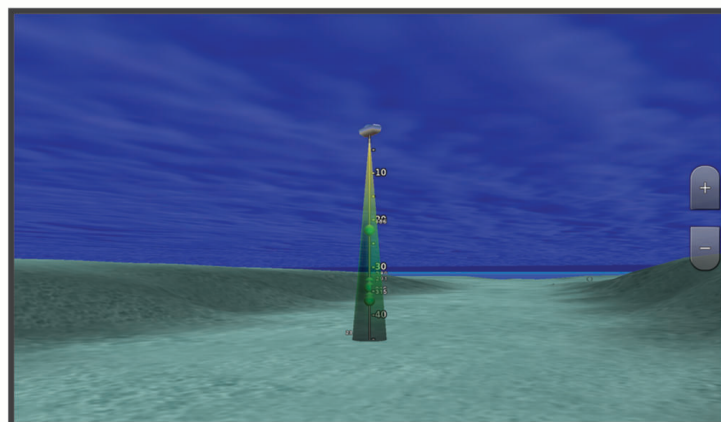



## Viewing Tide Station Information

### ⚠ WARNING

Tide and current information is for information purposes only. It is your responsibility to heed all posted water-related guidance, to remain aware of your surroundings, and to use safe judgment in, on, and around the water at all times. Failure to heed this warning could result in property damage, serious personal injury, or death.

The  icon on the chart indicates a tide station. You can view a detailed graph for a tide station to help predict the tide level at different times or on different days.

**NOTE:** This feature is available with premium charts, in some areas.

1 From the Navigation chart or Fishing chart, select a tide station.

Tide direction and tide level information appear near .

2 Select the station name.

## Animated Tide and Current Indicators

### ⚠ WARNING

Tide and current information is for information purposes only. It is your responsibility to heed all posted water-related guidance, to remain aware of your surroundings, and to use safe judgment in, on, and around the water at all times. Failure to heed this warning could result in property damage, serious personal injury, or death.

**NOTE:** This feature is available with premium charts, in some areas.

You can view indicators for animated tide station and current direction on the Navigation chart or the Fishing chart. You must also enable animated icons in the chart settings ([Showing Tides and Current Indicators](#), page 18).

An indicator for a tide station appears on the chart as a vertical bar graph with an arrow. A red arrow pointing downward indicates a falling tide, and a blue arrow pointing upward indicates a rising tide. When you move the cursor over the tide station indicator, the height of the tide at the station appears above the station indicator.

Current direction indicators appear as arrows on the chart. The direction of each arrow indicates the direction of the current at a specific location on the chart. The color of the current arrow indicates the range of speed for the current at that location. When you move the cursor over the current direction indicator, the specific current speed at the location appears above the direction indicator.

Color	Current Speed Range
Yellow	0 to 1 knot
Orange	1 to 2 knots
Red	2 or more knots

## Showing Tides and Current Indicators

**NOTE:** This feature is available with premium charts, in some areas.

You can show static or animated tide and current station indicators on the Navigation chart or Fishing chart.

1 From the Navigation or Fishing chart, select **MENU > Layers > Chart > Tides & Currents**.

2 Select an option:

- To show animated tide station indicators and animated current direction indicators on the chart, select **Animated**.
- To enable the tides and current slider, which sets the time for which tides and currents are reported on the map, select **Slider**.



## Showing Satellite Imagery on the Navigation Chart

**NOTE:** This feature is available with premium charts, in some areas.

You can overlay high-resolution satellite images on the land or on both land and sea portions of the Navigation chart.

**NOTE:** When enabled, high-resolution satellite images are present only at lower zoom levels. If you cannot see high-resolution images in your optional chart region, you can select  to zoom in. You also can set the detail level higher by changing the map zoom detail.

1 From the Navigation chart, select **MENU > Layers > Chart > Satellite Photos**.

2 Select an option:

- Select **Land Only** to show standard chart information on the water, with photos overlaying the land.

**NOTE:** This setting must be enabled to view Standard Mapping® charts.

- Select **Photo Map** to show photos on both the water and the land at a specified opacity. Use the slider bar to adjust the photo opacity. The higher you set the percentage, the more the satellite photos cover both land and water.



## Viewing Aerial Photos of Landmarks

Before you can view aerial photos on the Navigation chart, you must turn on the Photo Points setting in the chart setup ([Chart Layers, page 20](#)).

**NOTE:** This feature is available with premium charts, in some areas.

You can use aerial photographs of landmarks, marinas, and harbors to help orient yourself to your surroundings or to acquaint yourself with a marina or a harbor prior to arrival.

1 From the Navigation chart, select a camera icon:

- To view an overhead photo, select .
- To view a perspective photo, select . The photo was taken from the location of the camera, pointed in the direction of the cone.

2 Select **Photo**.

## Chart Menu

**NOTE:** Not all settings apply to all charts. Some options require premium maps or connected accessories, such as radar.

**NOTE:** The menus may contain some settings that are not supported by your installed charts or your present location. If you make changes to those settings, the changes will not impact the chart view.

From a chart, select **MENU**.

**Layers:** Adjusts the appearance of the different items on the charts ([Chart Layers, page 20](#)).

**Quickdraw Contours:** Turns on bottom contour drawing, and allows you to create fishing map labels ([Garmin Quickdraw Contours Mapping, page 23](#)).

**Settings:** Adjusts the chart settings ([Chart Settings, page 22](#)).

**Edit Overlays:** Adjusts the data shown on the screen ([Customizing the Data Overlays, page 7](#)).

## Chart Layers

You can turn on and off chart layers and customize features of the charts. Each setting is specific to the chart or chart view being used.

**NOTE:** Not all settings apply to all charts and chartplotter models. Some options require premium maps or connected accessories.

**NOTE:** The menus may contain some settings that are not supported by your installed charts or your present location. If you make changes to those settings, the changes will not impact the chart view.

From a chart, select **MENU > Layers**.

**Chart:** Shows and hides chart-related items ([Chart Layer Settings, page 20](#)).

**My Vessel:** Shows and hides items relating to the boat ([My Vessel Layer Settings, page 20](#)).

**Manage User Data:** Shows and hides user data, such as waypoints, boundaries, and tracks, and opens user data lists ([User Data Layer Settings, page 21](#)).

**Water:** Shows and hides depth items ([Water Layer Settings, page 21](#)).

**Quickdraw Contours:** Shows and hides Garmin Quickdraw Contours data ([Garmin Quickdraw Contours Settings, page 26](#)).

## Chart Layer Settings

From a chart, select **MENU > Layers > Chart**.

**Satellite Photos:** Shows high-resolution satellite images on the land or on both land and sea portions of the Navigation chart, when certain premium maps are used ([Showing Satellite Imagery on the Navigation Chart, page 19](#)).

**NOTE:** This setting must be enabled to view Standard Mapping charts.

**Tides & Currents:** Shows current station indicators and tide station indicators on the chart ([Showing Tides and Current Indicators, page 18](#)) and enables the tides and current slider, which sets the time for which tides and currents are reported on the map.

**Land POIs:** Shows points of interest on land.

**Navaid:** Shows navigational aids, such as ATONs and flashing lights, on the chart. Allows you to select NOAA or IALA navaid type.

**Service Points:** Shows locations for marine services.

**Depth:** Adjusts the items on the depth layer ([Depth Layer Settings, page 20](#)).

**Restricted Areas:** Shows information about restricted areas on the chart.

**Photo Points:** Shows camera icons for aerial photos ([Viewing Aerial Photos of Landmarks, page 19](#)).

## Depth Layer Settings

From a chart, select **MENU > Layers > Chart > Depth**.

**Depth Shading:** Specifies an upper and lower depth to shade between.

**Shallow Shading:** Sets the shades from the shoreline to the specified depth.

**Spot Depths:** Turns on spot soundings and sets a dangerous depth. Spot depths that are equal to or more shallow than the dangerous depth are indicated by red text.

**Fishing Contours:** Sets the zoom level for a detailed view of bottom contours and depth soundings and simplifies map presentation for optimal use while fishing.

## My Vessel Layer Settings

From a chart, select **MENU > Layers > My Vessel**.

**Heading Line:** Shows and adjusts the heading line, which is a line drawn on the map from the bow of the boat in the direction of travel.

**Active Tracks:** Shows the active track on the chart and opens the Active Track Options menu.

**Compass Rose:** Shows a compass rose around your boat, indicating compass direction oriented to the heading of the boat.

**Vessel Icon:** Sets the icon that represents your present location on the chart.

## User Data Layer Settings

You can show user data, such as waypoints, boundaries, and tracks, on the charts.

From a chart, select **MENU > Layers > Manage User Data**.

**Waypoints:** Shows waypoints on the chart and opens the list of waypoints.

**Boundaries:** Shows boundaries on the chart and opens the list of boundaries.

**Tracks:** Shows tracks on the chart.

## Water Layer Settings

From a chart, select **MENU > Layers > Water**.

**NOTE:** The menu may contain some settings that are not supported by your installed charts or your present location. If you make changes to those settings, the changes will not impact the chart view.

**NOTE:** Not all settings apply to all charts, views, and chartplotter models. Some options require premium maps or connected accessories.

**Depth Shading:** Specifies an upper and lower depth to shade between ([Depth Range Shading, page 21](#)).

**Shallow Shading:** Sets the shades from the shoreline to the specified depth.

**Spot Depths:** Turns on spot soundings and sets a dangerous depth. Spot depths that are equal to or more shallow than the dangerous depth are indicated by red text.

**Fishing Contours:** Sets the zoom level for a detailed view of bottom contours and depth soundings and simplifies map presentation for optimal use while fishing.

**Relief Shading:** Shows the gradient of the bottom with shading. This feature is available only with some premium maps.

**Sonar Imagery:** Shows sonar imagery to help show the density of the bottom. This feature is available only with some premium maps.

**Lake Level:** Sets the present water level of the lake. This feature is available only with some premium maps.

## Depth Range Shading

You can set color ranges on your map to show the water depths where your target fish are currently biting. You can set deeper ranges to monitor how quickly the bottom depth changes within a specific depth range. You can create up to ten depth ranges. For inland fishing, a maximum of five depth ranges can help reduce map clutter. The depth ranges apply to all charts and all bodies of water.

Some Garmin LakeVü™ and premium supplemental charts have multiple depth range shading by default.

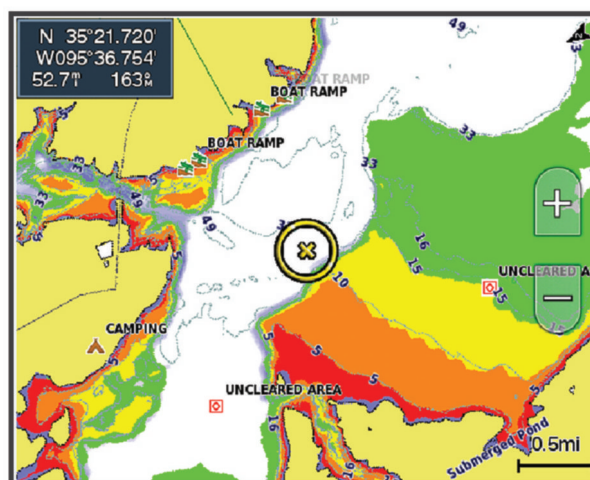

Red	From 0 to 1.5 m (from 0 to 5 ft.)
Orange	From 1.5 to 3 m (from 5 to 10 ft.)
Yellow	From 3 to 4.5 m (from 10 to 15 ft.)
Green	From 4.5 to 7.6 m (from 15 to 25 ft.)

To turn on and adjust, from a chart, select **MENU > Layers > Water > Depth Shading**.

## Chart Settings

**NOTE:** Not all settings apply to all charts and 3D chart views. Some settings require external accessories or applicable premium charts.

From a chart, select **MENU > Chart Settings**.

**Map Orientation:** Sets the perspective of the map.

**Look Ahead:** Shifts your present location toward the bottom of the screen automatically as your speed increases. Enter your top speed for the best results.

**Vessel Orientation:** Sets the alignment of the vessel icon on the map. The Auto option aligns the vessel icon using GPS COG at high speeds and the magnetic heading at low speeds to better align the vessel icon with the active track line. The Heading option aligns the vessel icon with the magnetic heading. The GPS Heading (COG) option aligns the vessel icon using GPS COG. If the selected data source is not available, the available data source is used instead.

### WARNING

The vessel orientation setting is for informational purposes and is not intended to be precisely followed. Always defer to the nav aids and conditions on the water to avoid groundings or hazards that could result in vessel damage, personal injury, or death.

**NOTE:** You can set the Map Orientation and Vessel Orientation settings separately for two navigation charts used in a combination page.

**Detail:** Adjusts the amount of detail shown on the map, at different zoom levels.

**Chart Size:** Sets the visible size of the chart.

**World Map:** Uses either a basic world map or a shaded relief map on the chart. These differences are visible only when zoomed out too far to see the detailed charts.

**Inset Map:** Shows a small map centered on your present location.

## Fish Eye 3D Settings

**NOTE:** This feature is available with premium charts, in some areas.

From the Fish Eye 3D chart view, select **MENU**.

**View:** Sets the perspective of the 3D chart view.

**Tracks:** Shows tracks.

**Sonar Cone:** Shows a cone that indicates the area covered by the transducer.

**Fish Symbols:** Shows suspended targets.

## Supported Maps

To help you have a safe and enjoyable time on the water, Garmin devices only support official maps produced by Garmin or an approved third party producer.

You can purchase maps from Garmin. If you purchase maps from a seller other than Garmin, investigate the seller before purchasing. Be extra cautious with online sellers. If you have purchased an unsupported map, return it to the seller.

# Garmin Quickdraw Contours Mapping

## WARNING

The Garmin Quickdraw Contours mapping feature allows users to generate maps. Garmin makes no representations about the accuracy, reliability, completeness or timeliness of the maps generated by third parties. Any use or reliance on the maps generated by third parties is at your own risk.

The Garmin Quickdraw Contours mapping feature allows you to instantly create maps with contours and depth labels for any body of water.

When Garmin Quickdraw Contours records data, a colored circle surrounds the vessel icon. This circle represents the approximate area of the map that is scanned by each pass.



A green circle indicates good depth and GPS position, and a speed under 16 km/h (10 mph). A yellow circle indicates good depth and GPS position, and a speed between 16 and 32 km/h (10 and 20 mph). A red circle indicates poor depth or GPS position, and a speed above 32 km/h (20 mph).

You can view Garmin Quickdraw Contours in a combination screen or as a single view on the map.

The amount of saved data depends on the size of your memory card, your sonar source, and the speed of your boat as you record data. You can record longer when you use a single-beam sonar. It is estimated that you might be able to record about 1,500 hours of data onto a 2 GB memory card.

When you record data on a memory card in your chartplotter, the new data is added to your existing Garmin Quickdraw Contours map, and is saved on the memory card. When you insert a new memory card, the existing data does not transfer onto the new card.

## Mapping a Body of Water Using the Garmin Quickdraw Contours Feature

Before you can use the Garmin Quickdraw Contours feature, you must have sonar depth, your GPS position, and a memory card with free space.

- 1 From a chart view, select **MENU > Quickdraw Contours > Start Recording**.
- 2 When recording is complete, select **MENU > Quickdraw Contours > Stop Recording**.
- 3 Select **Manage > Name**, and enter a name for the map.

## Adding a Label to a Garmin Quickdraw Contours Map

You can add labels to a Garmin Quickdraw Contours map to mark hazards or points of interest.

- 1 From the Navigation chart, select a location.
- 2 Select **Quickdraw Lbl.**
- 3 Enter text for the label, and select **Done**.

## Garmin Quickdraw Community

The Garmin Quickdraw Community is a free, public, online community that enables you to download maps other users have created. You can share your Garmin Quickdraw Contours maps with others.

If your device has Wi-Fi technology, you can use the ActiveCaptain app to access the Garmin Quickdraw Community (*Connecting to the Garmin Quickdraw Community with ActiveCaptain, page 24*).

If your device does not have Wi-Fi technology, you can use the Garmin Connect™ website to access the Garmin Quickdraw Community (*Connecting to the Garmin Quickdraw Community with Garmin Connect, page 24*).

### Connecting to the Garmin Quickdraw Community with ActiveCaptain

- 1 From your mobile device, open the ActiveCaptain app and connect to the ECHOMAP UHD2 device (*Getting Started with the ActiveCaptain App, page 9*).
- 2 From the app, select **Quickdraw Community**.

You can download contours from others in the community (*Downloading Garmin Quickdraw Community Maps Using ActiveCaptain, page 24*) and share the contours you have created (*Sharing Your Garmin Quickdraw Contours Maps with the Garmin Quickdraw Community Using ActiveCaptain, page 24*).

### Downloading Garmin Quickdraw Community Maps Using ActiveCaptain

You can download Garmin Quickdraw Contours maps that other users have created and shared with the Garmin Quickdraw Community.

- 1 From the ActiveCaptain app on your mobile device, select **Quickdraw Community > Search for Contours**.
- 2 Use the map and search features to locate an area to download.  
The red dots represent Garmin Quickdraw Contours maps that have been shared for that area.
- 3 Select **Select Download Region**.
- 4 Drag the box to select the area to download.
- 5 Drag the corners to change the download area.
- 6 Select **Download Area**.

The next time you connect the ActiveCaptain app to the ECHOMAP UHD2 device, the downloaded contours are transferred to the device automatically.

### Sharing Your Garmin Quickdraw Contours Maps with the Garmin Quickdraw Community Using ActiveCaptain

You can share Garmin Quickdraw Contours maps that you have created with others in the Garmin Quickdraw Community.

When you share a contour map, only the contour map is shared. Your waypoints are not shared.

When you set up your ActiveCaptain app, you may have selected to share your contours with the community automatically. If not, follow these steps to enable sharing.

From the ActiveCaptain app on your mobile device, select **Sync with Plotter > Contribute to Community**.

The next time you connect the ActiveCaptain app to the ECHOMAP UHD2 device, your contour maps are transferred to the community automatically.

### Connecting to the Garmin Quickdraw Community with Garmin Connect

- 1 Go to [connect.garmin.com](https://connect.garmin.com).
- 2 Select **Getting Started > Quickdraw Community > Getting Started**.
- 3 If you do not have a Garmin Connect account, create one.
- 4 Sign in to your Garmin Connect account.
- 5 Select **Dashboards > Marine** to open the Garmin Quickdraw widget.

**TIP:** Make sure you have a memory card in your computer to share Garmin Quickdraw Contours maps.



## Sharing Your Garmin Quickdraw Contours Maps with the Garmin Quickdraw Community Using Garmin Connect

You can share Garmin Quickdraw Contours maps that you have created with others in the Garmin Quickdraw Community.

When you share a contour map, only the contour map is shared. Your waypoints are not shared.

- 1 Insert a memory card into the card slot (*Inserting Memory Cards, page 4*).
- 2 Insert the memory card into your computer.
- 3 Access the Garmin Quickdraw Community (*Connecting to the Garmin Quickdraw Community with Garmin Connect, page 24*).
- 4 Select **Share Your Contours**.
- 5 Browse to your memory card, and select the /Garmin folder.
- 6 Open the Quickdraw folder, and select the file named ContoursLog.svy.

After the file is uploaded, delete the ContoursLog.svy file from your memory card to avoid issues with future uploads. Your data will not be lost.

## Downloading Garmin Quickdraw Community Maps Using Garmin Connect

You can download Garmin Quickdraw Contours maps that other users have created and shared with the Garmin Quickdraw Community.

If your device does not have Wi-Fi technology, you can access the Garmin Quickdraw Community using the Garmin Connect website.

If your device has Wi-Fi technology, you should access the Garmin Quickdraw Community using the ActiveCaptain app (*Connecting to the Garmin Quickdraw Community with ActiveCaptain, page 24*).

- 1 Insert the memory card into your computer.
- 2 Access the Garmin Quickdraw Community (*Connecting to the Garmin Quickdraw Community with Garmin Connect, page 24*).
- 3 Select **Search for Contours**.
- 4 Use the map and search features to locate an area to download.  
The red dots represent Garmin Quickdraw Contours maps that have been shared for that region.
- 5 Select **Select an Area to Download**.
- 6 Drag the edges of the box to select the area to download.
- 7 Select **Start Download**.
- 8 Save the file to your memory card.  
**TIP:** If you cannot find the file, look in the "Downloads" folder. The browser may have saved the file there.
- 9 Remove the memory card from your computer.
- 10 Insert the memory card into the card slot (*Inserting Memory Cards, page 4*).

The chartplotter automatically recognizes the contours maps. The chartplotter may take a few minutes to load the maps.

## Garmin Quickdraw Contours Settings

From a chart, select **MENU > Quickdraw Contours > Settings**.

**Recording Offset:** Sets the distance between the sonar depth and the contour recording depth. If the water level has changed since your last recording, adjust this setting so the recording depth is the same for both recordings.

For example, if the last time you recorded had a sonar depth of 3.1 m (10.5 ft.), and today's sonar depth is 3.6 m (12 ft.), enter -0.5 m (-1.5 ft.) for the a Recording Offset value.

**User Display Offset:** Sets differences in contour depths and depth labels on your own contours maps to compensate for changes in the water level of a body of water, or for depth errors in recorded maps.

**Comm. Display Offset:** Sets differences in contour depths and depth labels on the community contours maps to compensate for changes in the water level of a body of water, or for depth errors in recorded maps.

**Survey Coloring:** Sets the color of the Garmin Quickdraw Contours display. When this setting is turned on, the colors indicate the quality of the recording. When this setting is turned off, the contour areas use standard map colors.

Green indicates good depth and GPS position, and a speed under 16 km/h (10 mph). Yellow indicates good depth and GPS position, and a speed between 16 and 32 km/h (10 and 20 mph). Red indicates poor depth or GPS position, and a speed above 32 km/h (20 mph).

**Depth Shading:** Specifies the minimum and maximum depths of a depth range and a color for that depth range.

## Navigation with a Chartplotter

### WARNING

All route and navigation lines displayed on the chartplotter are only intended to provide general route guidance or to identify proper channels, and are not intended to be precisely followed. Always defer to the nav aids and conditions on the water when navigating to avoid groundings or hazards that could result in vessel damage, personal injury, or death.

The Auto Guidance feature is based on electronic chart information. That data does not ensure obstacle and bottom clearance. Carefully compare the course to all visual sightings, and avoid any land, shallow water, or other obstacles that may be in your path.

When using Go To, a direct course and a corrected course may pass over land or shallow water. Use visual sightings, and steer to avoid land, shallow water, and other dangerous objects.

**NOTE:** Some chart views are available with premium charts, in some areas.

To navigate, you must choose a destination, set a course or create a route, and follow the course or route. You can follow the course or the route on the Navigation chart, Fishing chart, Perspective 3D chart view, or Mariner's Eye 3D chart view.

You can set and follow a course to a destination using one of three methods: Go To, Route To, or Auto Guidance.

**Go To:** Takes you directly to the destination. This is the standard option for navigating to a destination. The chartplotter creates a straight-line course or navigation line to the destination. The path may run over land and other obstacles.

**Route To:** Creates a route from your location to a destination, allowing you to add turns along the way. This option provides a straight-line course to the destination, but allows you to add turns into the route to avoid land and other obstacles.

**Auto Guidance:** Uses the specified information about your vessel and chart data to determine the best path to your destination. This option is available only when using a compatible premium chart in a compatible chartplotter. It provides a turn-by-turn navigation path to the destination, avoiding land and other obstacles ([Auto Guidance, page 33](#)).

**NOTE:** Auto Guidance is available with premium charts, in some areas.

The color of the route line changes depending upon several factors ([Route Color Coding, page 27](#)).



## Basic Navigation Questions

Question	Answer
How do I make the chartplotter point me in the direction in which I want to go (bearing)?	Navigate using Go To ( <a href="#">Setting and Following a Direct Course Using Go To</a> , page 28).
How do I make the device guide me along a straight line (minimizing cross track) to a location using the shortest distance from the present location?	Build a single-leg route and navigate it using Route To ( <a href="#">Creating and Navigating a Route From Your Present Location</a> , page 31).
How do I make the device guide me to a location while avoiding charted obstacles?	Build a multi-leg route and navigate it using Route To ( <a href="#">Creating and Navigating a Route From Your Present Location</a> , page 31).
Can the device create a path for me?	If you have premium maps that support Auto Guidance and are in an area covered by Auto Guidance, navigate using Auto Guidance ( <a href="#">Setting and Following an Auto Guidance Path</a> , page 33).
How do I change the Auto Guidance settings for my boat?	See <a href="#">Auto Guidance Path Configurations</a> , page 35.

## Route Color Coding

### WARNING

All route and navigation lines displayed on the chartplotter are only intended to provide general route guidance or to identify proper channels, and are not intended to be precisely followed. Always defer to the nav aids and conditions on the water when navigating to avoid groundings or hazards that could result in vessel damage, personal injury, or death.

The Auto Guidance feature is based on electronic chart information. That data does not ensure obstacle and bottom clearance. Carefully compare the course to all visual sightings, and avoid any land, shallow water, or other obstacles that may be in your path.

When using Go To, a direct course and a corrected course may pass over land or shallow water. Use visual sightings, and steer to avoid land, shallow water, and other dangerous objects.

As you navigate, the color of the route might change to indicate when you should take caution.

**Magenta:** Default route/course line.

**Thin purple:** Dynamically corrected course, indicating you are off course.

**Orange:** Caution! This segment of the route may be near the thresholds of the Auto Guidance depth and height settings. For example, the route segment is orange when the route crosses under a bridge or is in potentially shallow waters. Garmin Navionics+ and Garmin Navionics Vision+ charts only.

**Red striped:** Warning! This segment of the route might be unsafe, based on the Auto Guidance depth and height settings. For example, the route segment is red striped when the route crosses under a very low bridge or is in shallow waters. This line is red striped in Garmin Navionics+ and Garmin Navionics Vision+ charts only; it is magenta and gray striped in previous versions of the charts.

**Gray:** Cannot calculate this segment of the route due to land or other obstacles, or there is no chart coverage area in that location.

## Destinations

You can select destinations using various charts and 3D chart views or using the lists.

## Searching for a Destination by Name

You can search for saved waypoints, saved routes, saved tracks, and marine services destinations by name.

- 1 Select  > **Services** > **Search by Name**.
- 2 Enter at least a portion of the name of your destination.
- 3 If necessary, select **Done**.  
The 50 nearest destinations that contain your search criteria appear.
- 4 Select the destination.

## Selecting a Destination Using the Navigation Chart

From the Navigation chart, select a destination.

## Searching for a Marine Services Destination

**NOTE:** This feature is available with premium charts, in some areas.

The chartplotter contains information for thousands of destinations offering marine services.

- 1 Select  > **Services**.
- 2 Select **Offshore Services** or **Inland Services**.
- 3 If necessary, select the marine service category.  
The chartplotter shows a list of the nearest locations and the distance and bearing to each.
- 4 Select a destination to view more information about the destination, if available.  
You can use the arrow keys to scroll through the list of nearest destinations.

## Setting and Following a Direct Course Using Go To

### **WARNING**

When using Go To, a direct course and a corrected course may pass over land or shallow water. Use visual sightings, and steer to avoid land, shallow water, and other dangerous objects.

You can set and follow a direct course from your current location to a selected destination.

- 1 Select a destination (*Destinations, page 27*).
- 2 Select **Navigate To** > **Go To**.  
A magenta line appears. In the center of the magenta line is a thinner purple line that represents the corrected course from your current location to the destination. The corrected course is dynamic, and it moves with your boat when you are off course.
- 3 Follow the magenta line, steering to avoid land, shallow water, and other obstacles.
- 4 If you are off course, follow the purple line (corrected course) to go to your destination, or steer back to the magenta line (direct course).  
You can also use the orange course-to-steer arrow, which shows a proposed turning radius to return your boat to the course.

### **WARNING**

Review the path for obstacles before negotiating the turn. If the path is unsafe, reduce your boat speed and determine a safe path back to the course.

## Stopping Navigation

While navigating, from an applicable chart, select an option:

- Select **MENU** > **Stop Navigation**.
- When navigating with Auto Guidance, select **MENU** > **Navigation Options** > **Stop Navigation**.

## Waypoints

Waypoints are locations you record and store in the device. Waypoints can mark where you are, where you are going, or where you have been. You can add details about the location, such as name, elevation, and depth.

### Marking Your Present Location as a Waypoint

From any screen, select **MARK**.

### Creating a Waypoint at a Different Location

- 1 From a chart, select  > **Waypoints** > **New Waypoint**.
- 2 Select an option:
  - To create the waypoint by entering position coordinates, select **Enter Coordinates**, and enter the coordinates.
  - To create the waypoint using a chart, select **Use Chart**, select the location, and select **Create Waypoint**.
  - To create the waypoint using a range (distance) and bearing, select **Enter Range/Bearing**, and enter the information.

### Marking an MOB Location

Select **MARK** > **Man Overboard**.

An international man overboard (MOB) symbol marks the active MOB point and the chartplotter sets a direct course back to the marked location.

### Projecting a Waypoint

You can create a new waypoint by projecting the distance and bearing from a different location. This can be helpful when creating sail racing start and finish lines.

- 1 Select  > **Waypoints** > **New Waypoint** > **Enter Range/Bearing**.
- 2 If necessary, select a reference point on the chart.
- 3 Select **Enter Range/Bearing**.
- 4 Enter the distance, and select **Done**.
- 5 Enter the bearing, and select **Done**.
- 6 Select **Create Waypoint**.

### Viewing a List of all Waypoints

Select an option:

- Select  > **Waypoints**.
- From a chart or 3D chart view, select **MENU** > **Waypoints**.

### Editing a Saved Waypoint

- 1 Select  > **Waypoints**.
- 2 Select a waypoint.
- 3 Select **Review** > **Edit**.
- 4 Select an option:
  - To add a name, select **Name**, and enter a name.
  - To change the symbol, select **Symbol**.
  - To move the position of the waypoint, select **Position**.
  - To change the depth, select **Depth**.
  - To change the water temperature, select **Water Temp..**
  - To change the comment, select **Comment**.

## Moving a Saved Waypoint

- 1 Select  > **Waypoints**.
- 2 Select a waypoint.
- 3 Select **Review > Edit > Position**.
- 4 Indicate a new location for the waypoint:
  - To move the waypoint using coordinates, select **Enter Coordinates**, enter the new coordinates, and select **Done** or **Cancel**.
  - To move the waypoint while using the chart, select **Use Chart**, select a new location on the chart, and select **Move Waypoint**.
  - To move the waypoint using the vessel's current position, select **Use Current Position**.
  - To move the waypoint using a range (distance) and bearing, select **Enter Range/Bearing**, enter the information, and select **Done**.

## Browsing for and Navigating to a Saved Waypoint

### **WARNING**

All route and navigation lines displayed on the chartplotter are only intended to provide general route guidance or to identify proper channels, and are not intended to be precisely followed. Always defer to the nav aids and conditions on the water when navigating to avoid groundings or hazards that could result in vessel damage, personal injury, or death.

The Auto Guidance feature is based on electronic chart information. That data does not ensure obstacle and bottom clearance. Carefully compare the course to all visual sightings, and avoid any land, shallow water, or other obstacles that may be in your path.

When using Go To, a direct course and a corrected course may pass over land or shallow water. Use visual sightings, and steer to avoid land, shallow water, and other dangerous objects.

**NOTE:** Auto Guidance is available with premium charts, in some areas.

Before you can navigate to a waypoint, you must create a waypoint.

- 1 Select  > **Waypoints**.
- 2 Select a waypoint.
- 3 Select **Navigate To**.
- 4 Select an option:
  - To navigate directly to the location, select **Go To**.
  - To create a route to the location, including turns, select **Route To**.
  - To use Auto Guidance, select **Auto Guidance**.
- 5 Review the course indicated by the magenta line.

**NOTE:** When using Auto Guidance, a gray segment within any part of the magenta line indicates that Auto Guidance cannot calculate part of the Auto Guidance line. This is due to the settings for minimum safe water depth and minimum safe obstacle height.
- 6 Follow the magenta line, steering to avoid land, shallow water, and other obstacles.

## Deleting a Waypoint or an MOB

- 1 Select  > **Waypoints**.
- 2 Select a waypoint or an MOB.
- 3 Select **Review > Delete**.

## Deleting All Waypoints

Select  > **Manage User Data > Delete User Data > Waypoints > All**.

## Routes

A route is a path from one location to one or more destinations.

### Creating and Navigating a Route From Your Present Location

You can create and immediately navigate a route on the Navigation chart or the Fishing chart. This method does not save the route.

- 1 From the Navigation chart or Fishing chart, select a destination.
- 2 Select **SELECT > Route To**.
- 3 Select the location of the last turn before the destination.
- 4 Select **SELECT > Add Turn**.
- 5 If necessary, repeat to add turns, working backward from the destination to the present location of your vessel.  
The last turn you add should be the first turn you make, starting from your present location. It should be the turn closest to your vessel.
- 6 Select **SELECT > Done**.
- 7 Review the course indicated by the magenta line.
- 8 Follow the magenta line, steering to avoid land, shallow water, and other obstacles.

### Creating and Saving a Route

You can add up to 250 turns to one route.

- 1 Select **🏠 > Routes > New > Route Using Chart**.
- 2 Select the starting location of the route.  
The starting point can be your present location or another location.
- 3 Select **Add Turn**.
- 4 Select the location of the next turn on the chart.
- 5 Select **Add Turn**.
- 6 If necessary, repeat steps 4 and 5 to add more turns.
- 7 Select **Done**.

### Viewing a List of Routes and Auto Guidance Paths

- 1 Select **🏠 > Routes**.
- 2 If necessary, select **Filter** to see routes only or Auto Guidance paths only.
- 3 Select **Sort** to sort the list of available routes by range, length, or name.

### Editing a Saved Route

You can change the name of a route or change the turns the route contains.

- 1 Select **🏠 > Routes**.
- 2 Select a route.
- 3 Select **Review > Edit Route**.
- 4 Select an option:
  - To change the name, select **Name**, and enter the name.
  - To edit a turn from a list, select **Edit Turns > Use Turn List**, and select a turn from the list.
  - To select a turn using the chart, select **Edit Turns > Use Chart**, and select a location on the chart.

Modifying a turn that uses a saved waypoint does not move that waypoint, it relocates the turn in the route. Moving the location of a waypoint used in a route does not move the turn in the route.

## Finding and Navigating a Saved Route

Before you can browse a list of routes and navigate to one of them, you must create and save at least one route ([Creating and Saving a Route, page 31](#)).

- 1 Select  > **Routes**.
- 2 Select a route.
- 3 Select **Navigate To**.
- 4 Select an option:
  - To navigate the route from the starting point used when the route was created, select **Forward**.
  - To navigate the route from the destination point used when the route was created, select **Backward**.
  - To navigate parallel to the route, select **Offset** ([Browsing for and Navigating Parallel to a Saved Route, page 32](#)).
  - To navigate a route from the route's first waypoint, select **From Start**.

A magenta line appears. In the center of the magenta line is a thinner purple line that represents the corrected course from your present location to the destination. The corrected course is dynamic, and it moves with your boat when you are off course.

- 5 Review the course indicated by the magenta line.
- 6 Follow the magenta line along each leg in the route, steering to avoid land, shallow water, and other obstacles.
- 7 If you are off course, follow the purple line (corrected course) to go to your destination, or steer back to the magenta line (direct course).

## Browsing for and Navigating Parallel to a Saved Route

Before you can browse a list of routes and navigate to one of them, you must create and save at least one route ([Creating and Saving a Route, page 31](#)).

- 1 Select  > **Routes**.  
**NOTE:** Auto Guidance is available with premium charts, in some areas.
- 2 Select a route.
- 3 Select **Navigate To**.
- 4 Select **Offset** to navigate parallel to the route.
- 5 Select **Offset** to enter the distance to offset from the route.
- 6 Indicate how to navigate the route:
  - To navigate the route from the starting point used when the route was created, to the left of the original route, select **Forward - Port**.
  - To navigate the route from the starting point used when the route was created, to the right of the original route, select **Forward - Starboard**.
  - To navigate the route from the destination point used when the route was created, to the left of the original route, select **Backward - Port**.
  - To navigate the route from the destination point used when the route was created, to the right of the original route, select **Backward - Starboard**.

- 7 If necessary, select **Done**.

A magenta line appears. In the center of the magenta line is a thinner purple line that represents the corrected course from your present location to the destination. The corrected course is dynamic, and it moves with your boat when you are off course.

- 8 Review the course indicated by the magenta line.
- 9 Follow the magenta line along each leg in the route, steering to avoid land, shallow water, and other obstacles.
- 10 If you are off course, follow the purple line (corrected course) to go to your destination, or steer back to the magenta line (direct course).

## Initiating a Search Pattern

You can initiate a search pattern to search an area. Different patterns are better suited for different search situations.

- 1 Select  > **Routes** > **New** > **Route Using SAR Pattern**.
- 2 Select a pattern:
  - Select **Sector Search** when the location of the object is fairly known, the search area is small, and an intensive search is needed.
  - Select **Expanding Square** when the location of the object is somewhat doubtful, the search area is small, and an intensive search is needed.
  - Select **Creeping/Parallel Line** when the location of the object is approximate, the search area is small, and a consistent search is needed.
- 3 Enter the search parameters.
- 4 Select **Done**.

## Deleting a Saved Route

- 1 Select  > **Routes**.
- 2 Select a route.
- 3 Select **Review** > **Delete**.

## Deleting All Saved Routes

Select  > **Manage User Data** > **Delete User Data** > **Routes**.

## Auto Guidance

### **WARNING**

The Auto Guidance feature is based on electronic chart information. That data does not ensure obstacle and bottom clearance. Carefully compare the course to all visual sightings, and avoid any land, shallow water, or other obstacles that may be in your path.

All route and navigation lines displayed on the chartplotter are only intended to provide general route guidance or to identify proper channels, and are not intended to be precisely followed. Always defer to the navaids and conditions on the water when navigating to avoid groundings or hazards that could result in vessel damage, personal injury, or death.

**NOTE:** Auto Guidance is available with premium charts, in some areas.

You can use Auto Guidance to plot the best path to your destination. Auto Guidance uses your chartplotter to scan chart data, such as water depth and known obstacles, to calculate a suggested path. You can adjust the path during navigation.

## Setting and Following an Auto Guidance Path

- 1 Select a destination (*Destinations, page 27*).
- 2 Select **Navigate To** > **Auto Guidance**.
- 3 Review the path, indicated by the magenta line.
- 4 Select **Start Navigation**.
- 5 Follow the magenta line, steering to avoid land, shallow water, and other obstacles (*Route Color Coding, page 27*).

**NOTE:** When using Auto Guidance, a gray segment within any part of the magenta line indicates that Auto Guidance cannot calculate part of the Auto Guidance line. This is due to the settings for minimum safe water depth and minimum safe obstacle height.

## Creating and Saving an Auto Guidance Path

- 1 Select **← > Routes > New > Auto Guidance**.
- 2 Select a starting point, and select **Next**.
- 3 Select a destination, and select **Next**.
- 4 Select an option:
  - To view a hazard and adjust the path near a hazard, select **Hazard Review**.
  - To adjust the path, select **Adjust Path**, and follow the on-screen instructions.
  - To delete the path, select **Cancel Auto Guidance**.
  - To save the path, select **Done**.

## Adjusting a Saved Auto Guidance Path

- 1 Select **← > Routes**.
- 2 Select a path, and select **Review > Edit > Adjust Path**.  
**TIP:** When navigating an Auto Guidance path, select the path on the navigation chart, and select Adjust Path.
- 3 Select a location on the path.
- 4 Use the arrow keys to move the point to a new location.
- 5 If necessary, select a point, and select **Remove**.
- 6 Select **Done**.

## Canceling an Auto Guidance Calculation in Progress

From the Navigation chart, select **MENU > Cancel**.

**TIP:** You can select BACK to quickly cancel the calculation.

## Setting a Timed Arrival

You can use this feature on a route or an Auto Guidance path to get feedback about when you should arrive at a selected point. This allows you to time your arrival at a location, such as a bridge opening or a race starting line.

- 1 From the Navigation chart, select **MENU**.
- 2 Select **Timed Arrival**.

**TIP:** You can quickly open the Timed Arrival menu by selecting a point on the path or route.



## Auto Guidance Path Configurations

### CAUTION

The Preferred Depth and Vertical Clearance settings influence how the chartplotter calculates an Auto Guidance path. If a section of an Auto Guidance path is shallower than the Preferred Depth or lower than the Vertical Clearance settings, the section of the Auto Guidance path appears as a solid orange line or a red striped line in Garmin Navionics+ and Garmin Navionics Vision+ charts and appears as a magenta and gray striped line in previous versions. When your boat enters one of those areas, a warning message appears ([Route Color Coding, page 27](#)).

---

**NOTE:** Auto Guidance is available with premium charts, in some areas.

**NOTE:** Not all settings apply to all maps.

You can set the parameters the chartplotter uses when calculating an Auto Guidance path.

Select  > **Preferences** > **Navigation** > **Auto Guidance**.

**Preferred Depth:** Sets the minimum water depth, based on chart depth data, that your boat can safely travel over.



**NOTE:** The minimum water depth for the premium charts (made before 2016) is 3 feet. If you enter a value of less than 3 feet, the charts only use depths of 3 feet for Auto Guidance path calculations.



**Vertical Clearance:** Sets the minimum height of a bridge or obstacle, based on chart data, that your boat can safely travel under.

**Shoreline Distance:** Sets how close to the shore you want the Auto Guidance path to be placed. The path may move if you change this setting while navigating. The available values for this setting are relative, not absolute. To ensure that path is placed the appropriate distance from shore, you can assess the placement of the path using one or more familiar destinations that require navigation through a narrow waterway ([Adjusting the Distance from Shore, page 36](#)).

## Adjusting the Distance from Shore

The Shoreline Distance setting indicates how close to the shore you want the Auto Guidance line to be placed. The Auto Guidance line may move if you change this setting while navigating. The available values for the Shoreline Distance setting are relative, not absolute. To ensure the Auto Guidance line is placed the appropriate distance from shore, you can assess the placement of the Auto Guidance line using one or more familiar destinations that require navigation through a narrow waterway.

- 1 Dock your vessel or drop the anchor.
- 2 Select  > **Preferences > Navigation > Auto Guidance > Shoreline Distance > Normal**.
- 3 Select a destination that you have navigated to previously.
- 4 Select **Navigate To > Auto Guidance**.
- 5 Review the placement of the **Auto Guidance** line, and determine whether the line safely avoids known obstacles and the turns enable efficient travel.
- 6 Select an option:
  - If the placement of the line is satisfactory, select **MENU > Navigation Options > Stop Navigation**, and proceed to step 10.
  - If the line is too close to known obstacles, select  > **Preferences > Navigation > Auto Guidance > Shoreline Distance > Far**.
  - If the turns in the line are too wide, select  > **Preferences > Navigation > Auto Guidance > Shoreline Distance > Near**.
- 7 If you selected **Near** or **Far** in step 6, review the placement of the **Auto Guidance** line, and determine whether the line safely avoids known obstacles and the turns enable efficient travel.

Auto Guidance maintains a wide clearance from obstacles in open water, even if you set the Shoreline Distance setting to Near or Nearest. As a result, the chartplotter may not reposition the Auto Guidance line, unless the destination selected requires navigation through a narrow waterway.
- 8 Select an option:
  - If the placement of the line is satisfactory, select **MENU > Navigation Options > Stop Navigation**, and proceed to step 10.
  - If the line is too close to known obstacles, select  > **Preferences > Navigation > Auto Guidance > Shoreline Distance > Farthest**.
  - If the turns in the line are too wide, select  > **Preferences > Navigation > Auto Guidance > Shoreline Distance > Nearest**.
- 9 If you selected **Nearest** or **Farthest** in step 8, review the placement of the **Auto Guidance** line, and determine whether the line safely avoids known obstacles and the turns enable efficient travel.

The Auto Guidance path maintains a wide clearance from obstacles in open water, even if you set the Shoreline Distance setting to Near or Nearest. As a result, the chartplotter may not reposition the Auto Guidance line, unless the destination selected requires navigation through a narrow waterway.
- 10 Repeat steps 3 through 9 at least once more, using a different destination each time, until you are familiar with the functionality of the **Shoreline Distance** setting.

## Tracks

A track is a recording of the path of your boat. The track currently being recorded is called the active track, and it can be saved. You can show tracks in each chart or 3D chart view.

### Showing Tracks

- 1 From a chart, select **MENU > Layers > Manage User Data > Tracks**.
- 2 Select the tracks to display.

A trailing line on the chart indicates your track.

## Setting the Color of the Active Track

- 1 Select  > **Tracks** > **Active Track Options** > **Track Color**.
- 2 Select a track color.

## Saving the Active Track

The track currently being recorded is called the active track.

- 1 Select  > **Tracks** > **Save Active Track**.
- 2 Select an option:
  - Select the time the active track began.
  - Select **Entire Log**.
- 3 Select **Save**.

## Viewing a List of Saved Tracks

Select  > **Tracks** > **Saved Tracks**.

## Editing a Saved Track

- 1 Select  > **Tracks** > **Saved Tracks**.
- 2 Select a track.
- 3 Select **Review** > **Edit Track**.
- 4 Select an option:
  - Select **Name**, and enter the new name.
  - Select **Track Color**, and select a color.
  - Select **Save as Route** to save the track as a route.
  - Select **Save as Boundary** to save the track as a boundary.

## Saving a Track as a Route

- 1 Select  > **Tracks** > **Saved Tracks**.
- 2 Select a track.
- 3 Select **Review** > **Edit Track** > **Save as Route**.

## Browsing for and Navigating a Recorded Track

Before you can browse a list of tracks and navigate to them, you must record and save at least one track.

- 1 Select  > **Tracks** > **Saved Tracks**.
- 2 Select a track.
- 3 Select **Follow Track**.
- 4 Select an option:
  - To navigate the track from the starting point used when the track was created, select **Forward**.
  - To navigate the track from the destination point used when the track was created, select **Backward**.
- 5 Review the course indicated by the colored line.
- 6 Follow the line along each leg in the route, steering to avoid land, shallow water, and other obstacles.

## Deleting a Saved Track

- 1 Select  > **Tracks** > **Saved Tracks**.
- 2 Select a track.
- 3 Select **Review** > **Delete**.

## Deleting All Saved Tracks

Select  > **Manage User Data** > **Delete User Data** > **Saved Tracks**.

## Retracing the Active Track

The track currently being recorded is called the active track.

- 1 Select  > **Tracks** > **Follow Active Track**.
- 2 Select an option:
  - Select the time the active track began.
  - Select **Entire Log**.
- 3 Review the course indicated by the colored line.
- 4 Follow the colored line, steering to avoid land, shallow water, and other obstacles.

## Clearing the Active Track

Select  > **Tracks** > **Clear Active Track**.

The track memory is cleared, and the active track continues to be recorded.

## Managing the Track Log Memory During Recording

- 1 Select  > **Tracks** > **Active Track Options**.
- 2 Select **Record Mode**.
- 3 Select an option:
  - To record a track log until the track memory is full, select **Fill**.
  - To continuously record a track log, replacing the oldest track data with new data, select **Wrap**.

## Configuring the Recording Interval of the Track Log

You can indicate the frequency at which the track plot is recorded. Recording more frequent plots is more accurate but fills the track log faster. The resolution interval is recommended for the most efficient use of memory.

- 1 Select  > **Tracks** > **Active Track Options** > **Interval** > **Interval**.
- 2 Select an option:
  - To record the track based on a distance between points, select **Distance** > **Change**, and enter the distance.
  - To record the track based on a time interval, select **Time** > **Change**, and enter the time interval.
  - To record the track plot based on a variance from your course, select **Resolution** > **Change**, and enter the maximum error allowed from the true course before recording a track point. This is the recommended recording option.

## Boundaries

### CAUTION

The Beeper setting must be turned on to make alarms audible ([Sounds and Display Settings, page 58](#)). Failure to set audible alarms could lead to injury or property damage.

Boundaries allow you to avoid or remain in designated areas in a body of water. You can set an alarm to alert you when you enter or exit a boundary.

You can create boundary areas, lines, and circles using the map. You can also convert saved tracks and routes into boundary lines. You can create a boundary area using waypoints by creating a route from the waypoints, and converting the route into a boundary line.

You can select a boundary to act as the active boundary. You can add the active boundary data to the data fields on the chart.

## Creating a Boundary

- 1 Select  > **Boundaries** > **New**.
- 2 Select a boundary shape.
- 3 Follow the on-screen instructions.

## Converting a Route to a Boundary

- 1 Select **←** > **Routes**.
- 2 Select a route.
- 3 Select **Review** > **Edit Route** > **Save as Boundary**.

## Converting a Track to a Boundary

- 1 Select **←** > **Tracks** > **Saved Tracks**.
- 2 Select a track.
- 3 Select **Review** > **Edit Track** > **Save as Boundary**.

## Editing a Boundary

- 1 Select **←** > **Boundaries**.
- 2 Select a boundary.
- 3 Select **Review**.
- 4 Select an option:
  - To edit the appearance of the boundary on the chart, select **Display Options**.
  - To change the boundary lines or name, select **Edit Boundary**.
  - To edit the boundary alarm, select **Alarm**.

## Setting a Boundary Alarm

Boundary alarms alert you when you are within a specified distance of a set boundary. This can be helpful when attempting to avoid certain areas or when you should be very alert in certain areas, such as shipping lanes.

- 1 Select **←** > **Boundaries**.
- 2 Select a boundary.
- 3 Select **Review** > **Alarm**.
- 4 Select an option:
  - To set an alarm for when your boat is a specified distance from the boundary, select **Warning Dist.**, enter a distance, and select **Done**.
  - To set an alarm for when you enter or exit an area boundary or a circle boundary, select **Area** to show **Entering** or **Exiting**.

## Disabling all Boundary Alarms

Select **←** > **Manage User Data** > **Boundaries** > **Alarms**.

## Deleting a Boundary

- 1 Select **←** > **Boundaries**.
- 2 Select a boundary.
- 3 Select **Review** > **Edit Boundary** > **Delete**.

## Deleting All Saved Waypoints, Tracks, Routes, and Boundaries

Select **←** > **Manage User Data** > **Delete User Data** > **Delete All User Data** > **OK**.

# Sonar Fishfinder

When properly connected to a compatible transducer, your chartplotter can be used as a fishfinder.

For more information about which transducer is best for your needs, go to [garmin.com/transducers](http://garmin.com/transducers).

Different sonar views can help you view the fish in the area. The sonar views available vary depending on the type of transducer and sounder module connected to the chartplotter. For example, you can view certain Panoptix™ sonar screens only if you have a compatible Panoptix transducer connected.

There are four basic styles of sonar views available: a full-screen view, a split-screen view that combines two or more views, a split-zoom view, and a split-frequency view that displays two different frequencies. You can customize the settings for each view in the screen. For example, if you are viewing the split-frequency view, you can separately adjust the gain for each frequency.

If you do not see an arrangement of sonar views to suit your needs, you can create a custom combination screen (*Customizing with Combination Pages, page 6*).

## Stopping the Transmission of Sonar Signals

- To disable the active sonar, from the sonar screen, select **MENU > Transmit**.
- To disable all sonar transmissions, press , and select **Disable All Sonar Trans..**

## Traditional Sonar View

There are several full-screen views available, depending on the transducer that is connected.

The full-screen Traditional sonar view shows a large image of the sonar readings from a transducer. The range scale along the right side of the screen shows the depth of detected objects as the screen scrolls from the right to the left.

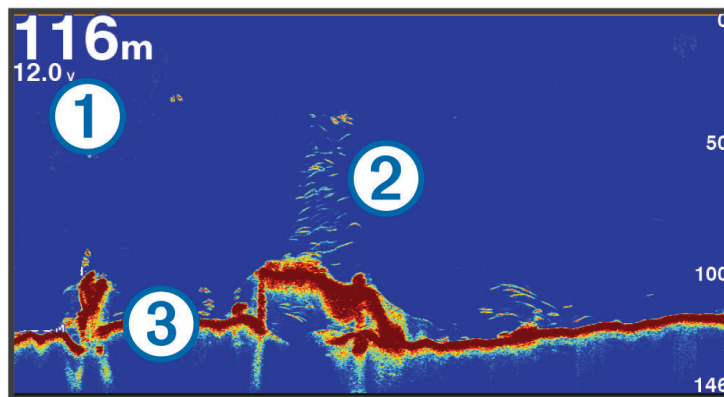

①	Depth information
②	Suspended targets or fish
③	Bottom of the body of water

## Split-Frequency Sonar View

In the split-frequency sonar view, the two sides of the screen show a full-view graph of sonar data of different frequencies.

**NOTE:** The split-frequency sonar view requires the use of a dual-frequency transducer.

## Split-Zoom Sonar View

The split-zoom sonar view shows a full-view graph of sonar readings, and a magnified portion of that graph, on the same screen.

## Garmin ClearVü Sonar View

**NOTE:** To receive Garmin ClearVü scanning sonar, you need a compatible transducer. For information about compatible transducers, go to [garmin.com/transducers](http://garmin.com/transducers).

Garmin ClearVü high-frequency sonar provides a detailed picture of the fishing environment around the boat in a detailed representation of structures the boat is passing over.

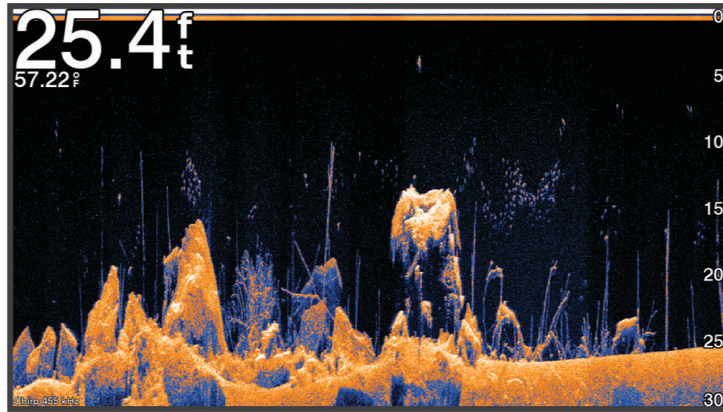

Traditional transducers emit a conical beam. The Garmin ClearVü scanning sonar technology emits a beam similar to the shape of the beam in a copy machine. This beam provides a clearer, picture-like image of what is beneath the boat.

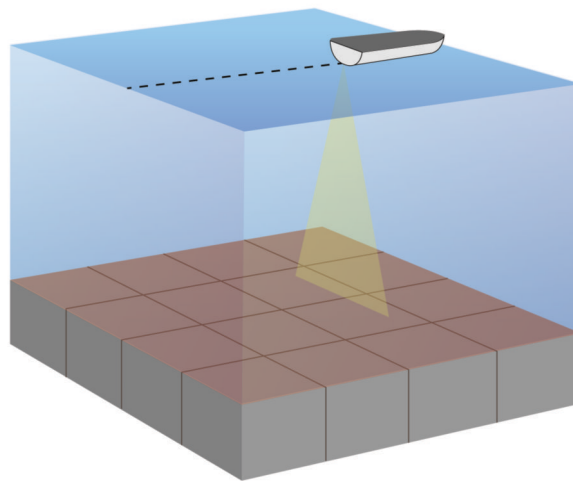

## Flasher View

The flasher shows sonar information on a circular depth scale, indicating what is beneath your boat. It is organized as a ring that starts at the top and progresses clockwise. Depth is indicated by the scale inside the ring. Sonar information flashes on the ring when it is received at the depth indicated.

The flasher colors indicate different strengths of the sonar return. The default color scheme follows a traditional sonar color palette, in which yellow indicates the strongest return, orange indicates a strong return, red indicates a weaker return, and blue indicates the weakest return.

Select **Sonar > Flasher**.

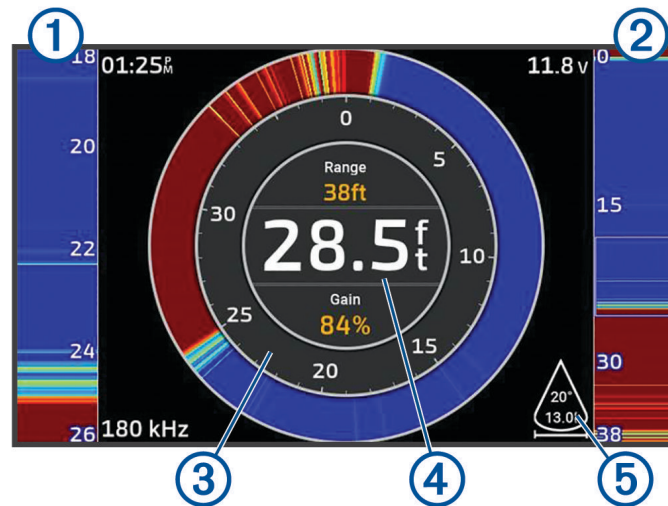

①	A-scope, zoomed-in view of the right side view
②	A-scope with zoom area outlined <sup>2</sup>
③	Depth scale
④	Depth at your present location
⑤	Angle and span of the transducer cone at the current frequency

<sup>2</sup> You can press ▲ and ▼ to move the zoom area up and down.



## Selecting the Transducer Type

This chartplotter is compatible with a range of accessory transducers, including the Garmin ClearVü™ transducers, which are available at [garmin.com/transducers](http://garmin.com/transducers).

If you are connecting a transducer that was not included with the chartplotter, you may need to set the transducer type to make the sonar function properly.

**NOTE:** Not all chartplotters and sonar modules support this feature.

1 Complete an action:

- From a sonar view, select **MENU > Sonar Setup > Installation > Transducers**.
- Select  > **My Vessel > Transducers**.

2 Select an option:

- To enable the chartplotter to detect the transducer automatically, select the transducer to change, and select **Auto Detect**.
- To select the transducer manually, learn the range for the installed transducer, select the transducer to change, select the option that matches the installed transducer, such as **Dual Beam (200/77 kHz)** or **Dual Freq (200/50 kHz)**, and select **Change Model**.

### NOTICE

Manually selecting a transducer could result in damage to the transducer or reduced transducer performance.

**NOTE:** If you select the transducer manually, disconnect that transducer, and then connect a different transducer, you should reset this option to **Auto Detect**.

## Selecting a Sonar Source

This feature may not be available with all models.

When you are using more than one sonar data source for a particular sonar view, you can select the source to use for that sonar view. For example, if you have two sources for Garmin ClearVü, you can select the source to use from the Garmin ClearVü sonar view.

- 1 Open the sonar view for which you will change the source.
- 2 Select **MENU > Sonar Setup > Source**.
- 3 Select the source for this sonar view.



## Renaming a Sonar Source

You can rename a sonar source to easily identify that source. For example, you use "Bow" as the name of the transducer on the bow of your boat.

To rename a source, you must be in the applicable sonar view for the source. For example, to rename the Garmin ClearVü sonar source, you must open the Garmin ClearVü sonar view.

- 1 From the sonar view, select **MENU > Sonar Setup > Source > Rename Sources**.
- 2 Enter the name.

## Creating a Waypoint on the Sonar Screen

- 1 From a sonar view, select  or .
- 2 Select a location.
- 3 Select .
- 4 If necessary, edit the waypoint information.

## Pausing the Sonar Display

From a sonar view, select  or .

To reactivate sonar after pausing, select BACK.

## Viewing Sonar History

You can scroll the sonar display to view historical sonar data.

**NOTE:** Not all transducers save historical sonar data.

- 1 From a sonar view, hold **◀** to scroll through the history.
- 2 Select **BACK** to exit history.

## Adjusting the Level of Detail

You can control the level of detail and noise shown on the sonar screen either by adjusting the gain for traditional transducers or by adjusting the brightness for Garmin ClearVü transducers.

If you want to see the highest intensity signal returns on the screen, you can lower the gain or brightness to remove lower intensity returns and noise. If you want to see all return information, you can increase the gain or brightness to see more information on the screen. This also increases noise, and can make it more difficult to recognize actual returns.

- 1 From a sonar view, select **MENU**.
- 2 Select **Gain** or **Brightness**.
- 3 Select an option:
  - To increase or decrease the gain or brightness manually, select **Up** or **Down**.
  - To allow the chartplotter to adjust the gain or brightness automatically, select an automatic option.

## Adjusting the Color Intensity

You can adjust the intensity of colors and highlight areas of interest on the sonar screen by adjusting the color gain for traditional transducers or the contrast for some transducers. This setting works best after you have adjusted the level of detail shown on the screen using the gain or brightness settings.

If you want to highlight smaller fish targets or create a higher intensity display of a target, you can increase the color gain or contrast setting. This causes a loss in the differentiation of the high intensity returns at the bottom. If you want to reduce the intensity of the return, you can reduce the color gain or contrast.

- 1 From a sonar view, select **MENU**.
- 2 Select an option based on sonar view:
  - Select **Contrast**.
  - Select **Sonar Setup > Appearance > Color Gain**.
- 3 Select an option:
  - To increase or decrease the color intensity manually, select **Up** or **Down**.
  - To use the default setting, select **Default**.

## Sonar Setup

**NOTE:** Not all options and settings apply to all models and transducers.

These settings apply to the following types of transducers.

- Traditional
- Garmin ClearVü

From a sonar view, select **MENU > Sonar Setup**.

**Scroll Speed:** Sets the rate at which the sonar scrolls from right to left ([Setting the Scroll Speed, page 46](#)).

In shallow water, you can select a slower scroll speed to extend the length of time the information is displayed on screen. In deeper water, you can select a faster scroll speed. Automatic scroll speed adjusts the scrolling speed to the speed the boat is traveling.

**Noise Reject:** Reduces the interference and the amount of clutter shown on the sonar screen ([Sonar Noise Rejection Settings, page 47](#)).

**Appearance:** Configures the appearance of the sonar screen ([Sonar Appearance Settings, page 47](#)).

**Alarms:** Sets sonar alarms ([Sonar Alarms, page 48](#)).

**Advanced:** Configures various sonar display and data source settings ([Advanced Sonar Settings, page 48](#)).

**Installation:** Configures the transducer ([Transducer Installation Settings, page 48](#)).

### Setting the Zoom Level on the Sonar Screen

1 From a sonar view, select **MENU > Zoom > ••• > Mode**.

2 Select an option:

- To set the depth and zoom automatically, select **Auto**.

If necessary, select **Set Zoom** to modify the zoom setting. Select **View Up** or **View Down** to set the depth range of the magnified area, and select **Zoom In** or **Zoom Out** to increase or decrease the magnification of the magnified area.

- To set the depth range of the magnified area manually, select **Manual**.

If necessary, select **Set Zoom** to modify the zoom setting. Select **View Up** or **View Down** to set the depth range of the magnified area, and select **Zoom In** or **Zoom Out** to increase or decrease the magnification of the magnified area.

- To magnify one particular area of the screen, select **Magnify**.

If necessary, select **Magnify** to increase or decrease the magnification level.

**TIP:** You can drag the magnification box to a new location on the screen.

- To zoom in on the sonar data from the bottom depth, select **Bottom Lock**.

If necessary, select **Span** to adjust the depth and placement of the bottom lock area.

To cancel the zoom, deselect the Zoom option.

## Setting the Scroll Speed

You can set the rate at which the sonar image moves across the screen. A higher scroll speed shows more detail until there is no additional detail to show, at which point it starts stretching out the existing detail. This can be useful while moving or trolling, or when you are in very deep water where the sonar is pinging very slowly. A lower scroll speed displays sonar information on the screen longer.

For most situations, the Default setting provides a good balance between a quickly scrolling image and less distorted targets.

1 From a sonar view, select **MENU > Sonar Setup > Scroll Speed**.

2 Select an option:

- To adjust the scroll speed automatically using speed-over-ground, select **Auto**.

The **Auto** setting selects a scroll rate to match the boat speed, so targets in the water are drawn with the correct aspect ratio and appear less distorted. When viewing Garmin ClearVü/SideVü sonar views or searching for structure, it is recommend to use the **Auto** setting.

- To scroll faster, select **Up**.
- To scroll more slowly, select **Down**.

## Adjusting the Range

You can adjust the range of the depth scale for traditional and Garmin ClearVü sonar views.

Allowing the device to adjust the range automatically keeps the bottom within the lower or outer third of the sonar screen, and can be useful for tracking a bottom that has minimal or moderate terrain changes.

Manually adjusting the range enables you to view a specified range, which can be useful for tracking a bottom that has large terrain changes, such as a drop-offs or cliffs. The bottom can appear on the screen as long as it appears within the range you have set.

1 From a sonar view, select **MENU > Range**.

2 Select an option:

- To allow the chartplotter to adjust the range automatically, select **Auto**.
- To increase or decrease the range manually, select **Up** or **Down**.

**TIP:** From the sonar screen, you can select **+** or **-** to manually adjust the range.

**TIP:** You can select **+** or **-** simultaneously to switch between the automatic and manual adjustment modes.

**TIP:** When viewing multiple sonar screens, you can select **SELECT** to choose the active screen.

**TIP:** When viewing a single sonar screen, you can select **SELECT** to change the shortcut for the **+** and **-** keys. Pressing **SELECT** repeatedly allows you to choose Range, Gain, or Magnify level.

## Sonar Noise Rejection Settings

From a sonar view, select **MENU > Sonar Setup > Noise Reject**.

**Interference:** Adjusts the sensitivity to reduce the effects of interference from nearby sources of noise.

The lowest interference setting that achieves the desired improvement should be used to remove interference from the screen. Correcting installation issues that cause noise is the best way to eliminate interference.

**Color Limit:** Hides part of the color palette to help eliminate fields of weak clutter.

By setting the color limit to the color of the undesired returns, you can eliminate the display of undesired returns on the screen.

**Smoothing:** Removes noise that is not part of a normal sonar return, and adjusts the appearance of returns, such as the bottom.

When smoothing is set to high, more of the low-level noise remains than when using the interference control, but the noise is more subdued because of averaging. Smoothing can remove speckle from the bottom.

Smoothing and interference work well together to eliminate low-level noise. You can adjust the interference and smoothing settings incrementally to remove undesirable noise from the display.

**Surface Noise:** Hides surface noise to help reduce clutter. Wider beam widths (lower frequencies) can show more targets, but can generate more surface noise.

**TVG:** Adjusts the time varying gain, which can reduce noise.

This control is best used for situations when you want to control and suppress clutter or noise near the water surface. It also allows for the display of targets near the surface that are otherwise hidden or masked by surface noise.

## Sonar Appearance Settings

From a sonar view, select **MENU > Sonar Setup > Appearance**.

**Color Scheme:** Sets the color scheme.





**Color Gain:** Adjusts the intensity of colors (*Adjusting the Color Intensity, page 44*).

**A-Scope:** Displays a vertical flasher along the right side of the screen that shows instantaneously the range to targets along a scale.

**Depth Line:** Shows a quick-reference depth line.

**Edge:** Highlights the strongest signal from the bottom to help define the hardness or softness of the signal.

**Fish Symbols:** Sets how the sonar interprets suspended targets.

	Shows suspended targets as symbols and background sonar information.
	Shows suspended targets as symbols with target depth information and background sonar information.
	Shows suspended targets as symbols.
	Shows suspended targets as symbols with target depth information.

**Pic. Advance:** Allows the sonar picture to advance faster by drawing more than one column of data on the screen for each column of sounder data received. This is especially helpful when you are using the sounder in deep water, because the sonar signal takes longer to travel to the water bottom and back to the transducer.

The 1/1 setting draws one column of information on the screen per sounder return. The 2/1 setting draws two columns of information on the screen per sounder return, and so on for the 4/1 and 8/1 settings.

**Overlay Data:** Sets the data shown on the sonar screen.

## Sonar Alarms

### WARNING

The sonar alarms feature is a tool for situational awareness only and may not prevent grounding in all circumstances. It is your obligation to ensure safe operation of the vessel.

### CAUTION

The Beeper setting must be turned on to make alarms audible (*Sounds and Display Settings, page 58*). Failure to set audible alarms could lead to injury or property damage.

**NOTE:** Not all options are available on all transducers.

From an applicable sonar view, select **MENU > Sonar Setup > Alarms**.

You can also open the sonar alarms by selecting  > **Alarms > Sonar**.



**Shallow Water:** Sets an alarm to sound when the depth is less than the specified value.

**Deep Water:** Sets an alarm to sound when the depth is greater than the specified value.

**Water Temp.:** Sets an alarm to sound when the transducer reports a temperature that is 2°F (1.1°C) above or below the specified temperature.

**Contour:** Sets an alarm to sound when the transducer detects a suspended target within the specified depth from the surface of the water and from the bottom.

**Fish:** Sets an alarm to sound when the device detects a suspended target.

-  sets the alarm to sound when fish of all sizes are detected.
-  sets the alarm to sound only when medium or large fish are detected.
-  sets the alarm to sound only when large fish are detected.

## Advanced Sonar Settings

From a Traditional sonar view, select **MENU > Sonar Setup > Advanced**.

**Btm. Srch. Limit:** Limits the search for the bottom to the depth selected when the Range setting is set to Auto. To minimize the length of time it takes to find the bottom, you can select a depth to limit the search for the bottom. The device will not search for the bottom deeper than the selected depth.

## Transducer Installation Settings

These settings apply to the following types of sonar.

- Traditional
- Garmin ClearVü

From an applicable sonar view, select an option.

- From a Traditional sonar view, select **MENU > Sonar Setup > Installation**.
- From a Garmin ClearVü sonar view, select **MENU > ClearVü Setup > Installation**.

**Restore Sonar Defaults:** Restores the sonar settings to the factory default values.

**Transducers:** Allows you to change the transducer, view details about the transducers, and save details to a memory card.

## Sonar Frequencies

**NOTE:** The frequencies available depend on the transducers being used.

Adjusting the frequency helps adapt the sonar for your particular goals and the present depth of the water.

Higher frequencies use narrow beam widths, and are better for high-speed operation and rough sea conditions. Bottom definition and thermocline definition can be better when using a higher frequency.

Lower frequencies use wider beam widths, which can let the fisherman see more targets, but could also generate more surface noise and reduce bottom signal continuity during rough sea conditions. Wider beam widths generate larger arches for fish target returns, making them ideal for locating fish. Wider beam widths also perform better in deep water, because the lower frequency has better deep water penetration.

CHIRP frequencies allow you to sweep each pulse through a range of frequencies, resulting in better target separation in deep water. CHIRP can be used to distinctly identify targets, like individual fish in a school, and for deep water applications. CHIRP generally performs better than single frequency applications. Because some fish targets may show up better using a fixed frequency, you should consider your goals and water conditions when using CHIRP frequencies.

Some transducers also provide the ability to customize preset frequencies for each transducer element, which enables you to change the frequency quickly using the presets as the water and your goals change.

Viewing two frequencies concurrently using the split-frequency view allows you to see deeper with the lower frequency return and, at the same time, see more detail from the higher frequency return.

### NOTICE

Always be aware of local regulations on sonar frequencies. For example, to protect orca whale pods, you might be prohibited from using frequencies between 50 to 80 khz within  $\frac{1}{2}$  mile of an orca whale pod. It is your responsibility to use the device in compliance with all applicable laws and ordinances.

## Selecting the Transducer Frequency

**NOTE:** You cannot adjust the frequency for all sonar views and transducers.

You can select which frequencies appear on the sonar screen.

### NOTICE

Always be aware of local regulations on sonar frequencies. For example, to protect orca whale pods, you might be prohibited from using frequencies between 50 to 80 khz within  $\frac{1}{2}$  mile of an orca whale pod. It is your responsibility to use the device in compliance with all applicable laws and ordinances.

- 1 From a sonar view, select **MENU > Frequency**.
- 2 Select a frequency suited to your needs and water depth.  
For more information on frequencies, see [Sonar Frequencies, page 49](#).

## Creating a Frequency Preset

**NOTE:** Not available with all transducers.

You can create a preset to save a specific sonar frequency, which allows you to change frequencies quickly.

- 1 From a sonar view, select **MENU > Frequency**.
- 2 Select **Manage Frequencies > New Preset**.
- 3 Enter a frequency.

## Turning On the A-Scope

**NOTE:** This feature is available in the Traditional sonar views.

The a-scope is a vertical flasher along the right side of the view, showing you what is underneath the transducer right now. You can use the a-scope to identify target returns that may be missed when the sonar data is quickly scrolling across the screen, such as when your boat is moving at high speeds. It can also be helpful for detecting fish that are close to the bottom.

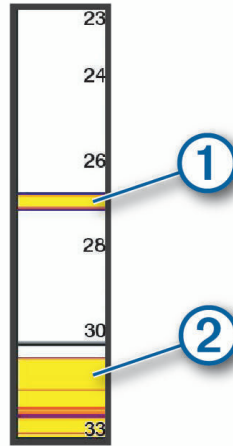

The a-scope above shows fish returns ① and a soft bottom return ②.

- 1 From a sonar view, select **MENU > Sonar Setup > Appearance > A-Scope**.
- 2 If necessary, select **••• > Peak Hold** to adjust the length of time the sonar returns are displayed.

## Sailing Features

### Setting the Vessel Type for Sailing Features

You must select a sailing vessel type to use the sailing features.

- 1 Select **⚙ > My Vessel > Vessel Type**.
- 2 Select **Sailboat** or **Sailing Catamaran**.

### Sail Racing

You can use the device to increase the likelihood that your boat will cross the start line of a race exactly when the race begins. When you synchronize the race timer with the official race countdown timer, you are alerted at one-minute intervals as the race start approaches. When you combine the race timer with the virtual start line, the device measures your speed, bearing, and remaining time on the countdown timer. The device uses this data to indicate whether your boat will cross the start line before, after, or at the correct time to start the race.



## Starting Line Guidance

Sailing start line guidance is a visual representation of the information you need to cross the start line at the optimal time and speed.

After you set the starboard and port start line pins, and the target speed and time, and after you start the race timer, a predictor line appears. The predictor line extends from your current location toward the start line and the laylines that extend from each pin.

The end point and color of the predictor line indicate where the boat will be when the timer expires, based on your current boat speed.

When the end point is before the start line, the line is white. This indicates the boat must increase speed to reach the start line on time.

When the end point is past the start line, the line is red. This indicates the boat must reduce speed to avoid a penalty for reaching the start line before the timer expires.

When the end point is on the start line, the line is white. This indicates the boat is moving at an optimal speed to reach the start line when the timer expires.

By default, the start line guidance window and the race timer window appear in the Sail Racing combination screen.

## Setting the Starting Line

The start line guidance window is added to the Sail Racing combination screen by default.

- 1 From the Sail Racing combination screen, select **MENU > Start Line Guidance > Start Line**.
- 2 Select an option:
  - To mark the port and starboard starting line marks as you sail past them, select **Ping Marks**.
  - To mark the port and starboard starting line marks by entering their coordinates, select **Enter Coordinates**.
  - To switch the position of the port and starboard marks after you have set them, select **Swap Port & Starbd..**

## Using the Starting Line Guidance

You can use the starting line guidance feature to help get you cross the start line, at the optimal speed during a sailing race.

- 1 Mark the starting linexxx.
- 2 From the Sail Racing combination screen, select **MENU > Start Line Guidance > Target Speed**, and select your target speed when crossing the starting line.
- 3 Select **Target Time**, and select the target time to cross the starting line.
- 4 Select **BACK**.
- 5 Start the racing timer (*Starting the Race Timer, page 51*).

## Starting the Race Timer

The race timer is added to the Sail Racing combination screen by default.

- 1 From the Sail Racing combination screen, select **Start**.  
**NOTE:** You can also access this from the Sailing SmartMode™ screen and the navigation chart.
- 2 When necessary, select **Sync** to synchronize with the official race timer.

## Stopping the Race Timer

From the Sail Racing combination screen, select **Stop**.

## Setting the Distance between the Bow and the GPS Antenna

You can enter the distance between the bow of your boat and the location of your GPS antenna. This helps ensure the bow of your boat crosses the starting line at the precise start time.

- 1 From the Sail Racing combination screen, select **MENU > Start Line Guidance > Start Line > GPS Bow Ofst..**
- 2 Enter the distance.
- 3 Select **Done**.

## Laylines Settings

To use the laylines features, you must connect a wind sensor to the chartplotter.

When in sailing mode, you can display laylines on the navigation chart. Laylines can be very helpful when racing.

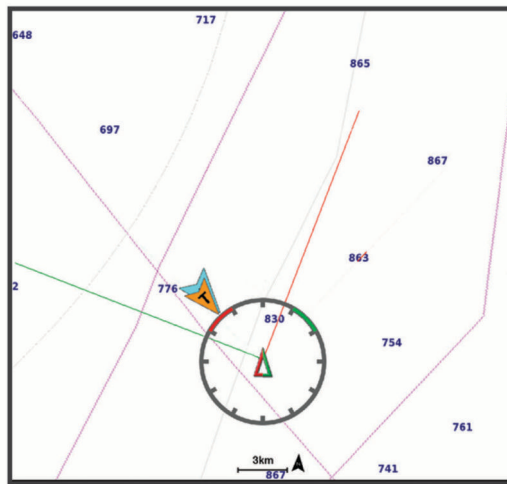

From the Navigation chart, select **MENU > Layers > My Vessel > Laylines > Setup**.

**Sailing Ang.:** Allows you to select how the device calculates laylines. The Actual option calculates the laylines using the measured wind angle from the wind sensor. The Manual option calculates the laylines using manually entered windward and leeward angles. The Polar Table option calculates the laylines based on the imported polar table data.

**Windward Ang.:** Allows you to set a layline based on the windward sailing angle.

**Leeward Ang.:** Allows you to set a layline based on the leeward sailing angle.

**Tide Correction:** Corrects the laylines based on the tide.

**Layline Filter:** Filters the layline data based on the time interval entered. For a smoother layline that filters out some of the changes in the boat's heading or true wind angle, enter a higher number. For laylines that display a higher sensitivity to changes in the boat's heading or true wind angle, enter a lower number.

## Polar Tables

### ⚠ WARNING

This feature allows you to load and use data from a third party. Garmin makes no representations about the accuracy, reliability, completeness or timeliness of the data generated by third parties. Any use or reliance on data generated by third parties is at your own risk.

You can use polar table data with your chartplotter. You can assign polar data types in data fields, and you can use polar data to calculate optimal laylines and starting line guidance.

## Importing a Polar Table Manually

If you save the polar table file as polar.plr and place it in the Garmin/polars/ folder on the memory card, the chartplotter imports the data automatically after you insert the memory card. If it does not import the data automatically, or if you want to load a different set of data, you can initiate the import manually.

- 1 Save the polar table as a .plr file in the Garmin/polars/ folder on the memory card.
- 2 Insert the memory card containing the polar data file into the chartplotter (*Inserting Memory Cards, page 4*).
- 3 Select  > **My Vessel** > **Polar Table** > **Import from Card**.
- 4 If necessary, select the card slot and the polar table file.

After the polar table is imported, you can remove the memory card.

If you need to import a different set of polar tables based on your sailing plans or conditions, you must manually import the new polar-table data. The chartplotter supports one set of data at a time.

## Showing Polar Data in Data Fields

Before you can view polar data, you must import a polar table from a memory cardxxx.

- 1 Open the screen to which you want to add polar data.
- 2 Select **MENU** > **Edit Overlays**.
- 3 Select the data field to change.
- 4 Select **Sailing**.
- 5 Select the polar data to display in the data field.
  - To show the boat speed from the polar table at the current true wind speed and angle, select **Polar Speed**.
  - To show the optimal boat speed at the target wind angle, select **Target Speed**.
  - To show the optimal wind angle at the current true wind speed, select **Target True Wind Angle**.
  - To show Target TWA converted to apparent using target speed, select **Target App. Wind Angle**.
  - To show the difference between the current boat speed and the optimal boat speed shown as speed, select **Δ Polar Speed**.
  - To show the difference between the current boat speed and the optimal boat speed as a percentage, select **Δ Polar Speed Percent**.
  - To show the difference between the current boat speed and the target boat speed shown as speed, select **Δ Target Speed**.
  - To show the difference between the current boat speed and the target boat speed shown as a percentage, select **Δ Target Speed Percent**.
  - To show the difference between the true wind angle and target true wind angle, select **Δ Target True Wind Angle**.
  - To show the difference between the apparent wind angle and target apparent wind angle and the true wind angle, select **Δ Target App. Wind Angle**.

**TIP:** You can also use the polar table data when calculating laylines and starting line guidance.

## Setting the Keel Offset

You can enter a keel offset to compensate the water depth reading for the transducer installation location. This allows you to view the depth of the water below the keel or the true depth of the water, depending on your needs.

If you want to know the water depth below the keel or the lowest point of your boat and the transducer is installed at the water line or anywhere above the end of the keel, measure the distance from the transducer location to the keel of the boat.

If you want to know the true water depth and the transducer is installed below the water line, measure the distance from the bottom of the transducer up to the water line.

**NOTE:** This option is only available when you have valid depth data.

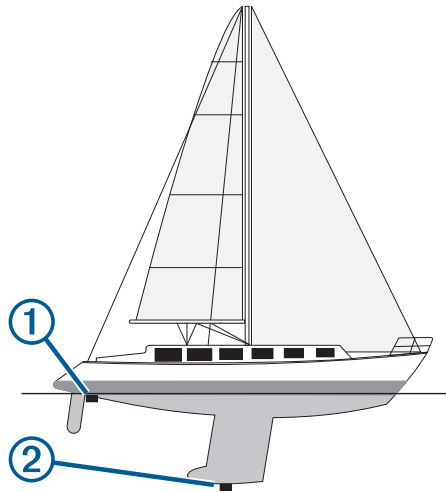

1 Measure the distance:

- If the transducer is installed at the water line ① or anywhere above the end of the keel, measure the distance from the transducer location to the keel of the boat. Enter this value as a positive number.
- If the transducer is installed at the bottom of the keel ② and you want to know the true depth of the water, measure the distance from the transducer to the water line. Enter this value in as a negative number.



2 Complete an action:

- If the transducer is connected to the chartplotter or a sonar module, select  > **My Vessel > Keel Offset**.

3 Select  if the transducer is installed at the water line, or select  if the transducer is installed at the bottom of the keel.

4 Use the arrow keys to enter the keel offset measured in step 1.

## Heading Line and Angle Markers

The heading line is an extension drawn on the map from the bow of the boat in the direction of travel. Angle markers indicate relative position from the heading or course over ground, which are helpful for casting or finding reference points.

## Setting the Heading Line and Angle Markers

The heading line is an extension drawn on the map from the bow of the boat in the direction of travel. Angle markers indicate relative position from the heading or course over ground, which are helpful for casting or finding reference points.

You can show the heading line and the course over ground (COG) line on the chart.

COG is your direction of movement. Heading is the direction the bow of the boat is pointed, when a heading sensor is connected.

- 1 From a chart, select **MENU > Layers > My Vessel > Heading Line > Angle Markers**.
- 2 If necessary, select **Source**, and select an option:
  - To automatically use the available source, select **Auto**.
  - To use the GPS antenna heading for COG, select **GPS Heading (COG)**.
  - To use data from a connected heading sensor, select **Heading**.
  - To use data from both a connected heading sensor and the GPS antenna, select **COG and Heading**.  
This displays both the heading line and the COG line on the chart.
- 3 Select **Display**, and select an option:
  - Select **Distance > Distance**, and enter the length of the line shown on the chart.
  - Select **Time > Time**, and enter the time used to calculate the distance your boat will travel in the specified time at your present speed.

## Viewing Sailing Vessel Data

After you have connected a compatible device, such as the MSC™ 10 compass, you can view vessel data, such as heave, pitch, and heel.

- 1 Select an option based on the type of screen you are viewing:
  - From a full screen view, select **MENU > Edit Overlays**.
  - From a combination screen, select **MENU > Edit Combo > Overlays**.
- 2 Select **Data**.
- 3 Select the data to add to the page, such as **Heave, Trim (Pitch), or Heel Angle**.

## Gauges and Graphs

The gauges and graphs provide various information about the engine and environment. To view the information, a compatible transducer or sensor must be connected to the network.

## Viewing the Gauges

- 1 Select **Vessel**.
- 2 Select a gauge, such as **Vessel**.

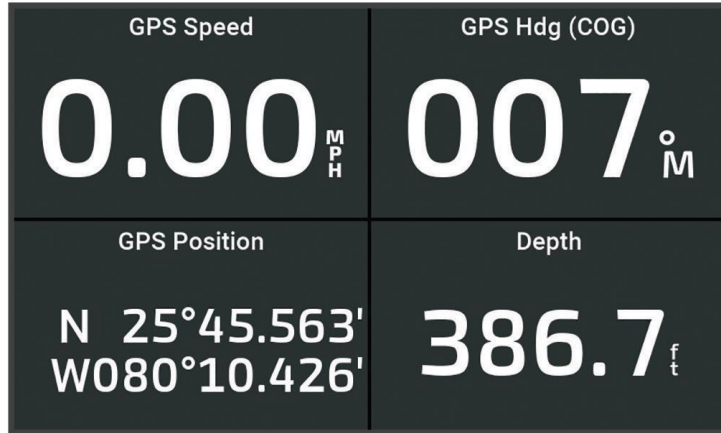

## Changing the Data Shown in a Gauge

- 1 Open a gauge page.
- 2 Select **MENU > Edit Gauge Pages**.
- 3 Select a gauge to edit.
- 4 Select **Replace Data**.
- 5 Select a data type.
- 6 Select the data to display.

## Customizing the Gauges

You can add a gauge page, change the layout of the gauge page, change how the gauges are displayed, and change the data in each gauge.

- 1 Open a gauge page.
- 2 Select **MENU > Edit Gauge Pages**.
- 3 If necessary, select a gauge view or gauge to edit.
- 4 Select an option:
  - To change the data shown in a gauge, select the gauge and select **Replace Data**.
  - To change the layout of the gauges on the page, select **Change Layout**.
  - To add a page to this set of gauge pages, select **Add Page**.
  - To restore this page to the original view, select **Restore Default View**.

## Viewing Trip Gauges

Trip gauges show information for odometer, speed, time, and fuel for your present trip.

Select **◀ > Trip & Graphs > Trip**.

## Resetting Trip Gauges

- 1 Select  > **Trip & Graphs** > **Trip**.
- 2 Select an option:
  - To set all the readings for the present trip to zero, select **Reset Trip**.
  - To set the maximum speed reading to zero, select **Reset Maximum Speed**.
  - To set the odometer reading to zero, select **Reset Odometer**.
  - To set all the readings to zero, select **Reset All**.

## Viewing Graphs

Before you can view graphs of various environmental changes, such as temperature and depth, you must have an appropriate transducer connected to the device.

Select  > **Trip & Graphs** > **Graphs**.

**TIP:** You can view different available graphs by selecting Change Graph, and selecting a new graph.

## Setting the Graph Range and Time Scales

You can indicate the amount of time and the range of sensor data that appears in the depth, wind, and water temperature graphs.

- 1 From a graph, select **Graph Setup**.
- 2 Select an option:
  - To set a time-elapsed scale, select **Duration**. The default setting is 10 minutes. Increasing the time-elapsed scale allows you to view variations over a longer period of time. Decreasing the time-elapsed scale allows you to view more detail over a shorter period of time.
  - To set the graph scale, select **Scale**. Increasing the scale allows you to view more variation in readings. Decreasing the scale allows you to view more detail in the variation.

## Warning Manager

The Warning Manager displays a color-coded alarm icon and prioritizes alarm messages by severity.

To open the Warning Manager, select  > **Warning Manager**.

Color	Severity
Red	Hazards that require immediate action to avoid severe personal injury or death
Yellow	Hazards or unsafe practices which could result in minor personal injury or product or property damage

## Viewing Messages

- 1 Select  > **Warning Manager**.
- 2 Select a message.
- 3 Select **Review**.

## Sorting and Filtering Messages

- 1 Select  > **Warning Manager** > **Sort/Filter**.
- 2 Select an option to sort or filter the message list.

## Saving Messages to a Memory Card

- 1 Insert a memory card into the card slot.
- 2 Select  > **Warning Manager** > **Save to Card**.



## Clearing All of the Messages

Select  > **Warning Manager** > **Clear Warning Manager**.

# Device Configuration

## System Settings

Select  > **System**.

**Sounds and Display:** Adjusts the display settings and the audio settings (if available).

**Satellite Positioning:** Provides information about the GPS satellites and settings.

**System Information:** Provides information about the devices on the network and the software version.

**Auto Power Up:** Controls which devices turn on automatically when power is applied.

**Auto Power Off:** Automatically turns off the system after it has been asleep for the selected length of time.

**Simulator:** Turns the simulator on or off and allows you to set the time, date, speed, and simulated location.

## Sounds and Display Settings

Select  > **System** > **Sounds and Display**.

**Beeper:** Turns on and off the tone that sounds for alarms and selections.

**Audio Setup:** Sets up the audio output.

**Backlight:** Sets the backlight brightness. You can select the Auto option to adjust the backlight brightness automatically based on the ambient light.

**Color Mode:** Sets the device to display day or night colors. You can select the Auto option to allow the device to set day or night colors automatically based on the time of day.

**Startup Image:** Sets the image that appears when you turn on the device.

**Startup Layout:** Sets the layout that appears when you turn on the device.

## Satellite Positioning (GPS) Settings

Select  > **System** > **Satellite Positioning**.

**Skyview:** Shows the relative position of GPS satellites in the sky.

**GLONASS:** Turns on or off GLONASS data (Russia satellite system). When the system is used in situations with poor sky visibility, GLONASS data can be used in combination with GPS to provide more accurate position information.

**WAAS/EGNOS:** Turns on or off WAAS data (in North America) or EGNOS data (in Europe), which can provide more-accurate GPS position information. When using WAAS or EGNOS data, the device may take longer to acquire satellites.

**Galileo:** Turns on or off Galileo data (European Union satellite system). When the system is used in situations with poor sky visibility, Galileo data can be used in combination with GPS to provide more accurate position information.

**Speed Filter:** Averages the speed of your vessel over a short period of time for smoother speed values.

**Source:** Allows you to select the preferred source for GPS data.

## Viewing System Software Information

You can view the software version, the basemap version, all supplemental map information (if applicable), and the unit ID number. You may need this information to update the system software or to purchase additional map data information.

Select  > **System** > **System Information** > **Software Information**.

## Viewing the Event Log

The event log shows a list of system events.

Select  > **System** > **System Information** > **Event Log**.

## Viewing E-label Regulatory and Compliance Information

The label for this device is provided electronically. The e-label may provide regulatory information, such as identification numbers provided by the FCC or regional compliance markings, as well as applicable product and licensing information. Not available on all models.

- 1 Select .
- 2 Select **System**.
- 3 Select **Regulatory Information**.

## Preferences Settings

Select  > **Preferences**.

**Units:** Sets units of measure.

**Language:** Sets the on-screen text language.

**Navigation:** Sets navigation preferences.

**Keyboard Layout:** Arranges the keys on the on-screen keyboard.

**Screenshot Capture:** Allows the device to save images of the screen.

## Units Settings

Select  > **Preferences** > **Units**.

**System Units:** Sets the unit format for the device. For example, **Custom** > **Depth** > **Fathoms** sets the unit format for depth to Fathoms.

**Variance:** Sets the magnetic declination, the angle between magnetic north and true north, for your present location.

**North Reference:** Sets the direction references used in calculating heading information. True sets geographic north as the north reference. Grid sets grid north as the north reference (000°). Magnetic sets the magnetic north as the north reference.

**Position Format:** Sets the position format in which a given location reading appears. Do not change this setting unless you are using a map or chart that specifies a different position format.

**Map Datum:** Sets the coordinate system on which the map is structured. Do not change this setting unless you are using a map or chart that specifies a different map datum.

**Time:** Sets the time format, time zone, and daylight saving time.

## Navigation Settings

**NOTE:** Some settings and options require additional charts or hardware.

Select  > **Preferences** > **Navigation**.

**Route Labels:** Sets the type of labels shown with route turns on the map.

**Turn Transition:** Adjusts how the chartplotter transitions to the next turn or leg or the route. You can set the transition to be based on time or distance before the turn. You can increase the time or distance value to help improve the accuracy of the autopilot when navigating a route or an Auto Guidance line with many frequent turns or at higher speeds. For straighter routes or slower speeds, lowering this value can improve autopilot accuracy.

**Speed Sources:** Sets the source for the speed readings.

**Auto Guidance:** Sets the measurements for the Preferred Depth, Vertical Clearance, and Shoreline Distance, when you are using some premium maps.

**Route Start:** Selects a starting point for route navigation.

## Auto Guidance Path Configurations

### CAUTION

The Preferred Depth and Vertical Clearance settings influence how the chartplotter calculates an Auto Guidance path. If a section of an Auto Guidance path is shallower than the Preferred Depth or lower than the Vertical Clearance settings, the section of the Auto Guidance path appears as a solid orange line or a red striped line in Garmin Navionics+ and Garmin Navionics Vision+ charts and appears as a magenta and gray striped line in previous versions. When your boat enters one of those areas, a warning message appears ([Route Color Coding, page 27](#)).

---

**NOTE:** Auto Guidance is available with premium charts, in some areas.

**NOTE:** Not all settings apply to all maps.

You can set the parameters the chartplotter uses when calculating an Auto Guidance path.

Select  > **Preferences** > **Navigation** > **Auto Guidance**.

**Preferred Depth:** Sets the minimum water depth, based on chart depth data, that your boat can safely travel over.



**NOTE:** The minimum water depth for the premium charts (made before 2016) is 3 feet. If you enter a value of less than 3 feet, the charts only use depths of 3 feet for Auto Guidance path calculations.



**Vertical Clearance:** Sets the minimum height of a bridge or obstacle, based on chart data, that your boat can safely travel under.

**Shoreline Distance:** Sets how close to the shore you want the Auto Guidance path to be placed. The path may move if you change this setting while navigating. The available values for this setting are relative, not absolute. To ensure that path is placed the appropriate distance from shore, you can assess the placement of the path using one or more familiar destinations that require navigation through a narrow waterway ([Adjusting the Distance from Shore, page 36](#)).

## Adjusting the Distance from Shore

The Shoreline Distance setting indicates how close to the shore you want the Auto Guidance line to be placed. The Auto Guidance line may move if you change this setting while navigating. The available values for the Shoreline Distance setting are relative, not absolute. To ensure the Auto Guidance line is placed the appropriate distance from shore, you can assess the placement of the Auto Guidance line using one or more familiar destinations that require navigation through a narrow waterway.

- 1 Dock your vessel or drop the anchor.
- 2 Select  > **Preferences > Navigation > Auto Guidance > Shoreline Distance > Normal**.
- 3 Select a destination that you have navigated to previously.
- 4 Select **Navigate To > Auto Guidance**.
- 5 Review the placement of the **Auto Guidance** line, and determine whether the line safely avoids known obstacles and the turns enable efficient travel.
- 6 Select an option:
  - If the placement of the line is satisfactory, select **MENU > Navigation Options > Stop Navigation**, and proceed to step 10.
  - If the line is too close to known obstacles, select  > **Preferences > Navigation > Auto Guidance > Shoreline Distance > Far**.
  - If the turns in the line are too wide, select  > **Preferences > Navigation > Auto Guidance > Shoreline Distance > Near**.
- 7 If you selected **Near** or **Far** in step 6, review the placement of the **Auto Guidance** line, and determine whether the line safely avoids known obstacles and the turns enable efficient travel.

Auto Guidance maintains a wide clearance from obstacles in open water, even if you set the Shoreline Distance setting to Near or Nearest. As a result, the chartplotter may not reposition the Auto Guidance line, unless the destination selected requires navigation through a narrow waterway.
- 8 Select an option:
  - If the placement of the line is satisfactory, select **MENU > Navigation Options > Stop Navigation**, and proceed to step 10.
  - If the line is too close to known obstacles, select  > **Preferences > Navigation > Auto Guidance > Shoreline Distance > Farthest**.
  - If the turns in the line are too wide, select  > **Preferences > Navigation > Auto Guidance > Shoreline Distance > Nearest**.
- 9 If you selected **Nearest** or **Farthest** in step 8, review the placement of the **Auto Guidance** line, and determine whether the line safely avoids known obstacles and the turns enable efficient travel.

The Auto Guidance path maintains a wide clearance from obstacles in open water, even if you set the Shoreline Distance setting to Near or Nearest. As a result, the chartplotter may not reposition the Auto Guidance line, unless the destination selected requires navigation through a narrow waterway.
- 10 Repeat steps 3 through 9 at least once more, using a different destination each time, until you are familiar with the functionality of the **Shoreline Distance** setting.

# Communications Settings

## Viewing Connected Devices

You can view lists of the connected devices on the vessel including which chartplotter a device is connected to or paired with.

- 1 Select  > **Communications**.
- 2 Select a network.
- 3 Select **Device List**.

A list of network devices appears. If a device is connected to or paired with a specific chartplotter, the name of the chartplotter is shown along with the device name.

**NOTE:** Some devices included in the NMEA 2000® device list may be connected to a chartplotter at another station on the vessel. You can select **Related To:** to see more information about which chartplotter the device is connected to.

## Setting Alarms

### CAUTION

The Beeper setting must be turned on to make alarms audible (*Sounds and Display Settings, page 58*). Failure to set audible alarms could lead to injury or property damage.

## Navigation Alarms

Select  > **Alarms** > **Navigation**.

**Arrival:** Sets an alarm to sound when you are within a specified distance or time from a turn or a destination.

**Anchor Drag:** Sets an alarm to sound when you exceed a specified drift distance while anchored.

**Off Course:** Sets an alarm to sound when you are off course by a specified distance.

**Boundary Alarms:** Disables and enables all boundary alarms.

## Setting the Anchor Drag Alarm

You can set an alarm to sound if you have moved outside an allowable radius you set when configuring the alarm.

### WARNING

The anchor drag alarm is a tool for situational awareness only, and may not prevent grounding or collisions in all circumstances. You are responsible for the safe and prudent operation of your vessel, for remaining aware of your surroundings, and for using safe judgement on the water at all times. Failure to heed this warning could result in property damage, serious personal injury, or death.

### CAUTION

The Beeper setting must be turned on to make alarms audible (*Sounds and Display Settings, page 58*). Failure to set audible alarms could lead to injury or property damage.

- 1 Select  > **Alarms** > **Navigation** > **Anchor Drag**.
- 2 Select **Alarm** to turn on the alarm.
- 3 Select **Set Radius**, and select a distance on the chart.
- 4 Select **BACK**.

## System Alarms

Select  > **Alarms** > **System**.

**Unit Voltage:** Sets an alarm to sound when the battery reaches a specified low voltage.

**GPS Accuracy:** Sets an alarm to sound when the GPS location accuracy falls outside the user-defined value.

## Sonar Alarms

### **WARNING**

The sonar alarms feature is a tool for situational awareness only and may not prevent grounding in all circumstances. It is your obligation to ensure safe operation of the vessel.

### **CAUTION**

The Beeper setting must be turned on to make alarms audible (*Sounds and Display Settings, page 58*). Failure to set audible alarms could lead to injury or property damage.

**NOTE:** Not all options are available on all transducers.

From an applicable sonar view, select **MENU** > **Sonar Setup** > **Alarms**.

You can also open the sonar alarms by selecting  > **Alarms** > **Sonar**.



**Shallow Water:** Sets an alarm to sound when the depth is less than the specified value.

**Deep Water:** Sets an alarm to sound when the depth is greater than the specified value.

**Water Temp.:** Sets an alarm to sound when the transducer reports a temperature that is 2°F (1.1°C) above or below the specified temperature.

**Contour:** Sets an alarm to sound when the transducer detects a suspended target within the specified depth from the surface of the water and from the bottom.

**Fish:** Sets an alarm to sound when the device detects a suspended target.

-  sets the alarm to sound when fish of all sizes are detected.
-  sets the alarm to sound only when medium or large fish are detected.
-  sets the alarm to sound only when large fish are detected.

## My Vessel Settings

**NOTE:** Some settings and options require additional charts or hardware.

Select  > **My Vessel**.

**Transducers:** Shows all transducers on the network, allows you to change transducers, and allows you to view diagnostic information (*Selecting the Transducer Type, page 43*).

**Temp. Offset:** Allows you to set an offset value to compensate for the water temperature reading from a NMEA® 0183 water-temperature sensor or a temperature-capable transducer (*Setting the Water Temperature Offset, page 64*).

**Hull ID Number:** Allows you to enter the Hull Identification Number (HIN). The HIN might be permanently affixed to the upper starboard side of the transom or outboard side.

## Setting the Keel Offset

You can enter a keel offset to compensate the water depth reading for the transducer installation location. This allows you to view the depth of the water below the keel or the true depth of the water, depending on your needs.

If you want to know the water depth below the keel or the lowest point of your boat and the transducer is installed at the water line or anywhere above the end of the keel, measure the distance from the transducer location to the keel of the boat.

If you want to know the true water depth and the transducer is installed below the water line, measure the distance from the bottom of the transducer up to the water line.

**NOTE:** This option is only available when you have valid depth data.

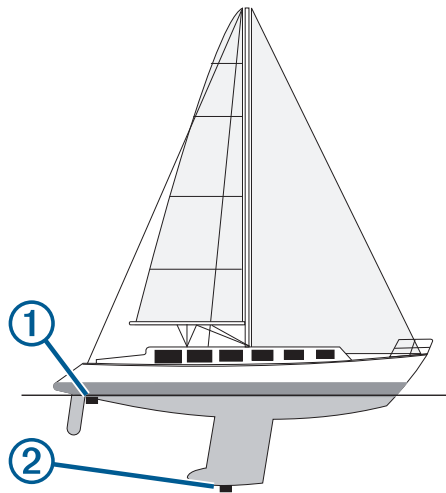

1 Measure the distance:

- If the transducer is installed at the water line ① or anywhere above the end of the keel, measure the distance from the transducer location to the keel of the boat. Enter this value as a positive number.
- If the transducer is installed at the bottom of the keel ② and you want to know the true depth of the water, measure the distance from the transducer to the water line. Enter this value in as a negative number.



2 Complete an action:

- If the transducer is connected to the chartplotter or a sonar module, select  > **My Vessel > Keel Offset**.

3 Select  if the transducer is installed at the water line, or select  if the transducer is installed at the bottom of the keel.

4 Use the arrow keys to enter the keel offset measured in step 1.

## Setting the Water Temperature Offset

The temperature offset compensates for the temperature reading from a temperature sensor or temperature-capable transducer.

1 Measure the water temperature using the temperature sensor or temperature-capable transducer that is connected to the network.

2 Measure the water temperature using a different temperature sensor or a thermometer that is known to be accurate.

3 Subtract the water temperature measured in step 1 from the water temperature measured in step 2.

This value is the temperature offset. Enter this value in step 5 as a positive number if the sensor measures the water temperature as being colder than it actually is. Enter this value in step 5 as a negative number if the sensor measures the water temperature as being warmer than it actually is.

4 Select  > **My Vessel > Temp. Offset**.

5 Enter the temperature offset value calculated in step 3.



## Restoring the Original Chartplotter Factory Settings

**NOTE:** This affects all devices on the network.

- 1 Select  > **System** > **System Information** > **Reset**.
- 2 Select an option:
  - To reset the device settings to the factory default values, select **Reset Default Settings**. This restores the default configuration settings, but does not remove saved user data, maps, or software updates.
  - To clear saved data, such as waypoints and routes, select **Delete User Data**. This does not affect maps or software updates.
  - To clear saved data and reset device settings to the factory default values, disconnect the chartplotter from the Garmin Marine Network, and select **Delete Data and Reset Settings**. This does not affect maps or software updates.

## Sharing and Managing User Data

### **WARNING**

This feature allows you to import data from other devices that may have been generated by third parties. Garmin makes no representations about the accuracy, completeness, or timeliness of data that is generated by third parties. Any reliance on or use of such data is at your own risk.

You can share user data between compatible devices. User data includes waypoints, saved tracks, routes, and boundaries.

- You can share and manage user data using a memory card. You must have a memory card installed in the device. This device supports up to a 32 GB memory card, formatted to FAT32.

## Selecting a File Type for Third-Party Waypoints and Routes

You can import and export waypoints and routes from third-party devices.

- 1 Insert a memory card into the card slot.
- 2 Select  > **Manage User Data** > **Data Transfer** > **File Type**.
- 3 Select **GPX**.

To transfer data with Garmin devices again, select the ADM file type.

## Copying User Data from a Memory Card

You can transfer user data from a memory card to transfer from other devices.

- 1 Insert a memory card into a card slot.
- 2 Select  > **Manage User Data** > **Data Transfer**.
- 3 If necessary, select the memory card to copy data to.
- 4 Select an option:
  - To transfer data from the memory card to the chartplotter and combine it with existing user data, select **Merge from Card**.
  - To transfer data from the memory card to the chartplotter and overwrite existing user data, select **Replace from Card**.
- 5 Select the file name.

## Copying All User Data to a Memory Card

You can save all of the user data on the device to a memory card to transfer to other devices.

- 1 Insert a memory card into the card slot.
- 2 Select **◀ > Manage User Data > Data Transfer > Save All to Card**.
- 3 If necessary, select the memory card to copy the data to.
- 4 Select an option:
  - To create a new file, select **Add New File**, and enter a name.
  - To add the information to an existing file, select the file from the list, and select **Save to Card**.

## Copying User Data from a Specified Area to a Memory Card

You can save user data from a specified area to a memory card to transfer to other devices.

- 1 Insert a memory card into the card slot.
- 2 Select **◀ > Manage User Data > Data Transfer > Save Area to Card**.
- 3 Select an option:
  - If you previously defined an area boundary containing user data you want to transfer, select the name of the area and select **Select Area**.
  - If you want to define a new area containing user data to transfer, select **New Area**, and follow the on-screen instructions to define the area.
- 4 Select **Save Area to Card**.
- 5 If necessary, select the memory card to copy the data to.
- 6 Select an option:
  - To create a new file, select **Add New File**, and enter a name.
  - To add the information to an existing file, select the file from the list, and select **Save to Card**.

## Updating Built-In Maps with a Memory Card and Garmin Express

You can update the built-in maps using the Garmin Express computer application and a memory card.

- 1 Insert a memory card into the computer's card slot (*Inserting Memory Cards, page 4*).
- 2 Open the Garmin Express application.

If you do not have the Garmin Express application installed on your computer, you can download it from [garmin.com/express](http://garmin.com/express).
- 3 If necessary, register your device (*Registering Your Device Using the Garmin Express App, page 69*).
- 4 Click **Vessel > View Details**.
- 5 Click **Download** next to the map to update.
- 6 Follow the on-screen instructions to complete the download.
- 7 Wait while the update downloads.

The update may take an extended period of time.
- 8 After the download is complete, eject the card from the computer.
- 9 Insert the memory card into the card slot (*Inserting Memory Cards, page 4*).
- 10 On the chartplotter, select **⚙ > System > System Information > Update Built-In Map**.

The updated chart appears on your chartplotter.

## Backing Up Data to a Computer

- 1 Insert a memory card into the card slot.
- 2 Select  > **Manage User Data** > **Data Transfer** > **Save to Card**.
- 3 Select a file name from the list, or select **Add New File**.
- 4 Select **Save to Card**.
- 5 Remove the memory card, and insert it into a card reader attached to a computer.
- 6 Open the Garmin\UserData folder on the memory card.
- 7 Copy the backup file on the card and paste it to any location on the computer.

## Restoring Backup Data to a Chartplotter

- 1 Insert a memory card into a card reader that is attached to the computer.
- 2 Copy a backup file from the computer to the memory card, into a folder named Garmin\UserData.
- 3 Insert a memory card into the card slot.
- 4 Select  > **Manage User Data** > **Data Transfer** > **Replace from Card**.

## Saving System Information to a Memory Card

You can save system information to a memory card as a troubleshooting tool. A product support representative may ask you to use this information to retrieve data about the network.

- 1 Insert a memory card into the card slot.
- 2 Select  > **System** > **System Information** > **Garmin Devices** > **Save to Card**.
- 3 If necessary, select the memory card to save system information to.
- 4 Remove the memory card.

# Appendix

## ActiveCaptain and Garmin Express

The ActiveCaptain and Garmin Express apps help you manage your Garmin chartplotter and other devices.

**ActiveCaptain:** The ActiveCaptain mobile app provides an easy-to-use connection between your compatible mobile device and your compatible Garmin chartplotter, charts, and the Garmin Quickdraw Contours Community (*ActiveCaptain® App, page 8*). The app provides unlimited access to your cartography and a quick, mobile way to download new charts using the OneChart™ feature, provides a link to receive notifications on your chartplotter, and provides access to the ActiveCaptain Community for feedback on marinas and other boating points of interest. You can also use the app to plan your trip and sync user data. The app checks your devices for available updates, and notifies you when an update is available.

**Garmin Express:** The Garmin Express desktop app allows you to use your computer and a memory card to download and update Garmin chartplotter software and charts (*Garmin Express App, page 68*). You should use the Garmin Express app for faster data transfer of larger downloads and updates, and to avoid possible data charges with some mobile devices.

Function	ActiveCaptain mobile app	Garmin Express desktop app
Register your new Garmin Marine device	Yes	Yes
Update your Garmin chartplotter software	Yes	Yes
Update your Garmin charts	Yes	Yes
Download new Garmin charts	Yes	Yes
Access the Garmin Quickdraw Contours Community to download and share contours with other users	Yes	No
Sync a mobile device with your Garmin chartplotter	Yes	No
Access the ActiveCaptain Community for feedback on marinas and boating points of interest	Yes	No

## Garmin Express App

The Garmin Express desktop app allows you to use your computer and a memory card to download and update Garmin device software and charts and register your devices. We recommend it for larger downloads and updates for faster data transfer and to avoid possible data charges with some mobile devices.

### Installing the Garmin Express App on a Computer

You can install the Garmin Express app on a Windows® or Mac® computer.

- 1 Go to [garmin.com/express](http://garmin.com/express).
- 2 Select **Download for Windows** or **Download for Mac**.
- 3 Follow the on-screen instructions.

## Registering Your Device Using the Garmin Express App

**NOTE:** You should use the ActiveCaptain app and a mobile device to register the device (*Getting Started with the ActiveCaptain App*, page 9).

Help us better support you by completing our online registration today. Keep the original sales receipt, or a photocopy, in a safe place.

1 Install the Garmin Express app on your computer (*Installing the Garmin Express App on a Computer*, page 68).

2 Insert a memory card into the card slot (*Inserting Memory Cards*, page 4).

3 Wait a few moments.

The chartplotter opens the card management page and creates a file named GarminDevice.xml in the Garmin folder on the memory card.

4 Remove the memory card from your device.

5 Open the Garmin Express app on your computer.

6 Insert the memory card into your computer.

7 If necessary, select **Get Started**.

8 If necessary, while the application searches, select **Sign In** next to **Have marine charts or devices?** near the bottom of the screen.

9 Create or sign in to your Garmin account.

10 Follow the on-screen instructions to set up your vessel.

11 Select **+** > **Add**.

The Garmin Express application searches the memory card for the device information.

12 Select **Add Device** to register the device.

When registration is complete, the Garmin Express application searches for additional charts and chart updates for your device.

When you add devices to the chartplotter network, repeat these steps to register the new devices using the Garmin Express app.

## Updating Your Charts Using the Garmin Express App

This device supports up to a 32 GB microSD memory card, formatted to FAT32 with speed class 4 or higher. Use of an 8 GB or larger memory card with speed class 10 is recommended.

Downloading the chart update may take up to a few hours.

You should use a blank memory card for chart updates. The update process erases the content on the card and reformats the card.

- 1 Install the Garmin Express app on your computer (*Installing the Garmin Express App on a Computer, page 68*).
- 2 Open the Garmin Express app on your computer.
- 3 Select your vessel and device.
- 4 If chart updates are available, select **Chart Updates > Continue**.
- 5 Read and agree to the terms.
- 6 Insert your chartplotter chart memory card into the computer.
- 7 Select the drive for the memory card.
- 8 Review the reformat warning, and select **OK**.
- 9 Wait while the chart update is copied to the memory card.  
**NOTE:** Copying the update file onto the card may take from a few minutes up to a few hours.
- 10 Close the Garmin Express app.
- 11 Eject the memory card from the computer.
- 12 Turn on the chartplotter.
- 13 After the home screen appears, insert the memory card into the card slot.  
**NOTE:** In order for the update instructions to appear, the device must be fully booted before the card is inserted.
- 14 Select **Update Software > Yes**.
- 15 Wait several minutes while the update process completes.
- 16 When prompted, leave the memory card in place, and restart the chartplotter.
- 17 Remove the memory card.  
**NOTE:** If the memory card is removed before the device restarts fully, the update is not complete.

## Software Updates

You may need to update the software when you install a new device or add an accessory.

You can use the ActiveCaptain mobile app to update the device software (*Updating Software with the ActiveCaptain App, page 9*).

You can also use the Garmin Express desktop app to update your chartplotter software (*Loading the New Software on a Memory Card Using Garmin Express, page 71*).

This device supports up to a 32 GB microSD memory card, formatted to FAT32 with speed class 4 or higher. Use of an 8 GB or larger memory card with speed class 10 is recommended.

Before you update the software, you should check the software version installed on your device (*Viewing System Software Information, page 58*). Then, you can go to [garmin.com/support/software/marine.html](http://garmin.com/support/software/marine.html), select See All Devices in this Bundle, and compare the installed software version to the software version listed for your product.

If the software version installed on your device is older than the version listed on the website, you should update the software using the ActiveCaptain mobile app (*Updating Software with the ActiveCaptain App, page 9*) or the Garmin Express desktop app (*Loading the New Software on a Memory Card Using Garmin Express, page 71*).

## Loading the New Software on a Memory Card Using Garmin Express

You can copy the software update to a memory card using a computer with the Garmin Express app.

This device supports up to a 32 GB microSD memory card, formatted to FAT32 with speed class 4 or higher. Use of an 8 GB or larger memory card with speed class 10 is recommended.

Downloading the software update may take from a few minutes up to a few hours.

You should use a blank memory card for software updates. The update process erases the content on the card and reformats the card.

- 1 Insert a memory card into the card slot on the computer.
- 2 Install the Garmin Express app (*Installing the Garmin Express App on a Computer, page 68*).
- 3 Select your vessel and device.
- 4 Select **Software Updates > Continue**.
- 5 Read and agree to the terms.
- 6 Select the drive for the memory card.
- 7 Review the reformat warning, and select **Continue**.
- 8 Wait while the software update is copied to the memory card.  
**NOTE:** Copying the update file onto the card may take from a few minutes up to a few hours.
- 9 Close the Garmin Express app.
- 10 Eject the memory card from the computer.

After loading the update onto the memory card, install the software on the chartplotter (*Updating the Device Software Using a Memory Card, page 71*).

## Updating the Device Software Using a Memory Card

To update the software using a memory card, you must obtain a software-update memory card or load the latest software onto a memory card using the Garmin Express app (*Loading the New Software on a Memory Card Using Garmin Express, page 71*).

- 1 Turn on the chartplotter.
- 2 After the home screen appears, insert the memory card into the card slot.  
**NOTE:** In order for the software update instructions to appear, the device must be fully booted before the card is inserted.
- 3 Select **Install Now > Update Software > Yes**.
- 4 Wait several minutes while the software update process completes.
- 5 When prompted, leave the memory card in place, and restart the chartplotter.
- 6 Remove the memory card.  
**NOTE:** If the memory card is removed before the device restarts fully, the software update is not complete.

## Cleaning the Screen

### NOTICE

Cleaners containing ammonia will harm the anti-reflective coating.

The device is coated with a special anti-reflective coating which is very sensitive to waxes and abrasive cleaners.

- 1 Apply an eyeglass lens cleaner specified as safe for anti-reflective coatings to the cloth.
- 2 Gently wipe the screen with a soft, clean, lint-free cloth.

## Viewing Images on a Memory card

You can view images that are saved on a memory card. You can view .jpg, .png, and .bmp files.

- 1 Insert a memory card with image files into the card slot.
- 2 Select  > **Image Viewer**.
- 3 Select the folder containing the images.
- 4 Wait a few seconds for the thumbnail images to load.
- 5 Select an image.
- 6 Use the arrows to scroll through the images.
- 7 If necessary, select **MENU** > **Start Slideshow**.

## Screenshots

You can capture a screenshot of any screen shown on your chartplotter as a .png file. You can transfer the screenshot to your computer.

### Capturing Screenshots

- 1 Insert a memory card into the card slot.
- 2 Select  > **Preferences** > **Screenshot Capture** > **On**.
- 3 Go to a screen you want to capture.
- 4 Hold **HOME** for at least six seconds.

### Copying Screenshots to a Computer

- 1 Remove the memory card from the chartplotter, and insert it into a card reader that is attached to a computer.
- 2 From Windows Explorer, open the Garmin\scrn folder on the memory card.
- 3 Copy the image file from the card and paste it to any location on the computer.

## Troubleshooting

### My device will not acquire GPS signals

If the device is not acquiring satellite signals, there could be a few causes. If the device has moved a large distance since the last time it has acquired satellites or has been turned off for longer than a few weeks or months, the device may not be able to acquire the satellites correctly.

- Ensure the device is using the latest software. If not, update the device software ([Software Updates, page 70](#)).
- Make sure the device has a clear view of the sky so the antenna can receive the GPS signal. If it is mounted inside of a cabin, it should be close to a window so it can receive the GPS signal.



## My device will not turn on or keeps turning off

Devices erratically turning off or not turning on could indicate an issue with the power supplied to the device. Check these items to attempt to troubleshoot the cause of the power issue.

- Make sure the power source is generating power.  
You can check this several ways. For example, you can check whether other devices powered by the source are functioning.
- Check the fuse in the power cable.  
The fuse should be located in a holder that is part of the red wire of the power cable. Check that the proper size fuse is installed. Refer to the label on the cable or the installation instructions for the exact fuse size needed. Check the fuse to make sure there is still a connection inside of the fuse. You can test the fuse using a multimeter. If the fuse is good, the multimeter reads 0 ohm.
- Check to make sure the device is receiving at least 12 Vdc.  
To check the voltage, measure the female power and ground sockets of the power cable for DC voltage. If the voltage is less than 12 Vdc, the device will not turn on.
- If the device is receiving enough power but does not turn on, contact Garmin product support.

## My device is not creating waypoints in the correct location

You can manually enter a waypoint location to transfer and share data from one device to the next. If you have manually entered a waypoint using coordinates, and the location of the point does not appear where the point should be, the map datum and position format of the device may not match the map datum and position format originally used to mark the waypoint.

Position format is the way in which the GPS receiver's position appears on the screen. This is commonly displayed as latitude/longitude in degrees and minutes, with options for degrees, minutes and second, degrees only, or one of several grid formats.

Map datum is a math model which depicts a part of the surface of the earth. Latitude and longitude lines on a paper map are referenced to a specific map datum.

- 1 Find out which map datum and position format was used when the original waypoint was created.  
If the original waypoint was taken from a map, there should be a legend on the map that lists the map datum and position format used to create that map. Most often this is found near the map key.
- 2 Select  > **Preferences** > **Units**.
- 3 Select the correct map datum and position format settings.
- 4 Create the waypoint again.

## Contacting Garmin Support

- Go to [support.garmin.com](http://support.garmin.com) for help and information, such as product manuals, frequently asked questions, videos, and customer support.
- In the USA, call 913-397-8200 or 1-800-800-1020.
- In the UK, call 0808 238 0000.
- In Europe, call +44 (0) 870 850 1241.

# Specifications

## Specifications

### All Models

Material	Polycarbonate plastic
Water rating	IEC 60529 IPX7 <sup>3</sup>
Temperature range	From -15° to 55°C (from 5° to 131°F)
Input voltage	From 9 to 18 Vdc
Fuse	3 A, fast-acting (included)
Memory card	1 microSD card slot; 32 GB max. card size
Display resolution (W x H)	800 x 480 pixels
Display type	WVGA
Sonar frequencies <sup>4</sup>	Traditional: 50/200, 77/200, 83/200 kHz Single Channel CHIRP: from 40 to 250 kHz Garmin ClearVü CHIRP: 260/455/800 kHz
Sonar transmit power (RMS) <sup>5</sup>	CHIRP: 500 W Garmin ClearVü CHIRP: 500 W
Sonar depth <sup>6</sup>	701 m (2,300 ft.) at 77 kHz

### 5x Models

Dimensions, chartplotter only (W x H x D)	188 x 122 x 61.5 mm ( $7\frac{3}{8}$ x $4\frac{13}{16}$ x $2\frac{7}{16}$ in.)
Dimensions, in bail mount with sun cover (W x H x D)	212 x 143.3 x 100 mm ( $8\frac{3}{8}$ x $5\frac{5}{8}$ x $3\frac{15}{16}$ in.)
Display size (W x H)	109 x 65.8 mm ( $4\frac{5}{16}$ x $2\frac{9}{16}$ in.) 127.3 mm (5 in.) diagonal
Clearance to nearest obstruction behind chartplotter	57 mm ( $2\frac{1}{4}$ in.)
Weight	0.5 kg (1.1 lb.)
Max. power draw	8.4 W
Typical current draw at 12 Vdc (RMS)	600 mA
Max. current draw at 12 Vdc (RMS)	700 mA
Wireless frequency	2.4 GHz @ 19.7 dBm maximum
Compass-safe distance	7.62 cm (3 in.)

<sup>3</sup> The device withstands incidental exposure to water of up to 1 m for up to 30 min. For more information, go to [www.garmin.com/waterrating](http://www.garmin.com/waterrating).

<sup>4</sup> Dependent upon the transducer.

<sup>5</sup> Dependent upon the transducer rating and depth.

<sup>6</sup> Dependent upon the transducer, water salinity, bottom type, and other water conditions.

## 7x Models

Dimensions, device only (W x H x D)	232 x 143.1 x 67 mm ( $9\frac{1}{8}$ x $5\frac{5}{8}$ x $2\frac{5}{8}$ in.)
Dimensions, in bail mount with sun cover (W x H x D)	243.4 x 153.9 x 105.5 mm ( $9\frac{9}{16}$ x $6\frac{1}{16}$ x $4\frac{1}{8}$ in.)
Display size (W x H)	86.9 x 155.1 mm ( $3\frac{7}{16}$ x $6\frac{1}{8}$ in.) 177.8 mm (7 in.) diagonal
Clearance to nearest obstruction behind chartplotter	62.5 mm ( $2\frac{7}{16}$ in.)
Weight	0.68 kg (1.5 lb.)
Max. power draw	15 W
Typical current draw at 12 Vdc (RMS)	1.1 A
Max. current draw at 12 Vdc (RMS)	1.25 A
Wireless frequency	2.4 GHz @ 19.7 dBm maximum
Compass-safe distance	12.7 cm (5 in.)

