

# Quick®

CE REV 003A

## High Quality Nautical Equipment

# RRC

## RADIO REMOTE CONTROL THRUSTER POCKET TRANSMITTER

**PW4**

**PT4**

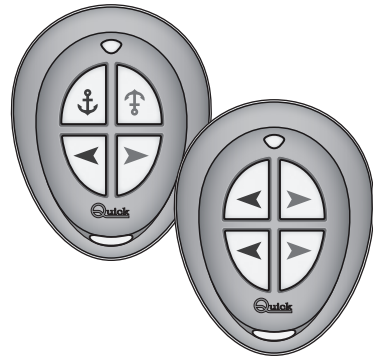

- IT** Manuale di installazione ed uso
- EN** Manual of installation and use
- FR** Mode d'installation et d'emploi
- DE** Installations- und Benutzerhandbuch
- ES** Manual de instalación y uso
- PT** Manual de Instalação e uso
- SE** Bruks och installationsanvisning
- NL** Gebruikers en installatie handleiding

**TRASMETTITORE TASCABILE RRC THRUSTER**  
**RRC THRUSTER POCKET TRANSMITTER**  
**ÉMETTEUR DE POCHE RRC THRUSTER**  
**TASCHENFUNKSENDER RRC THRUSTER**  
**TRANSMISOR DE BOLSILLO RRC THRUSTER**  
**TRANSMISSOR DE BOLSO RRC THRUSTER**  
**FICKSÄNDARE RRC THRUSTER**  
**POCKETZENDERS RRC THRUSTER**





---

<b>IT</b>	<b>INDICE</b>	Pag.	4	CARATTERISTICHE E FUNZIONAMENTO
		Pag.	5/6	FUNZIONAMENTO - corrispondenza tasto premuto e rele' attivato
		Pag.	7	FUNZIONAMENTO - sostituzione delle batterie
				MANUTENZIONE - DATI TECNICI

---

<b>EN</b>	<b>INDEX</b>	Pg.	8	CHARACTERISTICS AND OPERATION
		Pg.	9/10	OPERATION - correspondence between pressed key and activated relay
		Pg.	11	OPERATION - battery replacement
				MAINTENANCE - TECHNICAL DATA

---

<b>FR</b>	<b>SOMMAIRE</b>	P.	12	CARACTÉRISTIQUES ET FONCTIONNEMENT
		P.	13/14	FONCTIONNEMENT - correspondance touche appuyee e relais active
		P.	15	FONCTIONNEMENT - remplacement de la batterie
				ENTRETIEN - CARACTÉRISTIQUES TECHNIQUES

---

<b>DE</b>	<b>INHALTSANGABE</b>	S.	16	EIGENSCHAFTEN UND BETRIEB
		S.	17/18	BETRIEB - übereinstimmung von Gedrückter Taste und aktiviertem Relais
		S.	19	BETRIEB - Batteriewechsel
				WARTUNG - TECHNISCHE DATEN

---

<b>ES</b>	<b>INDICE</b>	Pág.	20	CARACTERÍSTICAS Y FUNCIONAMIENTO
		Pág.	21/22	FUNCIONAMIENTO - correspondencia botón presionado y relé activado
		Pág.	23	FUNCIONAMIENTO - sustitución de la batería
				MANTENIMIENTO - ESPECIFICACIONES TÉCNICAS

---

<b>PT</b>	<b>ÍNDICE</b>	Pág.	24	CARACTERÍSTICAS E FUNCIONAMENTO
		Pág.	25/26	FUNCIONAMENTO - correspondência tecla pressionada e relé ativado
		Pág.	27	FUNCIONAMENTO - substituição da pilha
				MANUTENÇÃO - DADOS TÉCNICOS

---

<b>SE</b>	<b>INNEHÅLLSFÖRTECKNING</b>	Sid.	28	EGENSKAPER OCH FUNKTION
		Sid.	29/30	FUNKTION - motsvarighet intryckt knapp och aktiverat relä
		Sid.	31	FUNKTION - batteribyte
				UNDERHÅLLSARBETE - TEKNISKA EGENSKAPER

---

<b>NL</b>	<b>INDEX</b>	S.	32	KENMERKEN EN WERKING
		S.	33/34	WERKING - overeenkomst ingedrukte toets en geactiveerd relais
		S.	35	WERKING - vervanging van de batterij
				ONDERHOUD - TECHNISCHE KENMERKEN

---



### TRASMETTITORE RADIO TASCABILE RRC THRUSTER

Il trasmettitore tascabile RRC Thruster è un dispositivo, abbinato ad un ricevitore radio RRC, atto a comandare i propulsori di manovra Quick® su imbarcazioni da diporto.

Il sistema radio RRC per propulsori di manovra deve essere utilizzato, come ausilio, ad un sistema cablato di comando per propulsore di manovra Quick già installato sull'imbarcazione.

 Adottare opportuni accorgimenti per evitare che il mancato funzionamento del sistema di comando radio RRC Thruster possa provocare danni a persone, animali o cose.

I vantaggi che il trasmettitore radio tascabile RRC Thruster offre sono:

- Funzionamento gestito da microcontrollore.
- Funzionamento in un ampio intervallo di temperature ambiente (da -15°C a +70°C).
- Modulazione FSK e frequenza portante 434.420Mhz.
- Indicazione tramite LED dello stato di funzionamento, batteria scarica e feedback di trasmissione.
- Galleggiante.

### INSTALLAZIONE

 **PRIMA DI UTILIZZARE IL TRASMETTITORE RADIO, LEGGERE ATTENTAMENTE IL PRESENTE MANUALE D'USO. IN CASO DI DUBBI CONTATTARE IL RIVENDITORE O IL SERVIZIO CLIENTI QUICK®.**

 In caso di discordanze o eventuali errori tra il testo tradotto e quello originario in italiano, fare riferimento al testo italiano o inglese.

 Questo dispositivo è stato progettato e realizzato per essere utilizzato su imbarcazioni da diporto. Non è consentito un utilizzo differente senza autorizzazione scritta da parte della società Quick®.

Il trasmettitore radio tascabile RRC Thruster è stato progettato e realizzato per gli scopi descritti in questo manuale d'uso. La società Quick® non si assume alcuna responsabilità per danni diretti o indiretti causati da un uso improprio del comando radio, da una errata installazione o da possibili errori presenti in questo manuale.

**LA CONFEZIONE CONTIENE:** trasmettitore radio tascabile con batteria installata - lanyard - condizioni di garanzia - il presente manuale di installazione ed uso.

### Trasmettitore tascabile

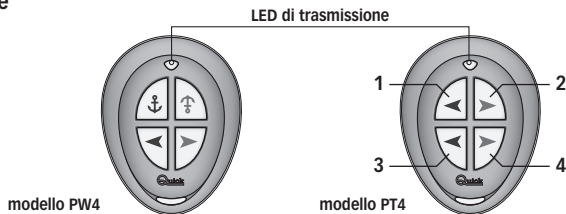





 **ATTENZIONE:** il trasmettitore va programmato nella memoria del ricevitore. Seguire la procedura indicata nel manuale d'uso del ricevitore.

### Alimentazione

Il trasmettitore tascabile è alimentato tramite una batteria CR2450 al litio. Per la sostituzione vedere il paragrafo SOSTITUZIONE DELLA BATTERIA.

### Abilitazione

il trasmettitore tascabile RRC Thruster si abilita mantenendo premuti entrambi i tasti   per il modello PW4 e **1**  **2**  per il modello PT4.

Alla loro pressione inizia a lampeggiare il led di trasmissione, di colore arancio, con cadenza regolare per poi passare ad un lampeggio veloce. Rilasciandoli il led di trasmissione mostrerà con un lampeggio breve lo stato di avvenuta abilitazione.

### Stato di funzionamento

Alla pressione di un qualsiasi tasto del trasmettitore il LED di trasmissione, di colore verde, lampeggia velocemente a segnalare l'avvenuta trasmissione. Ad ogni tasto premuto corrisponderà l'attivazione di un relè (o 2 relè) sul ricevitore che rimarrà attivo fino al rilascio del tasto.





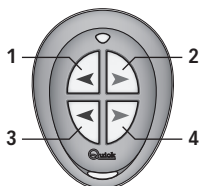
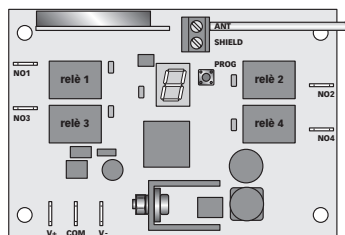



## CORRISPONDENZA TASTO PREMUTO E RELE' ATTIVATO

TRASMETTITORE TASCABILE  
RRC PW4 THRUSTERTRASMETTITORE TASCABILE  
RRC PT4 THRUSTER





RICEVITORE RADIO RRC R04





**Trasmettitore tascabile RRC PW4 Thruster e ricevitore radio RRC R04**

La pressione del tasto  (salita ancora) porta all'attivazione del relè 1 sul ricevitore.  
La pressione del tasto  (discesa ancora) porta all'attivazione del relè 2 sul ricevitore.  
La pressione contemporanea dei due tasti porta all'annullamento della trasmissione.

La pressione del tasto  (sinistra prua) porta all'attivazione del relè 3 sul ricevitore.  
La pressione del tasto  (destra prua) porta all'attivazione del relè 4 sul ricevitore.  
E' introdotto un ritardo di 2 secondi sulla trasmissione quando si passa dal tasto  (sinistra prua) al tasto  (destra prua) e viceversa.  
La pressione contemporanea dei due tasti porta all'annullamento della trasmissione.

**Trasmettitore tascabile RRC PT4 Thruster e ricevitore radio RRC R04**

La pressione del tasto **1**  (sinistra prua) porta all'attivazione del relè 1 sul ricevitore.  
La pressione del tasto **2**  (destra prua) porta all'attivazione del relè 2 sul ricevitore.  
E' introdotto un ritardo di 2 secondi sulla trasmissione quando si passa dal tasto **1**  (sinistra prua) al tasto **2**  (destra prua) e viceversa.  
La pressione contemporanea dei due tasti porta all'annullamento della trasmissione.

La pressione del tasto **3**  (sinistra poppa) porta all'attivazione del relè 3 sul ricevitore.  
La pressione del tasto **4**  (destra poppa) porta all'attivazione del relè 4 sul ricevitore.  
E' introdotto un ritardo di 2 secondi sulla trasmissione quando si passa dal tasto **3**  (sinistra poppa) al tasto **4**  (destra poppa) e viceversa.  
La pressione contemporanea dei due tasti porta all'annullamento della trasmissione.



## CORRISPONDENZA TASTO PREMUTO E RELE' ATTIVATO



TRASMETTITORE TASCABILE  
RRC PW4 THRUSTER

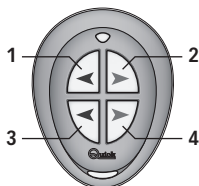

TRASMETTITORE TASCABILE  
RRC PT4 THRUSTER

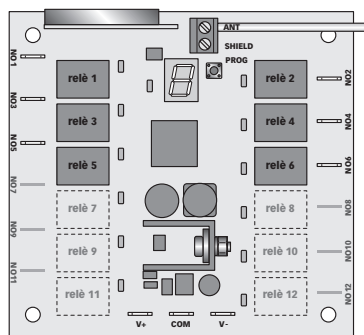

RICEVITORE RADIO RRC R06

### Trasmettitore tascabile RRC Thruster PW4 e ricevitore radio RRC R06

La pressione del tasto (salita ancora) porta all'attivazione del relè 1 sul ricevitore.  
La pressione del tasto (discesa ancora) porta all'attivazione del relè 2 sul ricevitore.  
La pressione contemporanea dei due tasti porta all'annullamento della trasmissione.

La pressione del tasto (sinistra prua) porta all'attivazione del relè 3 sul ricevitore.  
La pressione del tasto (destra prua) porta all'attivazione del relè 4 sul ricevitore.  
E' introdotto un ritardo di 2 secondi sulla trasmissione quando si passa dal tasto (sinistra prua) al tasto (destra prua) e viceversa.  
La pressione contemporanea dei due tasti porta all'annullamento della trasmissione.

### Trasmettitore tascabile RRC Thruster PT4 e ricevitore radio RRC R06

La pressione del tasto **1** (sinistra prua) porta all'attivazione del relè 3 sul ricevitore.  
La pressione del tasto **2** (destra prua) porta all'attivazione del relè 4 sul ricevitore.  
La pressione contemporanea dei due tasti porta all'annullamento della trasmissione.  
E' introdotto un ritardo di 2 secondi sulla trasmissione quando si passa dal tasto **1** (sinistra prua) al tasto **2** (destra prua) e viceversa.





La pressione del tasto **3** (sinistra poppa) porta all'attivazione del relè 5 sul ricevitore.  
La pressione del tasto **4** (destra poppa) porta all'attivazione del relè 6 sul ricevitore.  
E' introdotto un ritardo di 2 secondi sulla trasmissione quando si passa dal tasto **3** (sinistra poppa) al tasto **4** (destra poppa) e viceversa.  
La pressione contemporanea dei due tasti porta all'annullamento della trasmissione.



## Disabilitazione del trasmettitore

La disabilitazione del trasmettitore, che si trova nello stato di funzionamento, può avvenire in modo automatico e in modo manuale.



Modo automatico: se entro 3 minuti non sono premuti tasti il trasmettitore si disabilita e il LED di trasmissione si spegne.

Modo manuale: il trasmettitore può essere disabilitato anche manualmente senza attendere i 3 minuti. Mantenere premuti entrambi i tasti   per il modello PW4 e   per il modello PT4. Il LED di trasmissione, di colore arancione, mostrerà un lampeggio regolare per poi spegnersi a segnalare l'avvenuta disabilitazione del trasmettitore.

## Segnalazione batteria scarica

Si consiglia la sostituzione della batteria in tempi brevi se durante lo stato di funzionamento il colore del LED di trasmissione è rosso. Il tempo di autonomia residua dipende dalla qualità della batteria usata.

## SOSTITUZIONE DELLA BATTERIA

-  **ATTENZIONE:** pericolo di esplosione se la batteria è sostituita con altra di tipo non corretto.
-  **ATTENZIONE:** prima di operare sul trasmettitore assicurarsi che il ricevitore radio RRC non sia alimentato. Una pressione involontaria di un tasto potrebbe azionare il corrispondente utilizzatore creando situazioni di pericolo.

- Rimuovere la base del trasmettitore svitando le quattro viti con un cacciavite a stella.
- Rimuovere la batteria dal porta batteria facendola scorrere verso l'esterno evitando di servirsi di utensili metallici.
- Inserire la nuova batteria (del tipo indicato nelle caratteristiche tecniche) ponendo attenzione alla polarità del polo positivo (+) come indicato sul portapila metallico.
- Richiudere la base del trasmettitore controllando il suo corretto appoggio nella scanalatura della guarnizione sul frontale del trasmettitore in modo da ripristinare la tenuta.
- Riavvitare le quattro viti.

-  **ATTENZIONE:** verificare, una volta richiuso, il corretto funzionamento del trasmettitore.

-  Al termine del suo ciclo di vita, la batteria contenuta nel prodotto deve essere smaltita separatamente da altri rifiuti urbani non differenziati. Smaltire la batteria in conformità con le disposizioni di legge locali.

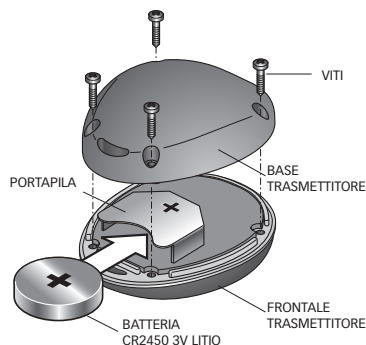

## MANUTENZIONE

Il trasmettitore radio tascabile RRC Thruster non richiede una particolare manutenzione. Per la sua pulizia utilizzare un panno morbido inumidito d'acqua. Non utilizzare prodotti chimici o abrasivi.

## CARATTERISTICHE TECNICHE

MODELLI	PW4	PT4
<b>CARATTERISTICHE DI INGRESSO</b>		
Alimentazione	Batteria CR2450 3V litio	
Assorbimento in trasmissione	13 mA	
<b>CARATTERISTICHE DEL TRASMETTITORE</b>		
Numero tasti	4	4
Frequenza portante	434.420 Mhz	
Modulazione	FSK	
Conforme alla direttiva	2014/53/EU (RED)	
<b>CARATTERISTICHE GENERALI</b>		
Temperatura operativa	da -15°C a +70°C	
Dimensioni (L x A x P)	60 x 47 x 23 mm	
Peso (comprensivo di batteria)	34 g	

QUICK\* SI RISERVA IL DIRITTO DI APPORTARE MODIFICHE ALLE CARATTERISTICHE TECNICHE DELL'APPARECCHIO E AL CONTENUTO DI QUESTO MANUALE SENZA ALCUN PREAVVISO.



### RRC THRUSTER POCKET RADIO TRANSMITTER

The RRC Thruster pocket transmitter is a device which combined with a RRC radio receiver is used to control Quick thrusters installed on recreational crafts.

The RRC radio system for thrusters must be used as a supplement to the Quick wired thruster control system already installed on the boat.

Take necessary steps in order to avoid that malfunctioning of the RRC Thruster radio control system may cause damage to people, animals or property.

The advantages offered by the RRC Thruster pocket radio transmitter are:

- Microcontroller-operated functions.
- Operating temperatures from -15°C to +70°C.
- FSK modulation and carrier frequency 434.420 Mhz.
- LED indication of operational status, low battery and transmission feedback.
- Floating.

### INSTALLATION

**BEFORE USING THE RADIO TRANSMITTER, CAREFULLY READ THIS USER MANUAL. IN CASE OF DOUBTS PLEASE CONTACT THE RETAILER OR QUICK® CUSTOMER SERVICE.**

In case of discordance or errors in translation between the translated version and the original text in the Italian language, reference will be made to the Italian or English text.

This device was designed and constructed for use on recreational crafts. Other forms of use are not permitted without written authorization from the company Quick®.

The RRC Thruster pocket radio transmitter has been designed and manufactured for the purposes described in this user manual. Quick® is not liable for direct or indirect damages caused by an improper use of the radio control, due to an incorrect installation or errors possibly present in this manual.

**THE PACKAGE CONTAINS:** pocket radio transmitter with battery included - lanyard - conditions of warranty - the present manual of installation and use.

### Pocket transmitter

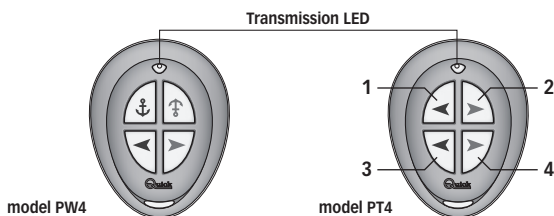

**WARNING:** the transmitter needs to be programmed in the receiver's memory. To do this, follow the procedure shown in the receiver's user manual.

### Power supply

The pocket transmitter is powered using a lithium CR2450 battery. To replace it, see the BATTERY REPLACEMENT paragraph.

### Enabling

The RRC Thruster pocket transmitter is enabled by keeping both keys pressed for the PW4 model and **1** **2** keys pressed for the PT4 model.

Once they have been pressed, the orange transmission LED first starts flashing at regular intervals and then starts flashing more quickly. After they have been released, the transmission LED will communicate through brief flashes that enabling has taken place.

### Operational status

When any of the transmitter keys is pressed, the green transmission LED flashes quickly to signal that transmission has taken place. Each key pressed corresponds to the activation of a relay (or 2 relays) on the receiver, which will stay active as long as the key isn't released.





## CORRESPONDENCE BETWEEN PRESSED KEY AND ACTIVATED RELAY



**POCKET TRANSMITTER  
RRC PW4 THRUSTER**

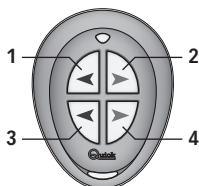



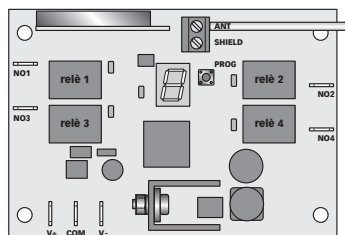



**POCKET TRANSMITTER  
RRC PT4 THRUSTER**







**RRC R04 RADIO RECEIVER**





### RRC PW4 Thruster pocket transmitter and RRC R04 radio receiver

Pressing the  key (anchor ascent) activates relay 1 on the receiver.  
Pressing the  key (anchor descent) activates relay 2 on the receiver.  
Pressing the two keys simultaneously cancels the transmission.

Pressing the  key (bow left) activates relay 3 on the receiver.  
Pressing the  key (bow right) activates relay 4 on the receiver.  
A 2 second transmission delay is introduced when passing from the  key (bow left) to the  key (bow right) and vice versa.  
Pressing the two keys simultaneously cancels the transmission.

### RRC PT4 Thruster pocket transmitter and RRC R04 radio receiver

Pressing the **1**  key (bow left) activates relay 1 on the receiver.  
Pressing the **2**  key (bow right) activates relay 2 on the receiver.  
A 2 second transmission delay is introduced when passing from the **1**  key (bow left) to the **2**  key (bow right) and vice versa.  
Pressing the two keys simultaneously cancels the transmission.

Pressing the **3**  key (stern left) activates relay 3 on the receiver.  
Pressing the **4**  key (stern right) activates relay 4 on the receiver.  
A 2 second transmission delay is introduced when passing from the **3**  key (stern left) to the **4**  key (stern right) and vice versa.  
Pressing the two keys simultaneously cancels the transmission.



### CORRESPONDENCE BETWEEN PRESSED KEY AND ACTIVATED RELAY



POCKET TRANSMITTER  
RRC PW4 THRUSTER

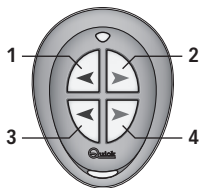



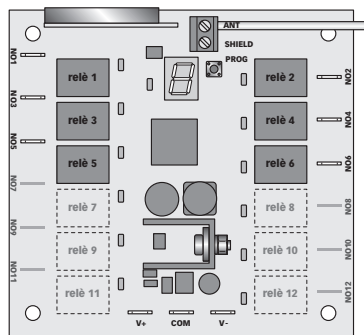



POCKET TRANSMITTER  
RRC PT4 THRUSTER







RRC R06 RADIO RECEIVER





#### RRC PW4 Thruster pocket transmitter and RRC R06 radio receiver

Pressing the  key (anchor ascent) activates relay 1 on the receiver.  
Pressing the  key (anchor descent) activates relay 2 on the receiver.  
Pressing the two keys simultaneously cancels the transmission.

Pressing the  key (bow left) activates relay 3 on the receiver.  
Pressing the  key (bow right) activates relay 4 on the receiver.  
A 2 second transmission delay is introduced when passing from the  key (bow left) to the  key (bow right) and vice versa.  
Pressing the two keys simultaneously cancels the transmission.

#### RRC PT4 Thruster pocket transmitter and RRC R06 radio receiver

Pressing the **1**  key (bow left) activates relay 3 on the receiver.  
Pressing the **2**  key (bow right) activates relay 4 on the receiver.  
Pressing the two keys simultaneously cancels the transmission.  
A 2 second transmission delay is introduced when passing from the **1**  key (bow left) to the **2**  key (bow right) and vice versa.

Pressing the **3**  key (stern left) activates relay 5 on the receiver.  
Pressing the **4**  key (stern right) activates relay 6 on the receiver.  
A 2 second transmission delay is introduced when passing from the **3**  key (stern left) to the **4**  key (stern right) and vice versa.





Pressing the two keys simultaneously cancels the transmission.



## Disabling the transmitter

The disabling of a transmitter that is in operational status can take place automatically and manually.

Automatic mode: if within 3 minutes no key has been pressed, the transmitter is disabled and the transmission LED shuts off.

Manual mode: the transmitter can also be disabled manually, without waiting 3 minutes. Keep both   keys pressed for the PW4 model and **1**  **2**  keys for the PT4 model. The orange transmission LED will flash regularly and then shut off to signal that the transmitter has been disabled.

## Low battery signal

It is recommended to replace the battery within a short period of time if the transmission LED is red during operation. The residual autonomy time depends on the quality of the battery used.

## BATTERY REPLACEMENT

 **WARNING:** danger of explosion if battery is replaced with an other of incorrect type.

 **WARNING:** before operating on the transmitter, make sure that the RRC radio receiver is not powered. Accidentally pressing a key may activate the corresponding device and create a dangerous situation.

- Remove the transmitter base by unscrewing the four screws using a Phillips screwdriver.
- Remove the battery from the battery holder sliding it outwards without using metal tools.
- Insert the new battery (of the type indicate in the technical characteristics) paying attention to polarity of the positive pole (+) as shown on the metal battery holder.
- Close the transmitter base, checking that it sits correctly in the gasket groove, located on the front of the transmitter, in order to restore the seal.
- Tighten the four screws.

 **WARNING:** once closed, verify that the transmitter is operating correctly.

 At the end of its useful life, the battery contained in the product must be disposed of separately from other separated urban waste. Dispose of the battery in accordance with the provisions of local law.

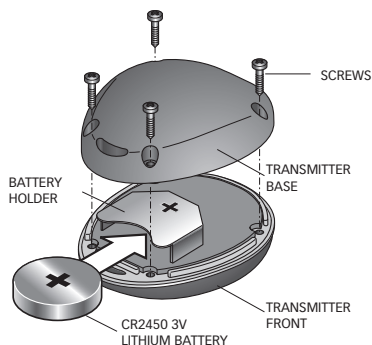

## MAINTENANCE

The RRC Thruster pocket radio transmitter does not require particular maintenance. Use a soft cloth moistened with water when cleaning it. Do not use chemical or abrasive products.

## TECHNICAL DATA

MODELS	PW4	PT4
<b>INPUT CHARACTERISTICS</b>		
Power supply	CR2450 3V lithium battery	
Absorption during transmission	13 mA	
<b>CHARACTERISTICS OF THE TRANSMITTER</b>		
Number of keys	4	4
Carrier frequency	434.420 Mhz	
Modulation	FSK	
Compliant with directive	2014/53/EU (RED)	
<b>GENERAL</b>		
Operating temperature	from -15°C to +70°C	
Dimensions (W x H x D)	60 x 47 x 23 mm	
Weight (including the battery)	34 g	

QUICK® RESERVES THE RIGHT TO MODIFY THE TECHNICAL CHARACTERISTICS OF THE EQUIPMENT AND THE CONTENTS OF THIS MANUAL WITHOUT PRIOR NOTICE.



## ÉMETTEUR RADIO DE POCHE RRC THRUSTER

L'émetteur de poche RRC Thruster est un dispositif, associé à un récepteur radio RRC, apte à commander le fonctionnement des propulseurs d'étrave Quick sur les bateaux de plaisance.

Le système radio RRC pour les propulseurs d'étrave doit être utilisé comme une aide à un système câblé de commande pour propulseur d'étrave Quick déjà installé sur le bateau.

 Adopter les précautions appropriées pour éviter que le mauvais fonctionnement du système de commande radio RRC Thruster puisse provoquer des dommages aux personnes, aux animaux et aux choses.

Les avantages offerts par l'émetteur radio de poche RRC Thruster sont:

- Fonctionnement géré par un microcontrôleur.
- Large gamme de températures de service ( de -15°C à +70°C).
- Modulation FSK et fréquence de l'onde porteuse 434.420Mhz.
- L'indication par une LED de l'état de fonctionnement, de la batterie déchargée et feedback de transmission.
- Flottant.

## INSTALLATION

 **AVANT D'UTILISER L'ÉMETTEUR RADIO, LIRE ATTENTIVEMENT LE PRESENT MODE D'EMPLOI. EN CAS DE DOUTES, CONTACTER LE REVENDEUR OU LE SERVICE CLIENTS QUICK®.**

 En cas de discordances ou d'erreurs éventuelles entre la traduction et le texte original en italien, se référer au texte italien ou anglais.

 Ce dispositif a été conçu et réalisé pour être utilisé sur des bateaux de plaisance. Tout autre emploi est interdit sans autorisation écrite de la société Quick®.

L'émetteur de poche RRC Thruster a été conçu et réalisé pour les objectifs décrits dans ce mode d'emploi.

La société Quick® n'assume aucune responsabilité pour les dommages directs ou indirects provoqués par un usage impropre de la commande radio, une installation erronée ou par des erreurs éventuelles contenues dans ce mode d'emploi.

**L'EMBALLAGE CONTIENT:** émetteur radio de poche avec batterie installées - lanyard - conditions de garantie - le mode d'installation et d'emploi.

## Emetteur de poche

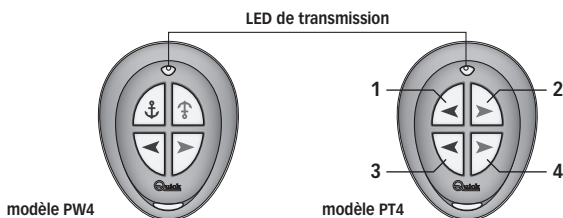





 **ATTENTION:** l'émetteur doit être programmé dans la mémoire du récepteur. Suivre la procédure indiquée dans le mode d'emploi du récepteur.

### Alimentation

L'émetteur de poche est alimenté par une batterie CR2450 au lithium. Pour la remplacer voir au paragraphe REMPLACEMENT DE LA BATTERIE.

### Activation

L'émetteur de poche RRC Thruster s'active en maintenant appuyées les deux touches   pour le modèle PW4 et **1**  **2**  pour le modèle PT4.

Dès leur pression, le led de transmission de couleur orange commence à clignoter, avec une cadence régulière pour passer ensuite à un clignotement rapide. En les relâchant, le led de transmission montrera avec un clignotement bref que d'activation est effectuée.

### Etat de fonctionnement

Durant la pression de n'importe quelle touche, la LED de transmission, de couleur verte, clignote rapidement pour signaler que la transmission a eu lieu. Chaque touche pressée correspondra à l'activation d'un relais (ou 2 relais) sur le récepteur qui sera actif jusqu'au relâchement de la touche même.



## CORRESPONDANCE TOUCHE APPUYEE E RELAIS ACTIVE



ÉMETTEUR DE POUCHE  
RRC PW4 THRUSTER

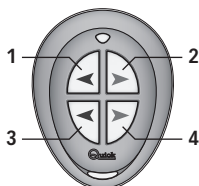

ÉMETTEUR DE POUCHE  
RRC PT4 THRUSTER

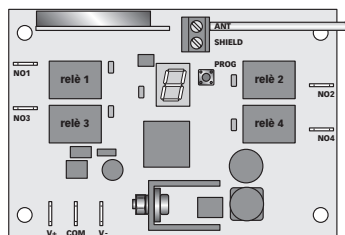

RÉCEPTEUR RADIO RRC R04

### Émetteur de poche RRC PW4 Thruster et Récepteur radio RRC R04

La pression de la touche (montée ancre) permet l'activation du relais 1 sur le récepteur.  
La pression de la touche (descente ancre) permet l'activation du relais 2 sur le récepteur.  
La pression simultanée des deux touches permet l'annulation de la transmission.

La pression de la touche (gauche proue) permet l'activation du relais 3 sur le récepteur.  
La pression de la touche (droite proue) permet l'activation du relais 4 sur le récepteur.  
Il y a un retard de 2 secondes sur la transmission quand on passe de la touche (gauche proue) à la touche (droite proue) et vice versa.  
La pression simultanée des deux touches permet l'annulation de la transmission.

### Émetteur de poche RRC PT4 Thruster et Récepteur radio RRC R04

La pression de la touche **1** (gauche poupe) permet l'activation du relais 1 sur le récepteur.  
La pression de la touche **2** (droite poupe) permet l'activation du relais 2 sur le récepteur.  
Il y a un retard de 2 secondes sur la transmission quand on passe de la touche **1** (gauche poupe) à la touche **2** (droite poupe) et vice versa.  
La pression simultanée des deux touches permet l'annulation de la transmission.

La pression de la touche **3** (gauche poupe) permet l'activation du relais 3 sur le récepteur.  
La pression de la touche **4** (droite poupe) permet l'activation du relais 4 sur le récepteur.  
Il y a un retard de 2 secondes sur la transmission quand on passe de la touche **3** (gauche poupe) à la touche **4** (droite poupe) et vice versa.  
La pression simultanée des deux touches permet l'annulation de la transmission.





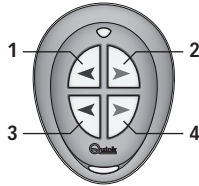
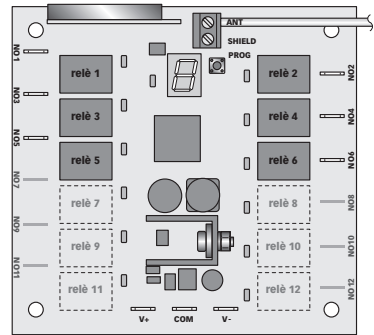



## CORRESPONDANCE TOUCHE APPUYÉE E RELAIS ACTIVE

ÉMETTEUR DE POCHE  
RRC PW4 THRUSTERÉMETTEUR DE POCHE  
RRC PT4 THRUSTER





RÉCEPTEUR RADIO RRC R06





## EMETTEUR DE POCHE RRC PW4 THRUSTER ET RÉCEPTEUR RADIO RRC R06

La pression de la touche  (montée ancre) permet l'activation du relais 1 sur le récepteur.  
 La pression de la touche  (descente ancre) permet l'activation du relais 2 sur le récepteur.  
 La pression simultanée des deux touches permet l'annulation de la transmission.

La pression de la touche  (gauche proue) permet l'activation du relais 3 sur le récepteur.  
 La pression de la touche  (droite proue) permet l'activation du relais 4 sur le récepteur.  
 Il y a un retard de 2 secondes sur la transmission quand on passe de la touche  (gauche proue) à la touche  (droite proue) et vice versa.  
 La pression simultanée des deux touches permet l'annulation de la transmission.

## EMETTEUR DE POCHE RRC PT4 THRUSTER ET RÉCEPTEUR RADIO RRC R06

La pression de la touche **1**  (gauche poupe) permet l'activation du relais 3 sur le récepteur.  
 La pression de la touche **2**  (droite poupe) permet l'activation du relais 4 sur le récepteur.  
 Il y a un retard de 2 secondes sur la transmission quand on passe de la touche **1**  (gauche poupe) à la touche **2**  (droite poupe) et vice versa.  
 La pression simultanée des deux touches permet l'annulation de la transmission.

La pression de la touche **3**  (gauche poupe) permet l'activation du relais 5 sur le récepteur.  
 La pression de la touche **4**  (droite poupe) permet l'activation du relais 6 sur le récepteur.  
 Il y a un retard de 2 secondes sur la transmission quand on passe de la touche **3**  (gauche poupe) à la touche **4**  (droite poupe) et vice versa.  
 La pression simultanée des deux touches permet l'annulation de la transmission.



## Désactivation de l'émetteur

La désactivation de l'émetteur, qui se trouve en état de marche, peut avoir lieu automatiquement ou manuellement.

Mode automatique: Si dans les 3 minutes les touches ne sont pas appuyées, l'émetteur se désactive et le LED de transmission s'éteint.

Mode Manuel: l'émetteur peut être désactivé même manuellement sans attendre 3 minutes. Maintenir appuyées les deux touches pour le modèle PW4 et pour le modèle PT4. Le LED de transmission de couleur orange clignotera de manière régulière et s'éteindra ensuite pour signaler la désactivation de l'émetteur.

## Signalisation de batterie déchargée

Si, au cours du fonctionnement, la couleur de la LED de transmission est rouge, il est conseillé de changer la batterie dans de brefs délais. Le délai d'autonomie dépend du type et de la qualité de la batterie utilisée.

## REPLACEMENT DE LA BATTERIE

- ATTENTION:** danger d'explosion si la batterie est remplacée par une batterie incorrect.
- ATTENTION:** avant d'opérer sur l'émetteur, s'assurer que le récepteur radio RRC n'est pas alimenté. La pression involontaire d'une touche pourrait actionner l'utilisateur correspondant et créer des situations dangereuses.

- Enlever la base de l'émetteur en dévissant les quatre vis à l'aide d'un tournevis étoile.
- Enlever la batterie du porte batterie en la faisant glisser vers l'extérieur et en évitant de se servir d'outils métalliques.
- Introduire la nouvelle batterie (du type indiqué dans les caractéristiques techniques) en faisant attention à la polarité du pôle positif (+) de la façon indiquée sur le porte-batterie métallique.
- Refermer en contrôlant que la base de l'émetteur soit correctement placée dans la rainure de la garniture située sur la partie antérieure de l'émetteur de façon à rétablir l'étanchéité.
- Revisser les quatre vis.

- ATTENTION:** une fois qu'il est refermé, vérifier que l'émetteur fonctionne correctement

A la fin de cycle de vie, la batterie contenue dans le produit doit être éliminés séparément des autres déchets et être éliminés dans le spécial récipient. Jeter la batterie conformément à la législation locale.

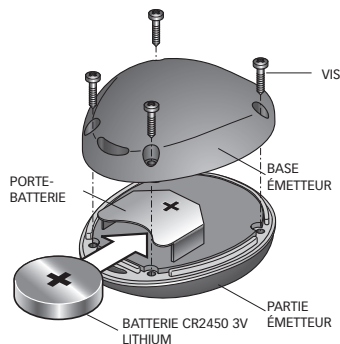

## ENTRETIEN

L'émetteur radio de poche RRC Thruster n'a pas besoin d'une maintenance particulière. Pour le nettoyer utiliser un chiffon souple humide. Ne pas utiliser de produits chimiques ou abrasifs.

## CARACTÉRISTIQUES TECHNIQUES

MODÈLES	PW4	PT4
<b>CARACTÉRISTIQUES D'ENTREE</b>		
Alimentation	Batterie CR2450 3V lithium	
Consommation en transmission	13 mA	
<b>CARACTÉRISTIQUES DE L'ÉMETTEUR</b>		
Nombre de touches	4	4
Fréquence sur onde porteuse	434.420 Mhz	
Modulation	FSK	
Conformément à la norme	2014/53/EU (RED)	
<b>CARACTÉRISTIQUES GÉNÉRALES</b>		
Température de service	de -15°C à +70°C	
Dimensions (L x H x P)	60 x 47 x 23 mm	
Poids (batterie incluse)	34 g	

QUICK® SE RÉSERVE LE DROIT D'APPORTER DES MODIFICATIONS AUX CARACTÉRISTIQUES TECHNIQUES DE L'INSTRUMENT ET AU CONTENU DE CE MODE D'EMPLOI SANS AUCUN PRÉAVIS.



### TASCHENFUNKSENDER RRC THRUSTER

Der Taschenfunktaster RRC Thruster ist eine Vorrichtung - Funkempfänger RRC kombiniertes Gerät zur Betriebssteuerung von in Sportbooten installierten Quick Bugschrauben und Zusatzeinrichtungen.

Das RRC-Funksystem für Bugschrauben muss zusätzlich zur verkabelten Steuerung der Bugschrauben von Quick verwendet werden, die bereits an Bord installiert ist.

Geeignete Maßnahmen ergreifen, um zu verhindern, dass der Ausfall des Funksteuersystems RRC Thruster zu Schäden an Personen, Tieren oder Dingen führen kann.

Die Vorzüge des Taschenfunktaster RRC Thruster sind:

- Der Betrieb wird über einen Microcontroller gesteuert.
- Betrieb innerhalb eines weiten Umgebungstemperaturbereichs ( von -15°C bis +70°C).
- FSK - Modulation und Trägerfrequenz 434.420Mhz.
- Anzeige des Betriebsstatus, der entladenen Batterie sowie der Übertragungsrückmeldung per LED.
- Schwimmendes Gerät.

### INSTALLATION

**LESEN SIE VOR DER VERWENDUNG DES FUNKSENDERS DIESES BEDIENUNGSHANDBUCH AUFMERKSAM. IM ZWEIFELSFALL DEN QUICK® VERTRAGSHÄNDLER KONSULTIEREN.**

Bei Fehlern oder eventuellen Unstimmigkeiten zwischen der Übersetzung und dem Ausgangstext ist der Ausgangstext in Italienisch oder Englisch maßgeblich.

Diese Vorrichtung wurde für den Einsatz auf Sportbooten entwickelt und realisiert. Ohne schriftliche Zustimmung durch Quick® ist keine anderweitige Nutzung zulässig.

Der Taschenfunktaster RRC Thruster wurde für die in diesem Handbuch beschriebenen Einsätze entwickelt und hergestellt. Die Quick® haftet nicht für direkte oder indirekte Schäden, die durch eine unsachgemäße Verwendung der Funksteuerung, eine fehlerhafte Installation oder mögliche Fehler im Handbuch verursacht werden.

**DIE PACKUNG ENTHÄLT:** Taschenfunktaster - Batterie - Lanyard - Garantiebedingungen - Installations- und Benutzerhandbuch.

### Taschenfunktaster

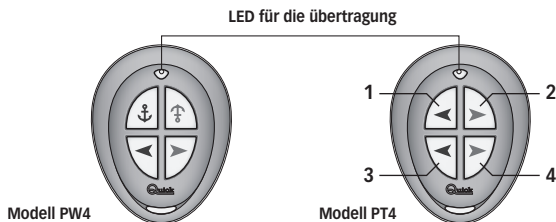

**ACHTUNG:** Das Sendegerät wird im Speicher des Empfangsgeräts programmiert. Befolgen Sie die Anweisungen des Handbuchs vom Empfangsgerät.

### Versorgung

Das Taschensendegerät wird mit einer CR2450 Lithiumbatterie gespeist. Zum Wechseln der Batterien siehe Absatz BATTERIEWECHSEL.

### Freigabe

Der Taschenfunktaster RRC Thruster wird beim Modell PW4 durch gleichzeitiges Gedrückthalten der Tasten und beim Modell PT4 der Tasten **1** **2** aktiviert.



Beim Drücken beginnt die orangefarbene Übertragungs-LED mit einer gleichmäßigen Frequenz zu blinken und blinkt dann schnell. Beim Loslassen blinkt die Übertragungs-LED kurz, um zu signalisieren, dass die Aktivierung stattgefunden hat.



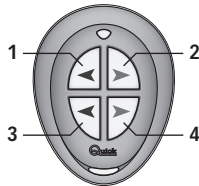
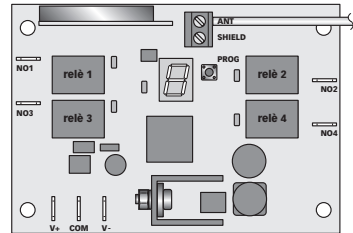

### Betriebszustand

Beim Drücken einer beliebigen Taste des Sendegeräts blinkt die grüne LED für die Übertragung schnell und zeigt so die erfolgte Übertragung an. Jede betätigte Taste entspricht der Aktivierung eines Relais (oder 2 Relais) am Empfangsgerät solange die Taste gedrückt ist, bleibt das Relais aktiviert.











**ÜBEREINSTIMMUNG VON GEDRÜCKTER TASTE UND AKTIVIERTEM RELAIS****TASCHENFUNKSENDER  
RRC PW4 THRUSTER****TASCHENFUNKSENDER  
RRC PT4 THRUSTER****FUNKEMPFÄNGER RRC R04****Taschenfunktensender RRC PW4 Thruster und Funkempfänger RRC R04**

Das Drücken der Taste  (Heben des Ankers) führt zur Aktivierung des Relais 1 am Empfänger.  
Das Drücken der Taste  (Senken des Ankers) führt zur Aktivierung des Relais 2 am Empfänger.  
Das gleichzeitige Drücken der Tasten führt zur Annullierung der Übertragung.

Das Drücken der Taste  (Bug links) führt zur Aktivierung des Relais 3 am Empfänger.  
Das Drücken der Taste  (Bug rechts) führt zur Aktivierung des Relais 4 am Empfänger.  
Es gibt eine Verzögerung der Übertragung von 2 Sekunden, wenn man von der Taste  (Bug links) zur Taste  (Bug rechts) wechselt, und umgekehrt.  
Das gleichzeitige Drücken der Tasten führt zur Annullierung der Übertragung.

**Taschenfunktensender RRC PT4 Thruster und Funkempfänger RRC R04**

Das Drücken der Taste **1**  (Bug links) führt zur Aktivierung des Relais 1 am Empfänger.  
Das Drücken der Taste **2**  (Bug rechts) führt zur Aktivierung des Relais 2 am Empfänger.  
Es gibt eine Verzögerung der Übertragung von 2 Sekunden, wenn man von der Taste **1**  (Bug links) zur Taste **2**  (Bug rechts) wechselt, und umgekehrt.  
Das gleichzeitige Drücken der Tasten führt zur Annullierung der Übertragung.

Das Drücken der Taste **3**  (Heck links) führt zur Aktivierung des Relais 3 am Empfänger.  
Das Drücken der Taste **4**  (Heck rechts) führt zur Aktivierung des Relais 4 am Empfänger.  
Es gibt eine Verzögerung der Übertragung von 2 Sekunden, wenn man von der Taste **3**  (Heck links) zur Taste **4**  (Heck rechts) wechselt, und umgekehrt.  
Das gleichzeitige Drücken der Tasten führt zur Annullierung der Übertragung.



**ÜBEREINSTIMMUNG VON GEDRÜCKTER TASTE UND AKTIVIERTEM RELAIS**



**TASCHENFUNKSENDER  
RRC PW4 THRUSTER**

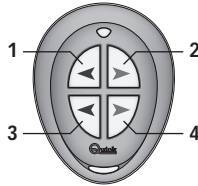

**TASCHENFUNKSENDER  
RRC PT4 THRUSTER**

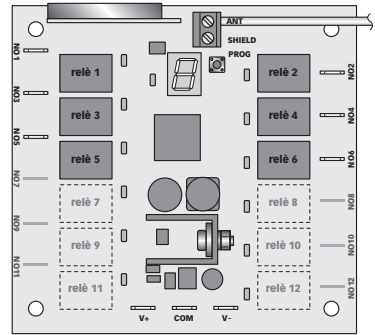

**FUNKEMPFÄNGER RRC R06**

**Taschenkunksender RRC PW4 Thruster und Funkempfänger RRC R06**

Das Drücken der Taste (Heben des Ankers) führt zur Aktivierung des Relais 1 am Empfänger.  
 Das Drücken der Taste (Senken des Ankers) führt zur Aktivierung des Relais 2 am Empfänger.  
 Das gleichzeitige Drücken der Tasten führt zur Annullierung der Übertragung.

Das Drücken der Taste (Bug links) führt zur Aktivierung des Relais 3 am Empfänger.  
 Das Drücken der Taste (Bug rechts) führt zur Aktivierung des Relais 4 am Empfänger.  
 Es gibt eine Verzögerung der Übertragung von 2 Sekunden, wenn man von der Taste (Bug links) zur Taste (Bug rechts) wechselt, und umgekehrt.  
 Das gleichzeitige Drücken der Tasten führt zur Annullierung der Übertragung.

**Taschenkunksender RRC PT4 Thruster und Funkempfänger RRC R06**

Das Drücken der Taste **1** (Bug links) führt zur Aktivierung des Relais 3 am Empfänger.  
 Das Drücken der Taste **2** (Bug rechts) führt zur Aktivierung des Relais 4 am Empfänger.  
 Das gleichzeitige Drücken der Tasten führt zur Annullierung der Übertragung.  
 Es gibt eine Verzögerung der Übertragung von 2 Sekunden, wenn man von der Taste **1** (Bug links) zur Taste **2** (Bug rechts) wechselt, und umgekehrt.

Das Drücken der Taste **3** (Heck links) führt zur Aktivierung des Relais 5 am Empfänger.  
 Das Drücken der Taste **4** (Heck rechts) führt zur Aktivierung des Relais 6 am Empfänger.  
 Es gibt eine Verzögerung der Übertragung von 2 Sekunden, wenn man von der Taste **3** (Heck links) zur Taste **4** (Heck rechts) wechselt, und umgekehrt.  
 Das gleichzeitige Drücken der Tasten führt zur Annullierung der Übertragung.



## Deaktivierung des Sendegeräts

Die Deaktivierung des sich in Betrieb befindlichen Sendegeräts kann automatisch oder manuell erfolgen.

Automatisch: Wenn die Tasten nicht innerhalb von 3 Minuten gedrückt werden, wird der Funksender deaktiviert und die Übertragungs-LED erlischt.

Manuell: Das Sendegerät kann vor Ablauf der 3 Minuten auch manuell deaktiviert werden. Beim Modell PW4 die Tasten   gedrückt halten und beim Modell PT4 die Tasten **1**  und **2** . Die orangefarbene Übertragungs-LED blinkt regelmäßig und erlischt beim Signal der stattgefundenen Deaktivierung des Funksenders.

## Anzeige für entladene Batterie

Es empfiehlt sich, die Batterie innerhalb kurzer Zeit auszuwechseln, wenn während des Betriebs die LED für die Übertragung rot leuchtet. Die verbliebene Autonomie ist von der Qualität der verwendeten Batterie abhängig.

## BATTERIEWECHSEL

 **ACHTUNG:** Explosionsgefahr wenn die Batterie durch eine andere, nicht dem ursprünglichen Type entsprechende Batterie ausgetauscht wird.

 **ACHTUNG:** Kontrollieren Sie vor den Arbeiten am Sendegerät, dass der RRC - Funkempfänger nicht gespeist wird. Eine unbeabsichtigtes Drücken einer Taste könnte den entsprechenden Verbraucher aktivieren und Gefahrensituationen erzeugen.

- Entfernen Sie das Sendegerät aus der Basis, indem Sie die vier Schrauben mit einem Kreuzschlitzschraubendreher lösen.
- Entnehmen Sie die Batterie aus ihrer Halterung, indem Sie diese nach außen schieben; vermeiden Sie den Gebrauch von Metallwerkzeugen.
- Legen Sie die neue Batterie (der in den technischen Eigenschaften beschriebenen Art) ein und achten Sie dabei darauf, dass die Polarität des Pluspols (+) der Angabe auf der Halterung aus Metall entspricht.
- Verschließen Sie das Sendegerät wieder und kontrollieren Sie, dass es korrekt in der Rille der Dichtung auf der Vorderseite des Sendegeräts sitzt, damit deren Dichtigkeit wiederhergestellt wird.
- Ziehen Sie die vier Schrauben wieder an.

 **ACHTUNG:** Prüfen Sie nach dem Verschluss die Funktionstüchtigkeit des Sendegeräts.

 Am Ende ihres Lebenszyklus muss die Batterie des Produkts getrennt vom normalen Hausmüll entsorgt werden. Die Batterie gemäß den lokalen Gesetzesvorschriften entsorgen.

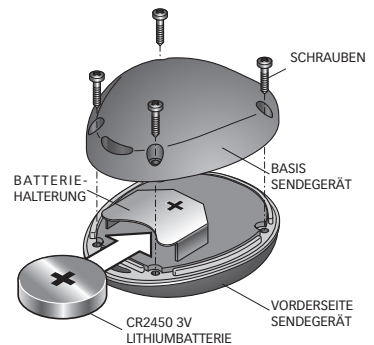

## WARTUNG

Der Taschenfunktensender RRC Thruster bedarf keiner besonderen Wartung. Reinigen Sie ihn mit einem weichen angefeuchteten Tuch. Verwenden Sie keine chemischen bzw. Scheuermittel.

## TECHNISCHE DATEN

MODELLE	PW4	PT4
<b>EINGANGSEIGENSCHAFTEN</b>		
Versorgung	CR2450 3V Lithiumbatterie	
Stromaufnahme bei Übertragung	13 mA	
<b>EIGENSCHAFTEN DES SENDEGERÄTS</b>		
Anzahl Tasten	4	4
Trägerfrequenz	434.420 Mhz	
Modulation	FSK	
Gemäß Verordnung	2014/53/EU (RED)	
<b>ALLGEMEINES</b>		
Betriebstemperatur	von -15°C bis +70°C	
Abmessungen (L x B x T)	60 x 47 x 23 mm	
Gewicht (mit Batterie)	34 g	

QUICK® BEHÄLT SICH DAS RECHT AUF ÄNDERUNGEN DER TECHNISCHEN EIGENSCHAFTEN DES GERÄTS UND DES INHALTS DIESES HANDBUCHS OHNE VORANKÜNDIGUNG VOR.



### TRANSMISOR DE RADIO DE BOLSILLO RRC THRUSTER

El transmisor de bolsillo RRC Thruster es un dispositivo, combinado a un receptor radio RRC, indicado para controlar el funcionamiento de los propulsores de maniobra Quick en embarcaciones de recreo.

El sistema de radio RRC para propulsores de maniobra debe ser utilizado, como auxilio, en un sistema cableado de comando para propulsor de maniobra Quick ya instalado en la embarcación.

Adopte las precauciones necesarias para evitar que la falta de funcionamiento del sistema de comando de radio RRC Thruster pueda provocar daños a las personas, animales o cosas.

Las ventajas que el transmisor radio de bolsillo RRC ofrece son:

- Funcionamiento gestionado por microcontrolador.
- Funcionamiento en un amplio intervalo de temperaturas ambiente (de -15 °C a +70 °C).
- Modulación FSK y frecuencia portante 434.420 MHz.
- Indicación mediante LED del estado de funcionamiento, batería descargada y feedback de transmisión.
- Flotante.

### INSTALACIÓN

**ANTES DE UTILIZAR EL TRANSMISOR RADIO, LEER ATENTAMENTE EL PRESENTE MANUAL DE USO. EN CASO DE DUDAS CONTACTAR EL REVENDEDOR O EL SERVICIO DE CLIENTES QUICK®.**

En caso de discordancias o eventuales errores entre el texto traducido y el texto original en italiano, remitirse al texto en italiano o en inglés.

Este dispositivo ha sido diseñado y realizado para ser utilizado en embarcaciones de recreo. No se permite ningún uso diferente sin autorización escrita por parte de la sociedad Quick®.

El transmisor de radio de bolsillo RRC Thruster ha sido diseñado y realizado para las finalidades descritas en este manual de uso. La sociedad Quick® no asume ninguna responsabilidad por daños directos o indirectos causados por un uso inapropiado del mando radio, por una instalación incorrecta o por posibles errores presentes en este manual.

**LA CONFECCIÓN CONTIENE:** transmisor radio de bolsillo con batería incluidas - lanyard - condiciones de garantía - manual de instalación y uso.

### Transmisor de bolsillo

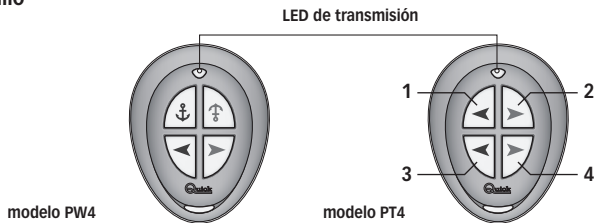

**ATENCIÓN:** el transmisor se programa en la memoria del receptor. Seguir el procedimiento indicado en el manual de uso del receptor.

### Alimentación

El transmisor de bolsillo se alimenta mediante una batería CR2450 de litio. Para la sustitución, ver el apartado SUSTITUCIÓN DE LA BATERÍA.

### Habilitación

El transmisor de bolsillo RRC Thruster se activa manteniendo presionadas ambas teclas para el modelo PW4 y para el modelo PT4.

Al presionarlos comenzará a parpadear el led de transmisión, de color naranja, con una frecuencia regular para pasar luego a un parpadeo rápido. Al soltarlos el led de transmisión mostrará con un parpadeo breve el estado de la activación.

### Estado de funcionamiento

Cuando se pulsa cualquier tecla del transmisor el LED de transmisión, de color verde, parpadea rápidamente para señalar la transmisión realizada. A cada tecla pulsada corresponde la activación de un relé (o 2 relés) en el receptor que quedará activo hasta que la tecla no será soltada.



## CORRESPONDENCIA BOTÓN PRESIONADO Y RELÉ ACTIVADO



**TRANSMISOR DE BOLSILLO  
RRC PW4 THRUSTER**

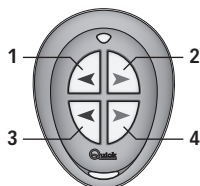

**TRANSMISOR DE BOLSILLO  
RRC PT4 THRUSTER**

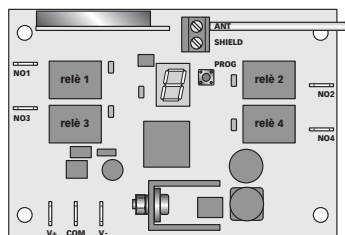

**RECEPTOR RADIO RRC R04**

### Transmisor de bolsillo RRC PW4 Thruster y receptor de radio RRC R04

Al presionar la tecla  (subida ancla) se activa el relé 1 del receptor.

Al presionar la tecla  (bajada ancla) se activa el relé 2 del receptor.

Al presionar las dos teclas al mismo tiempo se cancela la transmisión.

Al presionar la tecla  (izquierda proa) se activa el relé 3 del receptor.

Al presionar la tecla  (derecha proa) se activa el relé 4 del receptor.

Cuando se pasa de la tecla  (izquierda proa) a la tecla  (derecha proa) y viceversa, se produce una demora de 2 segundos en la transmisión.

Al presionar las dos teclas al mismo tiempo se cancela la transmisión.

### Transmisor de bolsillo RRC PT4 Thruster y receptor de radio RRC R04

Al presionar la tecla **1**  (izquierda proa) se activa el relé 1 del receptor.

Al presionar la tecla **2**  (derecha proa) se activa el relé 2 del receptor.

Cuando se pasa de la tecla **1**  (izquierda proa) a la tecla **2**  (derecha proa) y viceversa, se produce una demora de 2 segundos en la transmisión.

Al presionar las dos teclas al mismo tiempo se cancela la transmisión.

Al presionar la tecla **3**  (izquierda popa) se activa el relé 3 del receptor.

Al presionar la tecla **4**  (derecha popa) se activa el relé 4 del receptor.

Cuando se pasa de la tecla **3**  (izquierda popa) a la tecla **4**  (derecha popa) y viceversa, se produce una demora de 2 segundos en la transmisión.

Al presionar las dos teclas al mismo tiempo se cancela la transmisión.



**CORRESPONDENCIA BOTÓN PRESIONADO  
Y RELÉ ACTIVADO**



**TRANSMISOR DE BOLSILLO  
RRC PW4 THRUSTER**

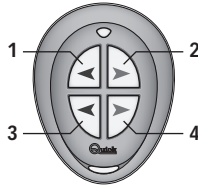

**TRANSMISOR DE BOLSILLO  
RRC PT4 THRUSTER**

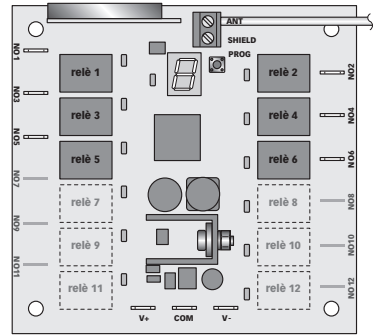

**RECEPTOR RADIO RRC R06**

**Transmisor de bolsillo RRC PW4 Thruster y receptor de radio RRC R06**

Al presionar la tecla ⚓ (subida ancla) se activa el relé 1 del receptor.  
 Al presionar la tecla ⚓ (bajada ancla) se activa el relé 2 del receptor.  
 Al presionar las dos teclas al mismo tiempo se cancela la transmisión.

Al presionar la tecla ◀ (izquierda proa) se activa el relé 3 del receptor.  
 Al presionar la tecla ▶ (derecha proa) se activa el relé 4 del receptor.  
 Cuando se pasa de la tecla ◀ (izquierda proa) a la tecla ▶ (derecha proa) y viceversa, se produce una demora de 2 segundos en la transmisión.  
 Al presionar las dos teclas al mismo tiempo se cancela la transmisión.

**Transmisor de bolsillo RRC PT4 Thruster y receptor de radio RRC R06**

Al presionar la tecla 1 ◀ (izquierda proa) se activa el relé 3 del receptor.  
 Al presionar la tecla 2 ▶ (derecha proa) se activa el relé 4 del receptor.  
 Al presionar las dos teclas al mismo tiempo se cancela la transmisión.  
 Cuando se pasa de la tecla 1 ◀ (izquierda proa) a la tecla 2 ▶ (derecha proa) y viceversa, se produce una demora de 2 segundos en la transmisión.





Al presionar la tecla 3 ◀ (izquierda popa) se activa el relé 5 del receptor.  
 Al presionar la tecla 4 ▶ (derecha popa) se activa el relé 6 del receptor.  
 Cuando se pasa de la tecla 3 ◀ (izquierda popa) a la tecla 4 ▶ (derecha popa) y viceversa, se produce una demora de 2 segundos en la transmisión.  
 Al presionar las dos teclas al mismo tiempo se cancela la transmisión.



## Deshabilitación del transmisor

La deshabilitación del transmisor que se encuentra en el estado de funcionamiento se puede realizar en modo automático y en modo manual.



Modo automático: si dentro de 3 minutos no se presionan las teclas, el transmisor se desactiva y el LED de transmisión se apaga.

Modo manual: el transmisor se puede deshabilitar también manualmente sin esperar los 3 minutos. Mantenga presionadas ambas teclas   para el modelo PW4 y   para el modelo PT4. El LED de transmisión, de color naranja, mostrará un parpadeo regular y luego se apagará indicando la desactivación del transmisor.

## Señalización batería descargada

Se aconseja la sustitución de la batería en tiempos breves si durante el estado de funcionamiento el color del LED de transmisión es rojo. El tiempo de autonomía residual depende de la calidad de la batería utilizada.

## SUSTITUCIÓN DE LA BATERÍA

-  **ATENCIÓN:** peligro de explosión si la batería se sustituye con otra de tipo no correcto.
-  **ATENCIÓN:** antes de operar en el transmisor asegurarse de que el receptor radio RRC no esté alimentado. Una presión involuntaria de una tecla puede accionar el correspondiente punto de utilización creando situaciones de peligro.

- Quitar la base del transmisor desenroscando los cuatro tornillos con un destornillador de estrella.
- Quitar la batería del porta batería deslizando hacia el externo y evitando utilizar herramientas metálicas.
- Introducir la nueva batería (del tipo indicado en las características técnicas) prestando atención a la polaridad del polo positivo (+) como se indica en el portapila metálico.
- Volver a cerrar la base del transmisor controlando su apoyo correcto en la ranura de la junta puesta en el frontal del transmisor para restablecer la estanqueidad.
- Volver a atornillar los cuatro tornillos.

-  **ATENCIÓN:** después de haber cerrado el transmisor, comprobar su funcionamiento correcto.

 Al final de la vida útil de la batería que contiene el producto, hay que eliminarla por separado respecto a los desechos urbanos no diferenciados. Elimine la batería en conformidad con las disposiciones de leyes locales.

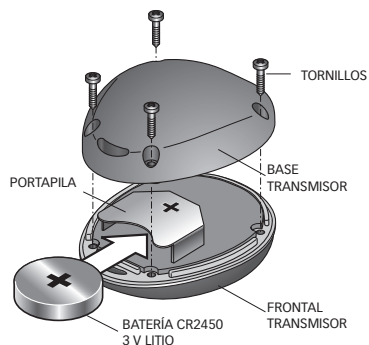

## MANTENIMIENTO

El transmisor de radio de bolsillo RRC Thruster no requiere ningún mantenimiento especial. Para su limpieza utilizar un paño suave humedecido en agua. No utilizar productos químicos o abrasivos.

## ESPECIFICACIONES TÉCNICAS

MODELOS	PW4	PT4
<b>CARACTERÍSTICAS DE ENTRADA</b>		
Alimentación	Batería CR2450 3 V litio	
Absorción en transmisión	13 mA	
<b>CARACTERÍSTICAS DEL TRANSMISOR</b>		
Número de teclas	4	4
Frecuencia portante	434.420 Mhz	
Modulación	FSK	
Conforme con las directivas	2014/53/EU (RED)	
<b>CARACTERÍSTICAS GENERALES</b>		
Temperatura de trabajo	da -15°C a +70°C	
Dimensiones (L x A x P)	60 x 47 x 23 mm	
Peso (incluyendo la batería)	34 g	

QUICK® SE RESERVA EL DERECHO DE APORTAR MODIFICACIONES EN LAS CARACTERÍSTICAS TÉCNICAS DEL APARATO Y EN EL CONTENIDO DE ESTE MANUAL SIN OBLIGACIÓN DE AVISAR PREVIAMENTE.



### TRANSMISSOR RÁDIO DE BOLSO RRC THRUSTER

O transmissor de bolso RRC Thruster é um dispositivo, associado a um receptor de rádio RRC, apto para comandar o funcionamento de propulsores de manobra em embarcações de recreação.

O sistema rádio RRC para propulsores de manobra deve ser utilizado como auxiliar de um sistema a cabo de comando para propulsor de manobra Quick já instalado sobre a embarcação.

⚠ Tome as providências apropriadas para evitar que a falta de funcionamento do sistema de comando rádio RRC Thruster possa provocar danos a pessoas, animais ou coisas.

As vantagens que o transmissor de rádio portátil RRC oferece são:

- Funcionamento controlado por micro-controlador.
- Funcionamento em um amplo intervalo de temperatura ambiente (da -15°C a +70°C).
- Modulação FSK e frequência portadora de 434.420Mhz.
- Indicação através do indicador luminoso do estado de funcionamento, pilha descarregada e feedback de transmissão.
- Flutuante.

### INSTALAÇÃO

⚠ **ANTES DE UTILIZAR O TRANSMISSOR DE RÁDIO LER ATENCIOSAMENTE O PRESENTE MANUAL DE USO. EM CASO DE DÚVIDAS CONTACTAR O REVENDEDOR OU O SERVIÇO CLIENTES QUICK®.**

☞ No caso de discordâncias ou eventuais erros entre o texto traduzido e aquele original em italiano, usar como referência o texto italiano ou inglês.

☞ Este dispositivo foi projectado e realizado para ser utilizado em embarcações de recreio. Não é permitida uma utilização diferente sem a autorização escrita por parte da empresa Quick®.

O transmissor de bolso RRC Thruster foi projetado e realizado para os objetivos descritos neste manual de uso. A sociedade Quick® não assume nenhum tipo de responsabilidade por danos diretos ou indiretos causados pelo uso impróprio do comando do rádio, instalação errada ou possíveis erros presentes neste manual.

**A EMBALAGEM CONTÉM:** transmissor portátil de rádio com as baterias instaladas - lanyard - condições de garantia - o presente manual de Instalação e uso.

### Transmissor portátil

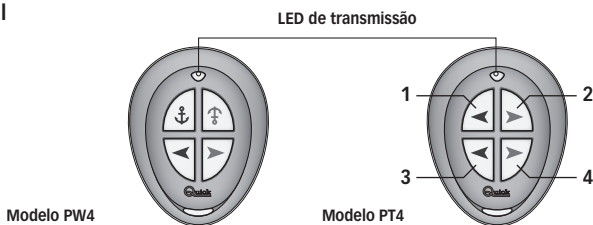

⚠ **ATENÇÃO:** o transmissor deve ser programado na memória do receptor. Seguir o procedimento indicado no manual de uso do receptor.

### Alimentação

O transmissor portátil é alimentado por uma pilha CR2450 ao lítio. Para substituí-la ver o parágrafo SUBSTITUIÇÃO DA PILHA.

### Habilitação

O transmissor de bolso RRC Thruster habilita-se mantendo-se pressionadas ambas as teclas para o modelo PW4 e **1** **2** para o modelo PT4.

Ao pressioná-los inicia-se a piscar o led de transmissão, de cor laranja, com cadência regular para depois passar para uma intermitência veloz. Ao soltá-los o led de transmissão mostrará, com uma intermitência breve, o estado de habilitação efetuada.

### Estado de funcionamento

Durante a pressão de uma tecla qualquer do transmissor o indicador luminoso de transmissão verde pisca rapidamente para sinalizar que foi realizada a transmissão. A cada tecla pressionada corresponde a ativação de um relé (o 2 relé) no receptor que permanecerá ativo até que se solte a botoeira.





## CORRESPONDÊNCIA TECLA PRESSIONADA E RELÉ ATIVADO



**TRANSMISSOR DE BOLSO  
RRC PW4 THRUSTER**

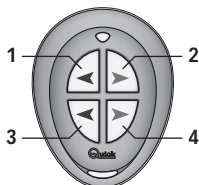



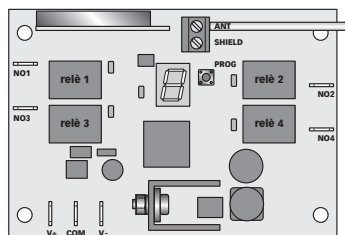



**TRANSMISSOR DE BOLSO  
RRC PT4 THRUSTER**







**RECEPTOR RÁDIO RRC R04**





### Transmissor de bolso RRC PW4 Thruster e receptor rádio RRC R04

A pressão da tecla  (subida âncora) leva à ativação do relé 1 no receptor.  
A pressão da tecla  (descida âncora) leva à ativação do relé 2 no receptor.  
A pressão contemporânea das duas teclas proporciona a anulação da transmissão.

A pressão da tecla  (esquerda proa) leva à ativação do relé 3 no receptor.  
A pressão da tecla  (direita proa) leva à ativação do relé 4 no receptor.  
Introduz-se um atraso de 2 segundos sobre a transmissão quando passa-se da tecla  (esquerda proa) à tecla  (direita proa) e vice versa.  
A pressão contemporânea das duas teclas proporciona a anulação da transmissão.

### Transmissor de bolso RRC PT4 Thruster e receptor rádio RRC R04

A pressão da tecla **1**  (esquerda proa) leva à ativação do relé 1 no receptor.  
A pressão da tecla **2**  (direita proa) leva à ativação do relé 2 no receptor.  
Introduz-se um atraso de 2 segundos sobre a transmissão quando passa-se da tecla **1**  (esquerda proa) à tecla **2**  (direita proa) e vice versa.  
A pressão contemporânea das duas teclas proporciona a anulação da transmissão.

A pressão da tecla **3**  (esquerda popa) leva à ativação do relé 3 no receptor.  
A pressão da tecla **4**  (direita popa) leva à ativação do relé 4 no receptor.  
Introduz-se um atraso de 2 segundos sobre a transmissão quando passa-se da tecla **3**  (esquerda popa) à tecla **4**  (direita popa) e vice versa.  
A pressão contemporânea das duas teclas proporciona a anulação da transmissão.

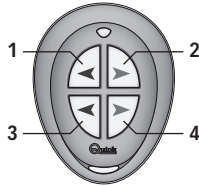
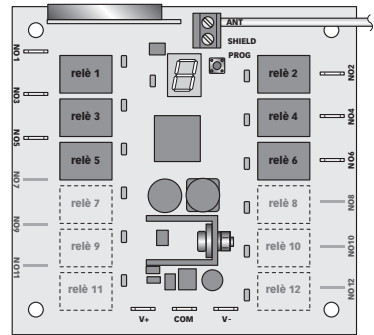

## CORRESPONDÊNCIA TECLA PRESSIONADA E RELÉ ATIVADO

TRANSMISSOR DE BOLSO  
RRC PW4 THRUSTERTRANSMISSOR DE BOLSO  
RRC PT4 THRUSTER

RECEPTOR RÁDIO RRC R06

**Transmissor de bolso RRC PW4 Thruster e receptor rádio RRC R06**

A pressão da tecla ⚓ (subida âncora) leva à ativação do relé 1 no receptor.  
 A pressão da tecla ⚓ (descida âncora) leva à ativação do relé 2 no receptor.  
 A pressão contemporânea das duas teclas proporciona a anulação da transmissão.

A pressão da tecla ◀ (esquerda proa) leva à ativação do relé 3 no receptor.  
 A pressão da tecla ▶ (direita proa) leva à ativação do relé 4 no receptor.  
 Introdz-se um atraso de 2 segundos sobre a transmissão quando passa-se da tecla ◀ (esquerda proa) à tecla ▶ (direita proa) e vice versa.  
 A pressão contemporânea das duas teclas proporciona a anulação da transmissão.

**Transmissor de bolso RRC PT4 Thruster e receptor rádio RRC R06**

A pressão da tecla 1 ◀ (esquerda proa) leva à ativação do relé 3 no receptor.  
 A pressão da tecla 2 ▶ (direita proa) leva à ativação do relé 4 no receptor.  
 A pressão contemporânea das duas teclas proporciona a anulação da transmissão.  
 Introdz-se um atraso de 2 segundos sobre a transmissão quando passa-se da tecla 1 ◀ (esquerda proa) à tecla 2 ▶ (direita proa) e vice versa.





A pressão da tecla 3 ◀ (esquerda popa) leva à ativação do relé 5 no receptor.  
 A pressão da tecla 4 ▶ (direita popa) leva à ativação do relé 6 no receptor.  
 Introdz-se um atraso de 2 segundos sobre a transmissão quando passa-se da tecla 3 ◀ (esquerda popa) à tecla 4 ▶ (direita popa) e vice versa.  
 A pressão contemporânea das duas teclas proporciona a anulação da transmissão.



## Desabilitação do transmissor

A desabilitação do transmissor, que se encontra no estado de funcionamento, pode ocorrer de modo automático e manual.

Modo automático: se em 3 minutos não forem pressionadas as teclas o transmissor será desabilitado e o LED de transmissão será apagado.

Modo manual: o transmissor pode ser desabilitado mesmo de modo manual sem aguardar os 3 minutos necessários. Mantenha pressionadas ambas as teclas   para o modelo PW4 e **1**  **2**  para o modelo PT4. O LED de transmissão, de cor laranja, mostrará uma intermitência regular para depois apagar-se e sinalizar a desabilitação efetuada do transmissor.

## Sinalização de pilha descarregada

Aconselha-se a substituição da pilha em breve se, durante o estado de funcionamento, a cor do indicador luminoso de transmissão for vermelha. O tempo de autonomia residual depende do tipo e da qualidade da pilha utilizada.

## SUBSTITUIÇÃO DA PILHA

 **ATENÇÃO:** perigo de explosão se a bateria é substituída por outra de tipo errado.

 **ATENÇÃO:** Antes de operar no transmissor verificar se o receptor de rádio RRC está alimentado. A pressão involuntária de uma tecla pode acionar o correspondente utilizador e criar situações de perigo.

- Remover a base do transmissor, desaparafusando os quatro parafusos com uma chave de fendas estrela.
- Remover a pilha do porta-pilhas, fazendo-a deslizar para o lado de fora e evitar a utilização de utensílios metálicos.
- Inserir a pilha nova (do tipo indicado nas características técnicas) e prestar atenção na polaridade do polo positivo (+), como indicado no porta-pilhas metálico.
- Fechar novamente a base do transmissor e controlar o apoio correto nas ranhuras da guarnição presentes na frente do transmissor para restabelecer o fechamento.
- Reaparafusar os quatro parafusos.

 **ATENÇÃO:** verificar, após o fechamento, se o transmissor funciona corretamente.

 No final do seu ciclo de vida, a bateria colocada no produto deve ser eliminada separadamente de outros detritos urbanos não diferenciados. Eliminar a bateria em conformidade com as leis locais.

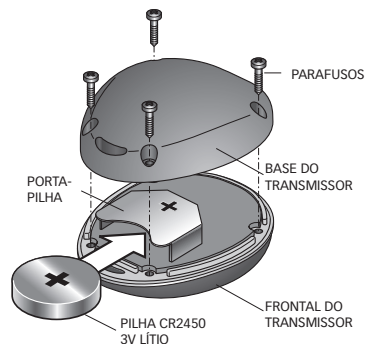

## MANUTENÇÃO

O transmissor rádio de bolso RRC Thruster não solicita uma especial manutenção. Para a limpeza utilizar um pano macio e umedecido com água. Não utilizar produtos químicos ou abrasivos.

## DADOS TÉCNICOS

MODELOS	PW4	PT4
<b>CARACTERÍSTICAS DE ENTRADA</b>		
Alimentação	Pilha CR2450 3V lítio	
Absorção em transmissão	13 mA	
<b>CARACTERÍSTICAS DO TRANSMISSOR</b>		
Número de teclas	4	4
Frequência portadora	434.420 Mhz	
Modulação	FSK	
Em conformidade com as diretivas	2014/53/EU (RED)	
<b>CARACTERÍSTICAS GERAIS</b>		
Temperatura operacional	de -15°C a +70°C	
Dimensões (L x A x P)	60 x 47 x 23 mm	
Peso (com pilha)	34 g	

A QUICK® SE RESERVA O DIREITO DE FAZER MODIFICAÇÕES NAS CARACTERÍSTICAS DO APARELHO E NO CONTEÚDO DESTES MANUAIS SEM NENHUM AVISO PRÉVIO.



## FICKRADIOSÄNDARE RRC THRUSTER

Ficksändaren RRC Thruster är en enhet som, kombinerad med en RRC radiomottagare, reglerar driften av utrustning eller tillbehör installerade på fritidsbåtar.

Radiosystemet RRC för bogpropellrar ska användas som tillbehör till ett sladdsystem för bogpropellrar från Quick som redan sitter installerade på båten.

Vidta nödvändiga åtgärder för att undvika att ett eventuellt funktionsfel på radiosystemet RRC Thruster kan förorsaka skador på personer, djur eller föremål.

Fördelarna som RRC radiosändare i fickformat erbjuder är:

- Driften hanteras av en mikrokontroller.
- Drift i ett brett spektrum av temperaturer (från -15°C till +70°C).
- FSK modulering och bärfrekvens på 434.420 Mhz.
- LED indikation om driftstatus, batteristatus och sändnings feed-back.
- Flytande.

## INSTALLATION

**LÄS NOGA IGENOM DENNA BRUKSANVISNING INNAN DU ANVÄDER RADIOSÄNDAREN. VID TVEKAN SÅ KONTAKTA ER ÅTERFÖRSÄLJARE ELLER KUNDTJÄNSTEN FÖR QUICK®.**

Vid avvikelser eller eventuella fel mellan översatt text och original texten på italienska så hänvisas till den italienska eller engelska texten.

Detta system har utförts och tillverkats för att användas på fritidsbåtar. All annan användning är otillåten utan en skriftlig auktorisering från företaget Quick®.

Ficksändaren RRC Thruster har framtagits och utförts för de ändamål som finns beskrivna i denna bruksanvisning. Företaget Quick® åtager sig inget ansvar för direkta eller indirekta skador som orsakats vid olämplig användning av utrustningen, av en felaktig installation eller möjliga fel i denna bruksanvisning

**FÖRPACKNINGEN INNEHÅLLER:** radiosändare i fickformat med batteri installerat - lanyard - garantivillkor - bruks och installationsanvisning.

## Sändare i fickformat

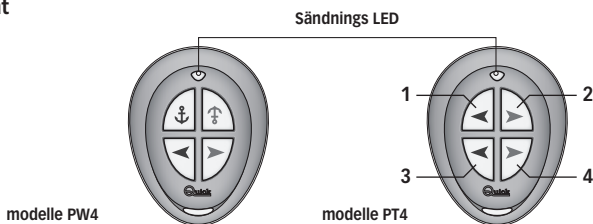

**VARNING:** Sändaren måste programmeras i mottagarens minne. Följ instruktionerna i bruksanvisningen för mottagaren.

## Energiförsörjning

Sändaren i fickformat drivs med ett CR2450 litiumbatteri. För utbyte se avsnittet om BATTERIBYTE.

## Aktivering

Ficksändaren RRC Thruster aktiveras genom att hålla intryckta båda knapparna för modellen PW4 och för modellen PT4.

När de trycks in börjar sändarlampan att blinka med orange färg i regelbunden takt, för att sedan blinka snabbare. När de släpps blinkar sändarlampan till kort för att visa att den är aktiverad.

## Driftstatus

När man trycker på en knapp på sändaren så kommer en grön sändnings LED att blinka snabbt för att signalera en lyckad överföring. Varje tryck på en tangent motsvarar aktiveringen av ett relä (eller 2 relä) på mottagaren som förblir aktiv tills du släpper knappen.

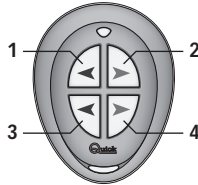
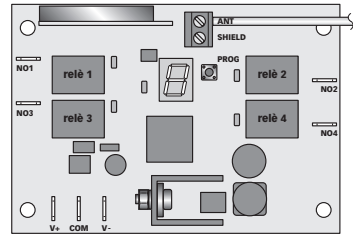
**MOTSVARIGHET INTRYCKT KNAPP OCH AKTIVERAT RELÄ****FICKRADIOSÄNDARE  
RRC PW4 THRUSTER****FICKRADIOSÄNDARE  
RRC PT4 THRUSTER****RADIOMOTTAGARE RRC R04****Ficksändare RRC PW4 Thruster och radiomottagare RRC R04**



När man trycker in knappen  (hissa ankare) aktiveras relä 1 på mottagaren.

När man trycker in knappen  (sänk ankare) aktiveras relä 2 på mottagaren.

Om båda knapparna trycks in samtidigt annulleras sändningen.

När man trycker in knappen  (vänster för) aktiveras relä 3 på mottagaren.

När man trycker in knappen  (höger för) aktiveras relä 4 på mottagaren.



En transmissionsfördröjning på 2 sekunder sker då man går från knappen  (vänster för) till knappen  (höger för) och viceversa.

Om båda knapparna trycks in samtidigt annulleras sändningen.

**Ficksändare RRC PT4 Thruster och radiomottagare RRC R04**

När man trycker in knappen **1**  (vänster för) aktiveras relä 1 på mottagaren.



När man trycker in knappen **2**  (vänster för) aktiveras relä 2 på mottagaren.

En transmissionsfördröjning på 2 sekunder sker då man går från knappen **1**  (vänster för) till knappen **2**  (höger för) och viceversa.

Om båda knapparna trycks in samtidigt annulleras sändningen.

När man trycker in knappen **3**  (vänster akter) aktiveras relä 3 på mottagaren.

När man trycker in knappen **4**  (höger akter) aktiveras relä 4 på mottagaren.

En transmissionsfördröjning på 2 sekunder sker då man går från knappen **3**  (vänster akter) al tasto **4**  (höger akter) och viceversa.

Om båda knapparna trycks in samtidigt annulleras sändningen.

**MOTSVARIGHET INTRYCKT KNAPP OCH AKTIVERAT RELÄ**

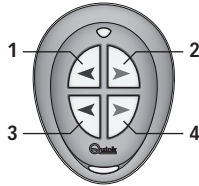
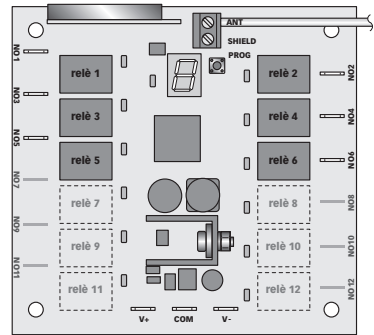
**FICKRADIOSÄNDARE  
RRC PW4 THRUSTER**

**FICKRADIOSÄNDARE  
RRC PT4 THRUSTER**

**RADIOMOTTAGARE RRC R06**
**Radiosändare i fickformat RRC PW4 Thruster och radiomottagare RRC R06**



När man trycker in knappen  (hissa ankare) aktiveras relä 1 på mottagaren.

När man trycker in knappen  (sänk ankare) aktiveras relä 2 på mottagaren.

Om båda knapparna trycks in samtidigt annulleras sändningen.

När man trycker in knappen  (vänster för) aktiveras relä 3 på mottagaren.

När man trycker in knappen  (höger för) aktiveras relä 4 på mottagaren.

En transmissionsfördröjning på 2 sekunder sker då man går från knappen  (vänster för) till knappen  (höger för) och viceversa.



Om båda knapparna trycks in samtidigt annulleras sändningen.

**Radiosändare i fickformat RRC PT4 Thruster och radiomottagare RRC R06**

När man trycker in knappen **1**  (vänster för) aktiveras relä 3 på mottagaren.



När man trycker in knappen **2**  (höger för) aktiveras relä 4 på mottagaren.

Om båda knapparna trycks in samtidigt annulleras sändningen.

En transmissionsfördröjning på 2 sekunder sker då man går från knappen **1**  (vänster för) till knappen **2**  (höger för) och viceversa.

När man trycker in knappen **3**  (vänster akter) aktiveras relä 5 på mottagaren.

När man trycker in knappen **4**  (höger akter) aktiveras relä 6 på mottagaren.

En transmissionsfördröjning på 2 sekunder sker då man går från knappen **3**  (vänster akter) till knappen **4**  (höger akter) och viceversa.





Om båda knapparna trycks in samtidigt annulleras sändningen.



## Disaktivering av sändaren

Disaktivering av sändaren, som är i funktion, kan ske automatiskt och manuellt.

Automatiskt: om sändarknapparna inte trycks in inom 3 minuter deaktiveras den och sändarlampan släcks.

Manuellt: sändaren kan även disaktiveras manuellt utan att vänta i 3 minuter. Håll intryckta båda knapparna   för modellen PW4 och   för modellen PT4. Den orangea sändarlampan blinkar regelbundet och släcks sedan för att visa att sändaren stängts av.

## Batterivarning

Vi rekommenderar att byta ut batteriet fortast möjligt om sändnings LED visar rött under operativ status. Den tid som återstår av laddningen beror på batterityp och kvaliteten.

## BATTERIBYTE

 **VARNING:** risk för explosion om batteriet byts ut mot ett av fel typ.

 **VARNING:** innan du gör ett ingrepp på sändaren kontrollera att RRC radiomottagaren inte är påslagen. Att oavsiktligt trycka på en knapp kan innebära fara för användaren.

- Ta bort basen från sändaren genom att skruva av de fyra skruvarna.
- Ta ur batterierna från batterihållaren genom att skjuta den utåt utan att använda metallredskap
- Sätt in nya batterier (av den typ som anges i den tekniska beskrivningen) med särskild uppmärksamhet på den positiva (+) polen som angavs på batterihållaren.
- Stäng igen basen och försäkra dig om att locket sätts på korrekt och att packningen sitter som den ska för att återställa förseglingen.
- Skruva tillbaka skruvarna.

 **VARNING:** verifiera att sändaren fungerar som den ska.

 När dess livslängd har tagit slut ska batteriet som produkten innehåller bortskaffas separat och inte kastas med det vanliga brännbara hushållsavfallet. Kassera batteriet i enlighet med nationell lagstiftning.

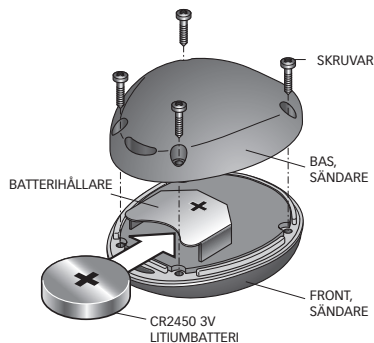

## UNDERHÅLLSARBETE

Fickradiosändaren RRC Thruster kräver inget speciellt underhåll. För rengöring använd en mjuk trasa fuktad med vatten. Använd inte kemikalier eller slipmedel.

## TEKNISKA EGENSKAPER

MODELLER	PW4	PT4
<b>EGENSKAPER FÖR INGÅNG</b>		
Energiförsörjning	CR2450 3V litiumbatteri	
Sändningsabsorption	13 mA	
<b>SÄNDARENS EGENSKAPER</b>		
Antal knappar	4	4
Bärfrekvens	434.420 Mhz	
Modulering	FSK	
Uppfyller	2014/53/EU (RED)	
<b>ALLMÄNNA EGENSKAPER</b>		
Operativ temperatur	från -15°C till +70°C	
Dimensioner (L x A x P)	60 x 47 x 23 mm	
Vikt (inklusive batteri)	34 g	

QUICK® RESERVERAR SIG RÄTTEN ATT UTAN VIDARE MEDELÄNDE UTFÖRA TEKNISKA MODIFIERINGAR PÅ APPARATEN OCH LIKASÅ INNEHÅLLET I DENNA BRUKSANVISNING.



### RRC POCKETRADIOZENDER THRUSTER

De pocketzender RRC Thruster is een toestel gekoppeld aan een RRC radio-ontvanger, om de werking van apparaten of accessoires te bedienen, geïnstalleerd op pleziervaartuigen.

Het radiosysteem RRC voor motoren moet, als hulp, gebruikt worden samen met een bekabeld bedieningssysteem voor motoren Quick, reeds geïnstalleerd op de boot.

 Neem de nodige voorzorgsmaatregelen in acht om te voorkomen dat een defect van het bedieningssysteem via radio RRC Thruster schade kan berokkenen aan personen, dieren of voorwerpen.

De voordelen die de RRC pocketradiozender Thruster biedt, zijn:

- Werking beheerd door microcontroller.
- Werking binnen een breed interval van omgevingstemperatuur ( van -15°C tot +70°C).
- Modulatie FSK en draagfrequentie 434.420Mhz.
- Indicatie via LED van de werkingsstatus, lege batterij en transmissiefeedback.
- Vlotter.

### INSTALLATIE

 **VOORALEER DE RADIOZENDER TE GEBRUIKEN, LEES AANDACHTIG DEZE GEBRUIKSAANWIJZING. NEEM BIJ TWIJFEL CONTACT OP MET DE VERKOPER OF DE QUICK®-KLANTENSERVICE.**

 In het geval van fouten of verschillen tussen de vertaling en de originele Italiaanse tekst, is de Italiaanse of de Engelse tekst doorslaggevend.

 Dit apparaat is ontworpen en uitgevoerd om te worden gebruikt op pleziervaartuigen. Ander gebruik is niet toegestaan zonder schriftelijke toestemming van Quick®.

De pocketzender RRC Thruster werd ontworpen en ontwikkeld voor de doeleinden beschreven in deze handleiding.

De firma Quick® acht zich niet verantwoordelijk voor rechtstreekse of onrechtstreekse schade veroorzaakt door een onjuist gebruik van de radiobesturing, door een foutieve installatie of door mogelijke fouten in deze handleiding.

**DE VERPAKKING BEVAT:** pocketradiozender inclusief batterij - lanyard - garanti voorwaarden - gebruikers en installatie handleiding.

### Pocketzender

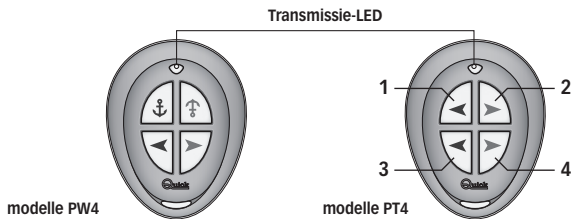

 **LET OP:** de zender wordt in het geheugen van de ontvanger geprogrammeerd. Volg de procedure beschreven in de handleiding voor gebruik van de ontvanger.

### Voeding

De pocketzender wordt gevoed via een CR2450 lithiumbatterij. Voor het vervangen, raadpleeg de paragraaf VERVANGING VAN DE BATTERIJ.

### Activering

De pocketzender RRC Thruster wordt aangezet door beide toetsen   voor het model PW4 en   voor het model PT4 ingedrukt te houden.

Wanneer erop gedrukt wordt, begint de oranje transmissieled met een regelmatig ritme en vervolgens snel te knipperen. Bij het loslaten zal de transmissieled kort knipperen om aan te geven dat de zender aan is.

### Werkingsstatus

Wanneer op een willekeurige toets van de zender wordt gedrukt, gaat de transmissie LED snel groen knipperen om aan te geven dat de transmissie gebeurd is. Met iedere ingedrukte toets komt de activering overeen van een relais (of 2 relais) op de ontvanger welke actief blijft zolang de knop ingedrukt is

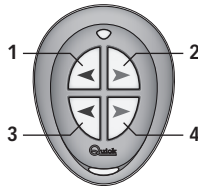
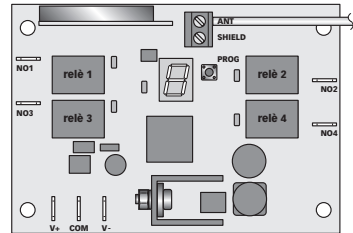

**OVEREENKOMST INGEDRUKTE TOETS EN GEACTIVEERD RELAIS****POCKETZENDER  
RRC PW4 THRUSTER****POCKETZENDER  
RRC PT4 THRUSTER****RADIO-ONTVANGER RRC R04****Pocketzender RRC PW4 Thruster en radio-ontvanger RRC R04**



Door te drukken op de toets  (anker omhoog) wordt relais 1 op de ontvanger geactiveerd.

Door te drukken op de toets  (anker omlaag) wordt relais 2 op de ontvanger geactiveerd.

Door tegelijk op beide toetsen te drukken, wordt de transmissie teniet gedaan.

Door te drukken op de toets  (links boeg) wordt relais 3 op de ontvanger geactiveerd.

Door te drukken op de toets  (rechts boeg) wordt relais 4 op de ontvanger geactiveerd.

Er moet rekening gehouden worden met een vertraging van 2 seconden bij de transmissie wanneer men overschakelt van toets  (links boeg) op toets  (rechts boeg) en omgekeerd.

Door tegelijk op beide toetsen te drukken, wordt de transmissie teniet gedaan.

**Pocketzender RRC PT4 Thruster en radio-ontvanger RRC R04**

Door te drukken op de toets **1**  (links boeg) wordt relais 1 op de ontvanger geactiveerd.



Door te drukken op de toets **2**  (rechts boeg) wordt relais 2 op de ontvanger geactiveerd.

Er moet rekening gehouden worden met een vertraging van 2 seconden bij de transmissie wanneer men overschakelt van toets **1**  (links boeg) op toets **2**  (rechts boeg) en omgekeerd.

Door tegelijk op beide toetsen te drukken, wordt de transmissie teniet gedaan.

Door te drukken op de toets **3**  (links achterstevan) wordt relais 3 op de ontvanger geactiveerd.

Door te drukken op de toets **4**  (rechts achterstevan) wordt relais 4 op de ontvanger geactiveerd.

Er moet rekening gehouden worden met een vertraging van 2 seconden bij de transmissie wanneer men overschakelt van toets **3**  (links achterstevan) op toets **4**  (rechts achterstevan) en omgekeerd.

Door tegelijk op beide toetsen te drukken, wordt de transmissie teniet gedaan.



OVEREENKOMST INGEDRUKTE TOETS EN GEACTIVEERD RELAIS



POCKETZENDER  
RRC PW4 THRUSTER

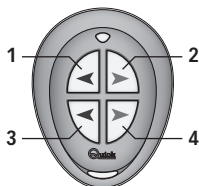

POCKETZENDER  
RRC PT4 THRUSTER

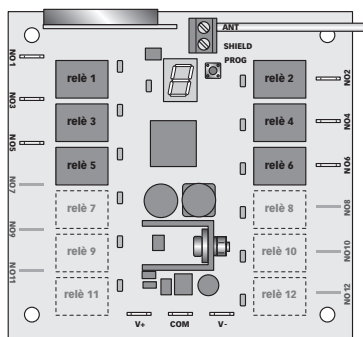

RADIO-ONTVANGER RRC R06

**Pocketzender RRC PW4 Thruster en radio-ontvanger RRC R06**

Door te drukken op de toets (anker omhoog) wordt relais 1 op de ontvanger geactiveerd.

Door te drukken op de toets (anker omlaag) wordt relais 2 op de ontvanger geactiveerd.

Door tegelijk op beide toetsen te drukken, wordt de transmissie teniet gedaan.

Door te drukken op de toets (links boeg) wordt relais 3 op de ontvanger geactiveerd.

Door te drukken op de toets (rechts boeg) wordt relais 4 op de ontvanger geactiveerd.

Er moet rekening gehouden worden met een vertraging van 2 seconden bij de transmissie wanneer men overschakelt van toets (links boeg) op toets (rechts boeg) en omgekeerd.

Door tegelijk op beide toetsen te drukken, wordt de transmissie teniet gedaan.

**Pocketzender RRC PT4 Thruster en radio-ontvanger RRC R06**

Door te drukken op de toets 1 (links boeg) wordt relais 3 op de ontvanger geactiveerd.

Door te drukken op de toets 2 (rechts boeg) wordt relais 4 op de ontvanger geactiveerd.

Er moet rekening gehouden worden met een vertraging van 2 seconden bij de transmissie wanneer men overschakelt van toets 1 (links boeg) op toets 2 (rechts boeg) en omgekeerd.

Door tegelijk op beide toetsen te drukken, wordt de transmissie teniet gedaan.

Door te drukken op de toets 3 (links achterstevan) wordt relais 5 op de ontvanger geactiveerd.

Door te drukken op de toets 4 (rechts achterstevan) wordt relais 6 op de ontvanger geactiveerd.

Er moet rekening gehouden worden met een vertraging van 2 seconden bij de transmissie wanneer men overschakelt van toets 3 (links achterstevan) op toets 4 (rechts achterstevan) en omgekeerd.





Door tegelijk op beide toetsen te drukken, wordt de transmissie teniet gedaan.



## Deactivering van de zender

Het deactiveren van de zender die zich in de werkingsstatus bevindt, kan op automatische en op manuele wijze gebeuren.

Automatische wijze: indien binnen de 3 minuten op geen enkele toets gedrukt werd, schakelt de zender uit en gaat ook de transmissieled uit.

Manuele wijze: de zender kan ook manueel gedeactiveerd worden zonder 3 minuten te wachten. Houd beide toetsen   voor het model PW4 en **1**  **2**  voor het model PT4 ingedrukt. De oranje transmissieled zal eerst regelmatig knipperen en dan uitgaan om aan te geven dat de zender uit staat.

## Signalering lege batterij

Het is aanbevolen om de batterij zo snel mogelijk te vervangen als het kleur van het transmissie-LED tijdens de werkingsstatus rood is. De resterende tijd in autonomie hangt af van de kwaliteit van de gebruikte batterij.

## VERVANGING VAN DE BATTERIJ

 **LET OP:** ontploffingsgevaar indien de batterij wordt vervangen door een andere batterij van het verkeerde type.

 **LET OP:** vooraleer interventies op de zender uit te voeren, moet men controleren of de RRC radio-ontvanger niet gevoed is. Een onopzettelijke druk op een toets zou het corresponderende instrument kunnen activeren en tot gevaarlijke situaties leiden.

- Verwijder de basis van de zender door de vier schroeven met een sterschroevendraaier los te draaien.
- Verwijder de batterij uit de batterijhouder door ze naar buiten te laten rollen, vermijd hierbij het gebruik van metalen gereedschap.
- Plaats de nieuwe batterij (type zoals aangegeven in de technische kenmerken), let daarbij op de polariteit van de positieve pool (+) zoals aangeduid op de metalen batterijdrager.
- Sluit opnieuw de basis van de zender en controleer of die correct aansluit in de groef van de dichting op de voorkant van de zender, om opnieuw te zorgen dat die hermetisch gesloten is.
- Zet de vier schroeven opnieuw vast.

 **LET OP:** als de zender opnieuw dicht is, moet men controleren of hij correct werkt.

 Op het einde van zijn levenscyclus moet de batterij die in het product zit afzonderlijk worden verwijderd, gescheiden van ander, niet-gescheiden huishoudelijk afval. De batterij verwerken in overeenstemming met de bepalingen van de plaatselijke wetten.

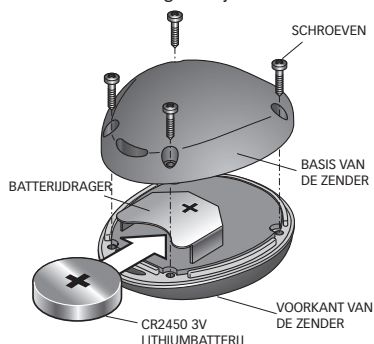

## ONDERHOUD

De pocketradiozender RRC Thruster vereist geen speciaal onderhoud. Gebruik een zachte doek gedrenkt in water voor de schoonmaak. Gebruik geen chemische of schurende middelen.

## TECHNISCHE KENMERKEN

MODELLEN	PW4	PT4
<b>INGANGSKENMERKEN</b>		
Voeding	CR2450 3V lithiumbatterij	
Absorptie bij transmissie	13 mA	
<b>KENMERKEN VAN DE ZENDER</b>		
Aantal toetsen	4	4
Draaffrequentie	434.420 Mhz	
Modulatie	FSK	
Conform met de richtlijnen	2014/53/EU (RED)	
<b>ALGEMEEN</b>		
Bedrijfstemperatuur	van -15°C tot +70°C	
Afmetingen (L x H x D)	60 x 47 x 23 mm	
Gewicht (batterij inbegrepen)	34 g	

QUICK\* BEHOUDT ZICH HET RECHT WIJZIGINGEN AAN TE BRENGEN AAN DE TECHNISCHE EIGENSCHAPPEN VAN HET APPARAAT EN AAN DE INHOUD VAN DEZE HANDLEIDING ZONDER VOORVERMELDING.

## RRC DIMENSIONI (mm)



DIMENSIONS - DIMENSIONS - ABMESSUNGEN - DIMENSIONES - DIMENSÕES - DIMENSIONER - AFMETINGEN

### • PW4

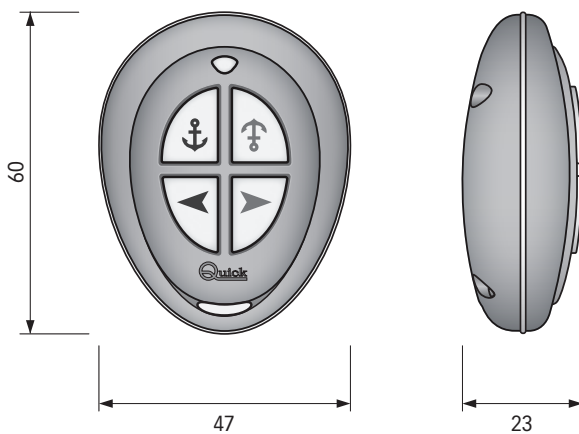

### • PT4

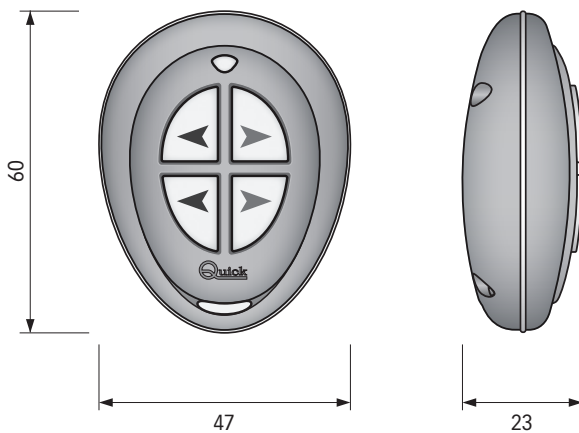

---

NOTES



---

---

---

---

---

---

---

---

---

---

---

---

---

---

---

---

---

---

---

NOTES



---

---

---

---

---

---

---

---

---

---

---

---

---

---

---

---

---

---



# RRC PW4/PT4

## RADIO REMOTE CONTROL THRUSTER POCKET TRANSMITTER

R003A

- IT** Codice e numero seriale del prodotto
- EN** Product code and serial number
- FR** Code et numéro de série du produit
- DE** Code- und Seriennummer des Produkts
- ES** Código y número de serie del producto
- PT** Código e número de série do produto
- SE** Kod och produktens serienummer
- NL** Code en serienummer van het product

 **QUICK**<sup>®</sup> SPA

QUICK<sup>®</sup> S.p.A. - Via Piangipane, 120/A - 48124 Piangipane (RA) - ITALY  
Tel. +39.0544.415061 - Fax +39.0544.415047

[www.quickitaly.com](http://www.quickitaly.com)