

Excess 12

OPTION GUIDE

Dear Dealer,

This document contains all the essential information you will need to understand and talk about options available aboard the EXCESS 12.

01. SAIL AWAY Pack
02. Sailing experience
03. Outside experience
04. Inside experience
05. Technical equipment
06. Accessories

The document refers to equipment from Price List B2022.

This support is a professional tool for your use only. Thank you to not forward it directly to clients but use it to improve your personal knowledge and to perform during client meetings.

This tool will be regularly upgraded according to model year changes and supplier evolutions. Please check regularly for updates. Last upgrade is indicated at the bottom of this page.

Remember, the Sales Guide is about product overview and key client benefits. For option details, please refer to this Options Guide. For technical information, please refer to your Technical Guide.

Enjoy your reading !

The Excess team

Indice A
SEPTEMBER 2021 EDITION



- 01** SAIL AWAY PACK
- 02** SAILING EXPERIENCE
- 03** OUTSIDE EXPERIENCE
- 04** INSIDE EXPERIENCE
- 05** TECHNICAL EQUIPMENT
- 06** ACCESSORIES



01

SAIL AWAY

Electric Pack

RAYMARINE Electronics 2021

Starboard double helm seat

Aft porthole in aft cabins with curtains

Lateral porthole in galley

Opening hatches on forward roof windows

Lifeline openings

SAIL AWAY is an entry level finishing including options and packs.

ELECTRIC PACK

1 - Two additional service batteries 140A



Service battery bank

STANDARD	SAIL AWAY	TOTAL
2 x 140A [AGM]	+ 2 x 140A [AGM]	4 x 140A [AGM]

[AGM std version available from 12#025]

Location onboard underneath the bed [aft port cabin]

2 - Additional 40A charger



40A battery charger | CRISTEC

Charges service batteries and engine

STANDARD	SAIL AWAY	TOTAL
40A	+ 40A	2 x 40A

Location onboard on engine port compartment

3 - Battery controller



Power supply, charge level, lifespan.

A dedicated extra sensor allow to monitor the batteries lifespan and alert for replacing.

ELECTRIC PACK

4 - Shore Power 32A

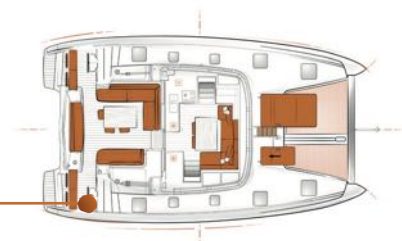

5 - [230V outlet + double USB sockets] in cabins & 230V outlet / USB sockets in salon

LOCATION ON BOARD

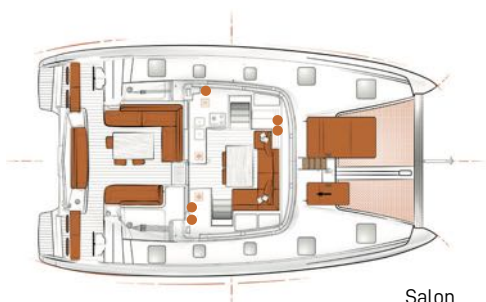

Salon

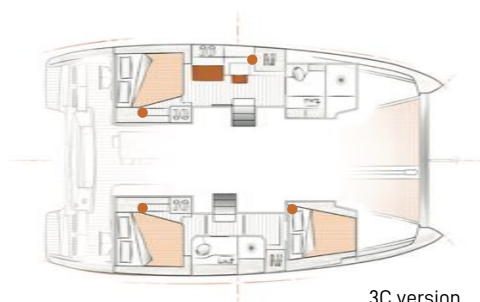

3C version

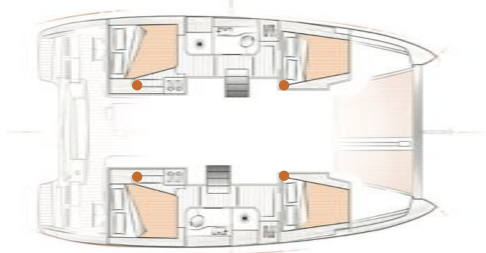

4C2T version

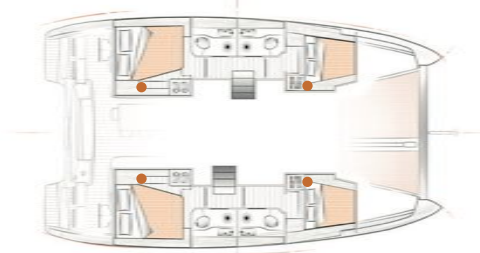

4C4T version

Salon and galley : x5

Per cabin: x1

Owner's cabin: x2



1 - Wind transducer

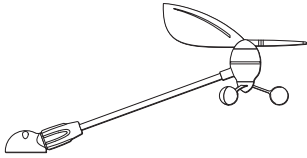

Raymarine Model: E22078

2 - Speed|Depth|Temp. Smart Transducer

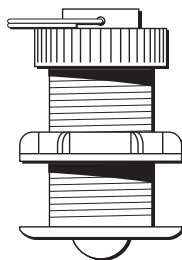
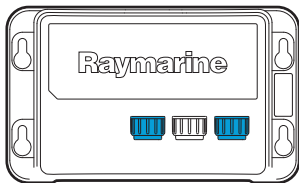

Raymarine Model : A22111

3 - Autopilot

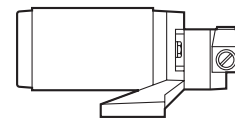
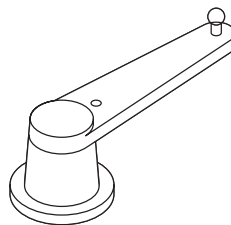
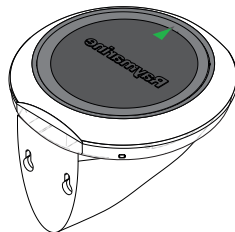
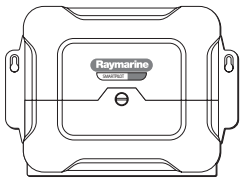

EV-1 9-axis compass sensor with built-in rate gyro.

ACU-400 actuator control unit and Rudder Reference

Raymarine Model: E70096 + E70100

L&S Hydraulic linear drive unit

4 - Equipment at starboard helm station [starboard GRP console included]

P70s

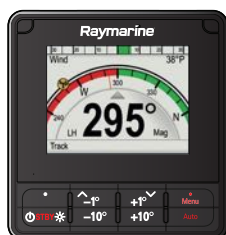

P70s Autopilot Control Head
Raymarine Model: E70331

I70s



I70s Colour instrument
Raymarine Model : E70330

i70s High-resolution colour display showing digital analogue and graphical formats with LightHouse III user interface.

5 - Portative compass



- 1 portative compass
- 2 supports
- 1 black clutch bag

NAVICOM Model : Compas 70UN Universal

STARBOARD DOUBLE HELM SEAT



Double foldable seat on starboard helm station
Option includes a cover.

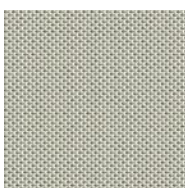

Color: Grey
FERRARI® Batyline Lounge Quartz
7720FR-50932



Color: Orange
SUNBRELLA® Mezzo Tigerlily
MEZZ 10222 140

AFT PORTHOLE IN AFT CABINS WITH CURTAINS



[Starboard]



[Port]

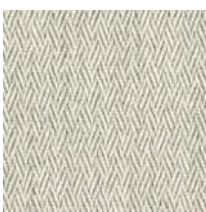

CURTAINS

Color: Beige
SLEEP IN
Serenity-23-Whisper

OPENING PORTHOLE

LEWMAR - Standard Portlight Size 1
Dimensions : 347 L x 171 W mm | 1'1" x 0'6"

LATERAL PORTHOLE IN GALLEY

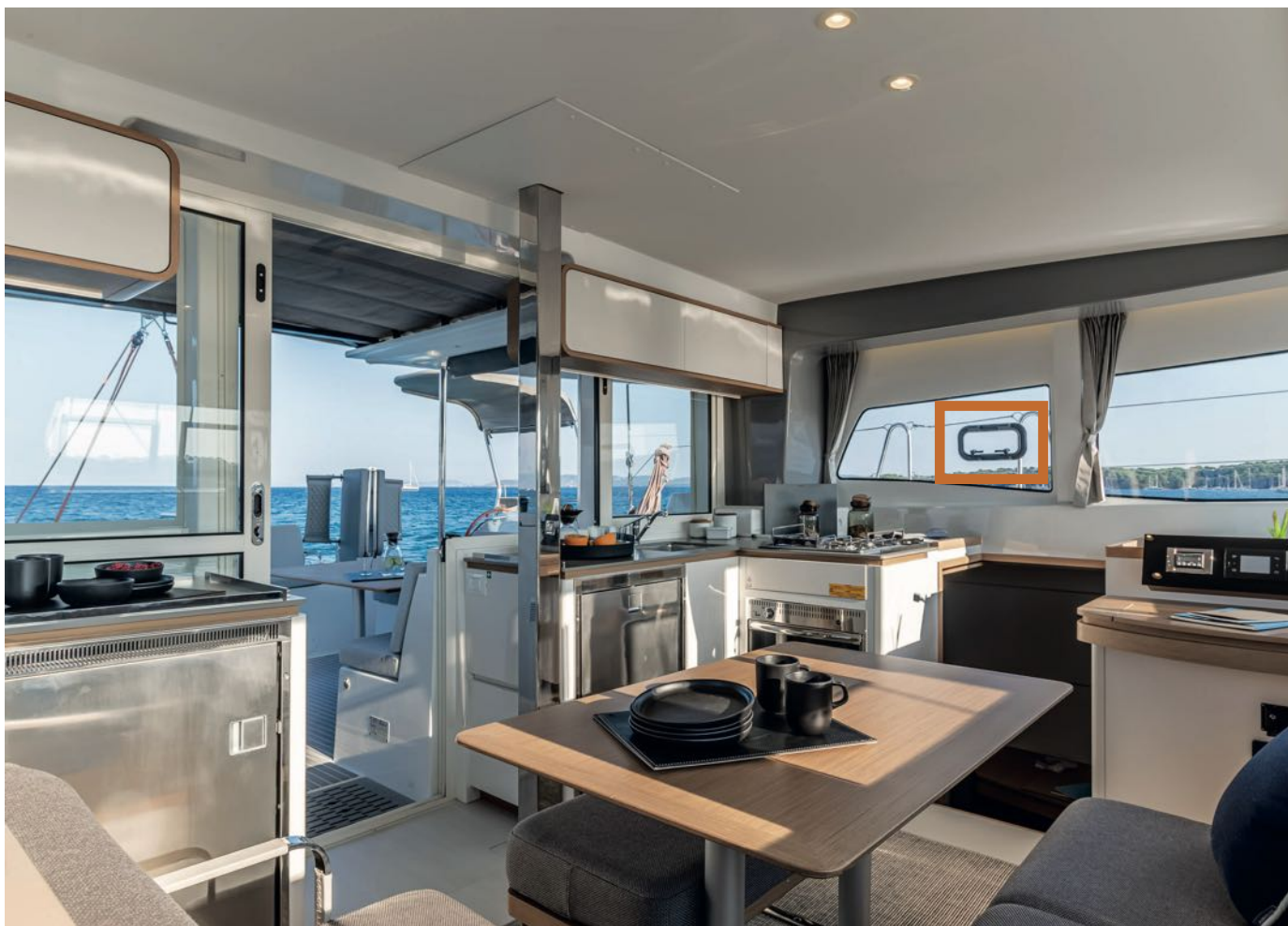

x1 **opening hatch** located on galley on portside.

LEWMAR - Portlight Concept 3

Dimensions : 304 L x 156 W mm | 0'11" x 0'6"

2 OPENING HATCHES ON FORWARD ROOF WINDOWS



x2 **Opening hatches** on central forward roof windows, in the salon.

LEWMAR - Flush Mitre Portlight
Dimensions : 482 L x 342 W mm | 1'6" x 1'1"

LIFELINE OPENINGS



Standard: Stainless steel lifelines

SAIL AWAY: Stainless steel lifeline **openings**
[1 on portside and 1 on starboard]

02

SAILING EXPERIENCE

RIGGING AND SAILS

PULSE LINE [Pack]

Extra for aft starboard electric 40.2 winch

Extra for starboard 46.2 electric winch

Extra for port 46.2 electric winch

Code 0 Rig and Pole & Furler [Standard sail plan]

Asymmetrical spinnaker gear [Standard sail plan]

Code 0 in Mylar

Asymmetrical spinnaker with socket

Lazy bag

ELECTRONICS

RAYMARINE Electronic Upgrade Pack

Upgrade for AXIOM 12" display

AIS 700 RAYMARINE transceiver with antenna coupling

RAYMARINE radar 4Q Quantum

RAYMARINE RealVision sounder

RAYMARINE pilote smart controller

VHF RAYMARINE single handset

2nd Wireless handset for VHF RAYMARINE

VHF RAYMARINE single handset

THE CHOICE OF BOLD SAILORS SEEKING SENSATIONS!

The PULSE LINE is undoubtedly an exciting pack from design point of view to sailing experience! You can sail faster, enjoy sporty sail trimming and a definitively eye-catching design.



The PULSE LINE Pack includes the following options:

- 1 - PULSE LINE **Rigging & Sails plan**
- 2 - **Square top mainsail and self-tacking jib** in pro-radial [Color: grey]
- 3 - **Code 0 rig and pole & furler** [Additional manual winch on port included]
- 4 - **3rd reef**
- 5 - **Barber hauler**
- 6 - **Textile** lifelines
- 7 - PULSE LINE **steering wheels** [Color: Orange]
- 8 - PULSE LINE **hull decoration**

1 - Rigging & Sails plan

With PULSE LINE, the mast configuration [Std: 15.1 m | 49'6" ; PULSE LINE: 15.9 m | 52'1"] offers a great sails plan with a **larger**:

- Mainsail
- Self-tacking jib
- Code 0 **SAIL** [The option is NOT included in this pack]



PULSE LINE increases SA/DSPL 7%, moving the ratio to 4,43, almost 4% above standard. On the water there will be regularly a positive difference above 4%.

■ PULSE LINE - Code 0
■ PULSE LINE Main Sail and Jib



	STANDARD	PULSE LINE	%
Mast length	15.1 m 49'6"	15.9 m 52'1"	+ 5%
Square top mainsail	50 m ² 538 sq ft	53.5 m ² 576 sq ft	+ 7%
Self tacking jib	32 m ² 344 sq ft	35 m ² 377 sq ft	+ 9%
Upwind sail area	82 m ² 883 sq ft	88.5 m ² 936 sq ft	+ 7%
Code 0 [if option selected]	67 m ² 721 sq ft	75 m ² 807 sq ft	+ 12%
Sail Area / Displacement	4.27	4.43	+ 4%

2 - Square top mainsail and self-tacking jib in pro-radial

The boat comes in standard with a square top mainsail using top quality white Dacron[®], with horizontal cut.

With the PULSE LINE we offer a higher tech Dacron[®] with a different horizontal and vertical split of the fiber called Pro Radial, made by German company Dimension Polyant.

Together with a starcut assembly, it allows those larger sails to rise the stiffness of the sail, without the aging risks of laminar cloths.

Sails come in Grey color [in lieu of white Dacron[®] in standard].



Tri-radial cut
[non-contractual color]

PRORADIAL - Tri-radial cut. **[PULSE LINE]**

PRORADIAL fabric from Dimension POLYANT: warp-oriented woven polyester fiber ensuring a perfect adaptation of cut.

Tri-radial cut in accordance with the forces present in the sails.

Outstanding durability in shape and very good resistance against chafing

[Grey]



Horizontal cut
[non-contractual color]

Dacron[®] - Horizontal cut. [STANDARD]

Classic horizontal cut.

Dacron[®] sailcloth: weft-oriented woven polyester fiber, for a horizontal cut.

Good resistance & shape holding.

Excellent technical properties against chafing

[White]



3 - Code 0 Rig and Pole & Furler

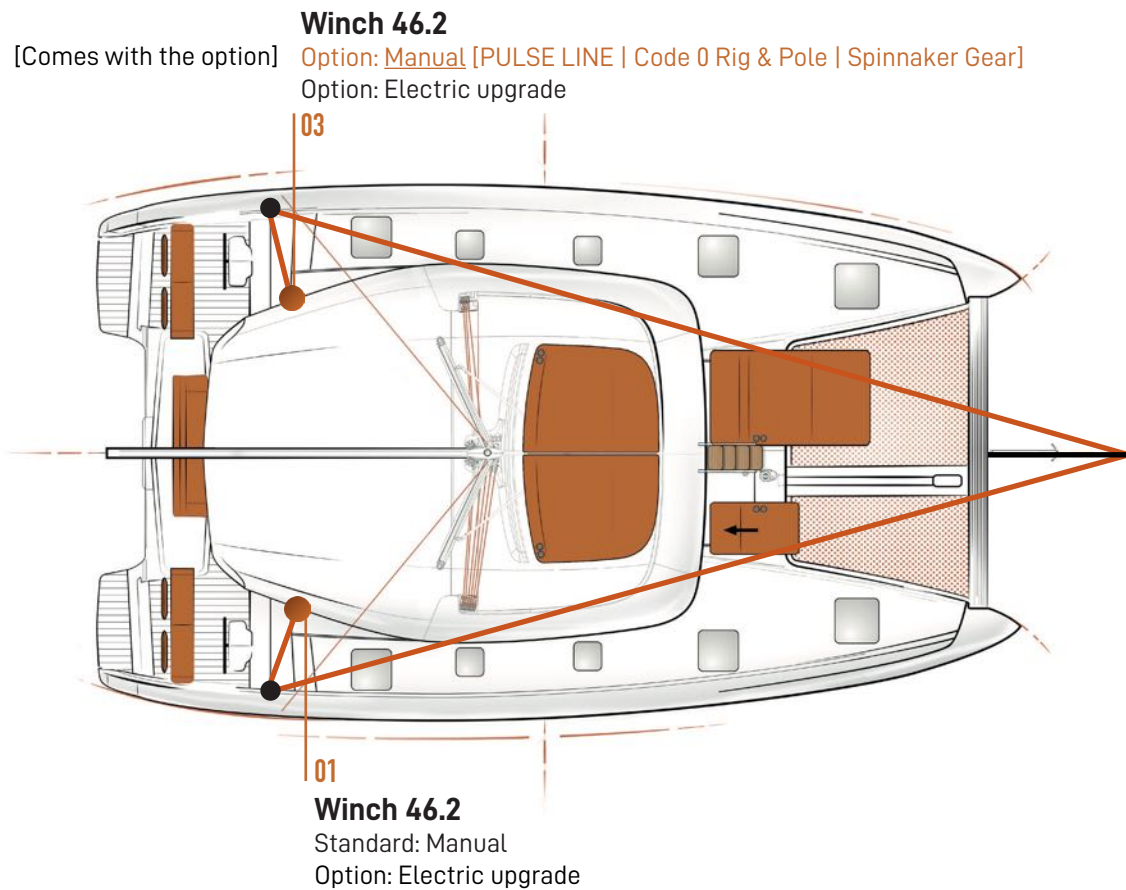

- 01** • Main sail halyard
- Jib sheet
- Jib halyard
- Reef 1
- Reef 2
- Topping lift
- Code 0 sheet [option]
- Spinnaker sheet [option]

- 03** • Code 0 halyard
- Code 0 sheet [option]
- Spinnaker halyard
- Spinnaker sheet [option]
- Reef 3 [PULSE LINE]

3 - Code 0 Rig and Pole & Furler

This option includes the following rigging:

A. Code 0 sheets rig

- Port Code 0 sheet
- Starboard Code 0 sheet
- 2 blocks with swivel – Element Block, Ø 80 Harken® [Port and Starboard]

B. Code 0 halyard rig

- Mast foot block
- Roof block Rutgerson® - [Port]
- Deck block Rutgerson® - [Port]
- Jammer on portside Spinlock® - [Port]
- Code 0 halyard

C. Manual winch on portside + ropes storage

D. Code 0 furler

E. Pole

[Details and pictures on the following pages]

Please note, this option not include the sails: Code 0 or Asymmetrical Spinnaker.

PULSE LINE

02

SAILING EXPERIENCE

RIGGING AND SAILS

3 - Code 0 Rig and Pole & Furler

A. Code 0 sheets rig

Block on starboard and port

Quantity: 2

Brand: HARKEN®

Model: 80 mm Aluminum Element Block — Swivel



[Reference no longer available]



PULSE LINE

3 - Code 0 Rig and Pole & Furler

B. Code 0 halyard rig

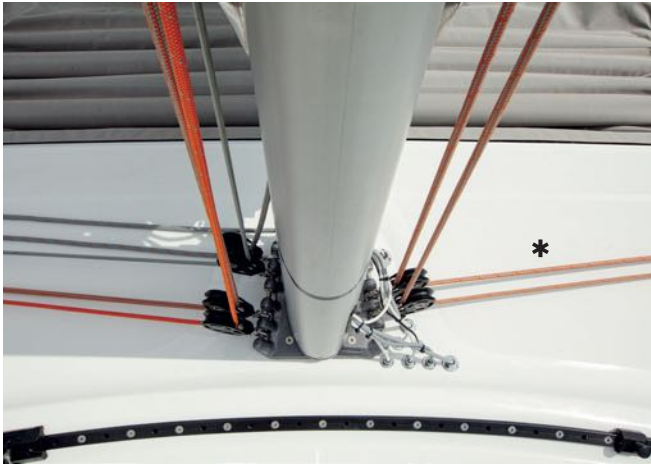

Mast foot block
Code 0 halyard

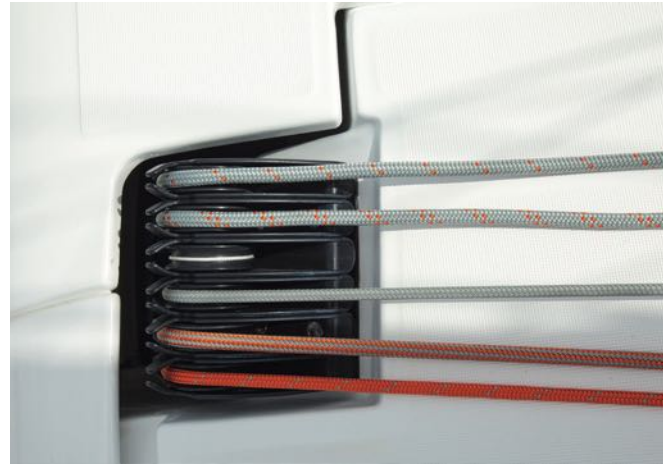

[Photo on starboard]

Roof foot block Rutgerson® - [Port]



Deck foot block Rutgerson® - [Port]
Jammer Spinlock® - [Port]

PULSE LINE

02 SAILING EXPERIENCE

RIGGING AND SAILS

3 - Code 0 Rig and Pole & Furler C. Manual winch on portside



Winch 46.2 STA HARKEN® comes with ropes storage.

[This photo includes the electrical upgrade option]

D. Code 0 furler Facnor® FX+4500 Cliq

E. Pole [1,500 mm | 4'11"]



5 - Barber Hauler

A flying barber hauler is a 4:1 hoist [same principle as the hoist of a dinghy catamaran] designed to be used with the mainsail sheet when the boats sails downwind, when the leeward mainsheet hoist let's go the boom to a point where the boom starts to move as much up as out: the leech of the main opens up and will very soon end up against the leeward rig shroud

To avoid this loss of power and this risk of damaging the sail cloth the flying barber hauler comes in: its top part is to connect to the top loop of the leeward mainsheet below the boom, the bottom is to connect on a padeye on the leeward side of the sheer line

Once in place, one trims the leech of the mainsail with both this device and the leeward mainsheet hoist. It can also be used as a boom preventer when sailing long downwind tacks.

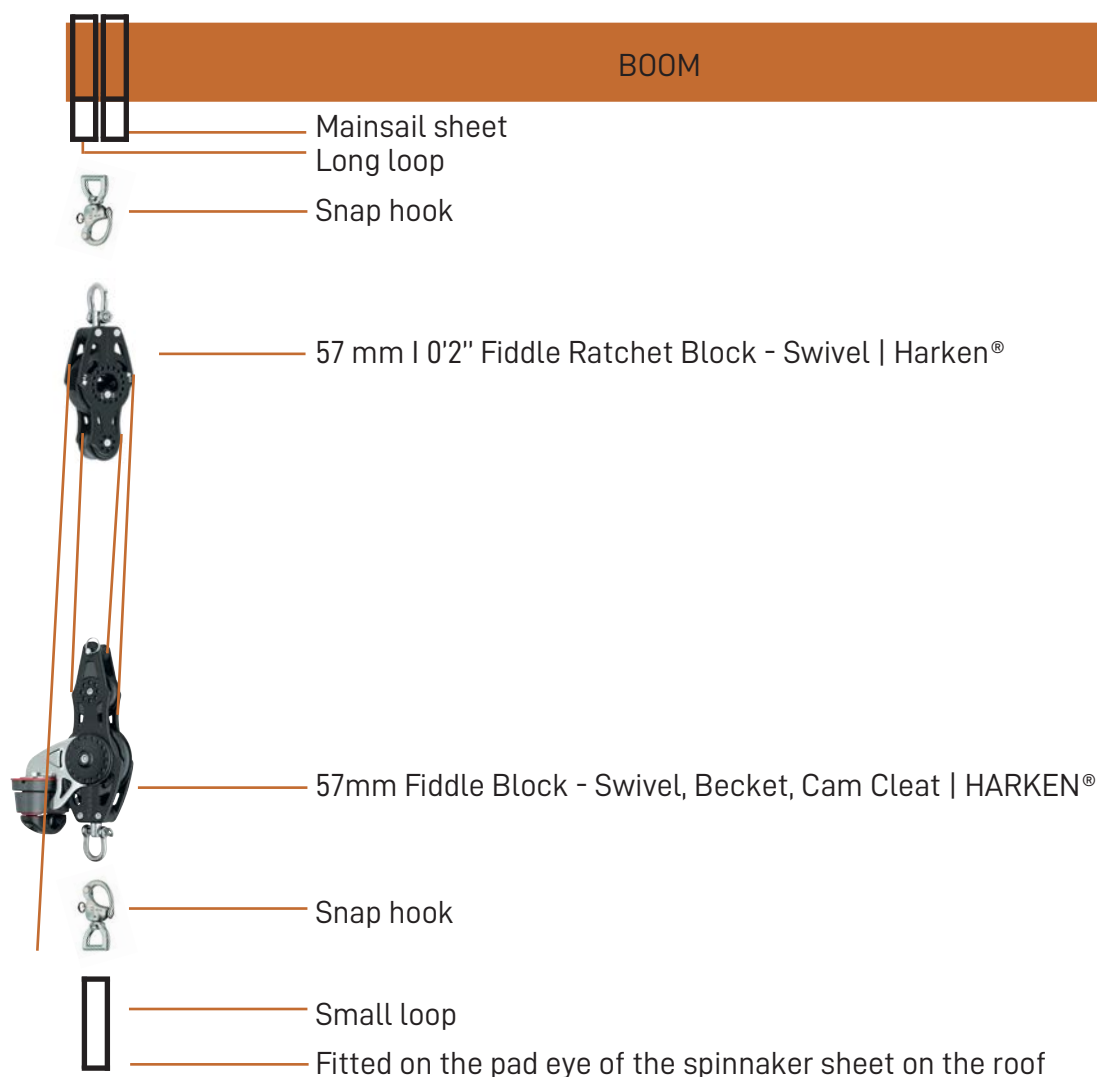

PULSE LINE

02

SAILING EXPERIENCE

RIGGING AND SAILS

5 - Barber Hauler



[Photos on EXCESS 11]

You can cleat it to the aft mooring cleats, on starboard if you are on a port tack, or on port if on a starboard tack. You will balance the tension on the flying barber-hauler and the leeward mainsheet to get a proper shape.

Do not forget to remove it before jibing or tacking!

6 - Textile lifelines

The textile lifelines replace the stainless steel standard lifelines.

Created and designed especially by LANCELIN, the textile lifelines brings a unique character and look to the outside of your boat.

Made from fiber for more efficiency, the customized **lifelines are fluorescent at night for safer night cruising.**

OPTION

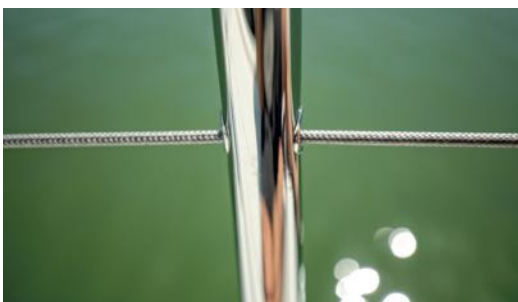
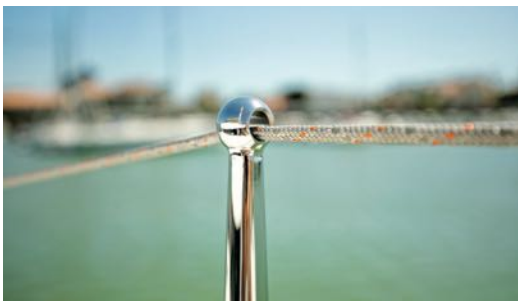

[reference no longer available]

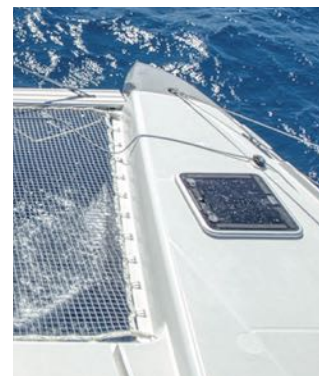

1

Brand: LANCELIN
Material: Fiber
Color: Grey & orange

2

The pad-eye is part of the option.
By selecting the textile lifelines
you get also a pad-eye.

7 - PULSE LINE steering wheels



OPTION



This option replaces the standard s/s steering wheels
Upgrade for both helm stations.

Brand: CARBONAUTICA
Material: Composite
Color: Orange

[Carbonautica - Steering wheel](#)

STANDARD



Material: Stainless steel & leather
Color: Grey

8 - PULSE LINE hull decoration

We've created a distinction between the standard line and the sportier PULSE LINE, while maintaining the same spirit. The inspiration came from the logo, a sporty and elegant wake, fluid and dynamic, taken up in an immoderate way in its PULSE LINE version. Isabelle's interest in typography made the process almost natural. The combined lines at the back of the hulls highlight the turn of the bilges in a marked and legible manner.



HULL DECORATION BY ISABELLE KELLER



"I have sailed a lot, racing, with a crew and I have shared the life of a professional sailor for a long time. I have experienced ocean racing and great adventures like the Transats and the Vendée Globe, from the inside. And then, on a simpler level, I have always wanted to live by the sea, overlooking the Atlantic Ocean."
Isabelle Keller, designer of the hull decoration.

EXTRA FOR STARBOARD ELECTRIC 40.2 WINCH



[Color upholstery no longer available]

Electric upgrade from manual winch [per standard] on **aft starboard**.

Brand: HARKEN
Model: 40.2 STEA

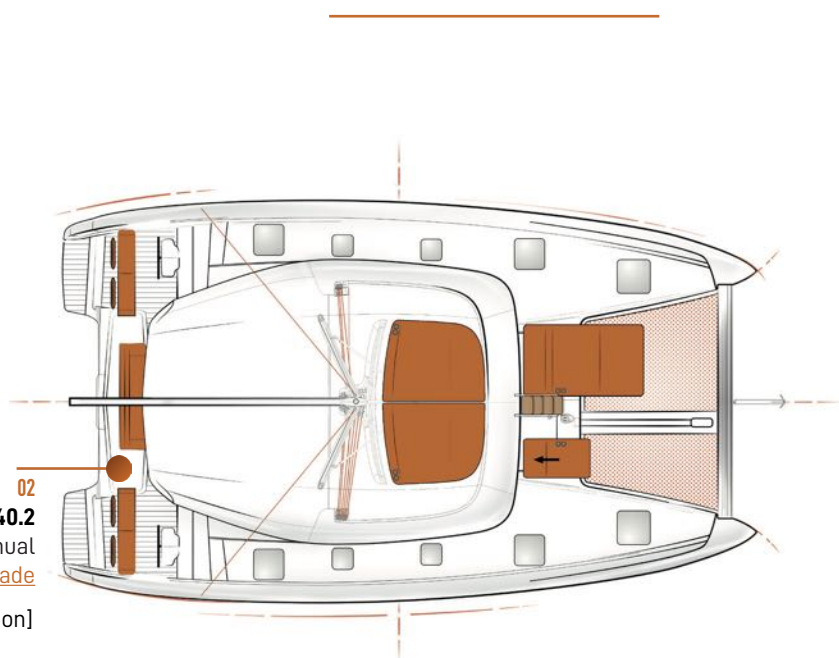

02 • Mainsheet traveler

02
Winch 40.2
Standard: Manual
Option: Electric upgrade
[Comes with the option]

EXTRA FOR STARBOARD ELECTRIC 46.2 WINCH



Electric upgrade from manual winch [per standard] on **starboard** helm station.

Brand: HARKEN
Model: 46.2 STEA

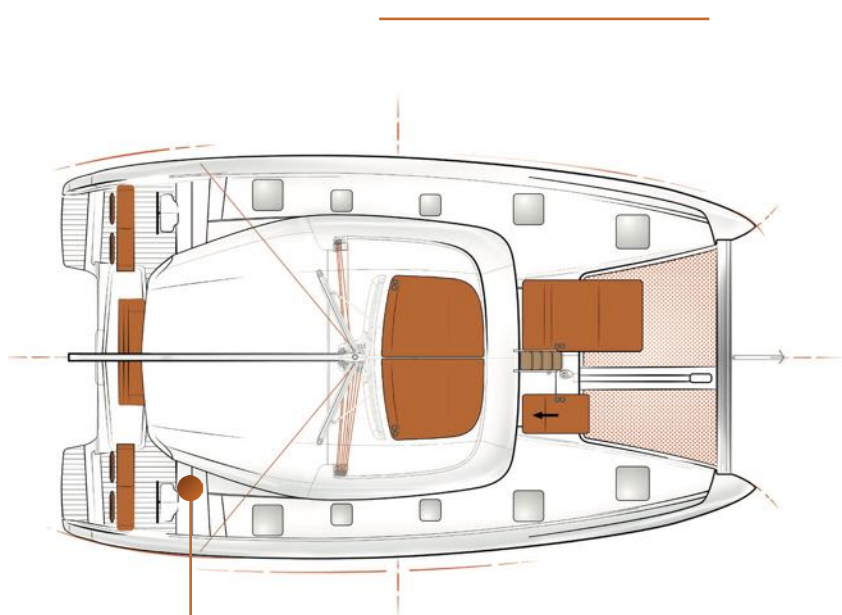

- 01**
- Main sail halyard
 - Jib sheet
 - Jib halyard
 - Reef 1
 - Reef 2
 - Topping lift
 - Code 0 sheet [option]
 - Spinnaker sheet [option]

01
Winch 46.2
Standard: Manual
Option: Electric upgrade [Comes with the option]

PORT ELECTRIC 46.2 WINCH

02 SAILING EXPERIENCE

RIGGING AND SAILS



Electric upgrade from manual winch on **port** helm station.

Brand: HARKEN
Model: 46.2 STEA

[Mandatory: PULSE LINE or Code 0 Rig & Pole or Spinnaker Gear options]

Winch 46.2

Option: Manual [PULSE LINE | Code 0 Rig & Pole | Spinnaker Gear]

Option: **Electric upgrade** [Comes with the option]

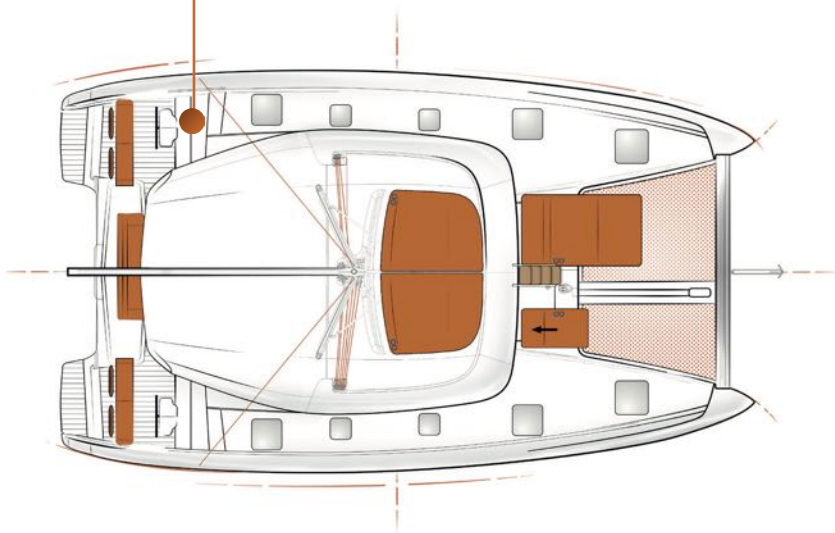

- 01**
- Code 0 halyard
 - Code 0 sheet [option]
 - Spinnaker halyard
 - Spinnaker sheet
 - Reef 3 [PULSE LINE]

CODE 0 RIG AND POLE & FURLER

STANDARD SAIL PLAN

Winch 46.2
[Comes with the option] Option: Manual [PULSE LINE | Code 0 Rig & Pole | Spinnaker Gear]
Option: Electric upgrade

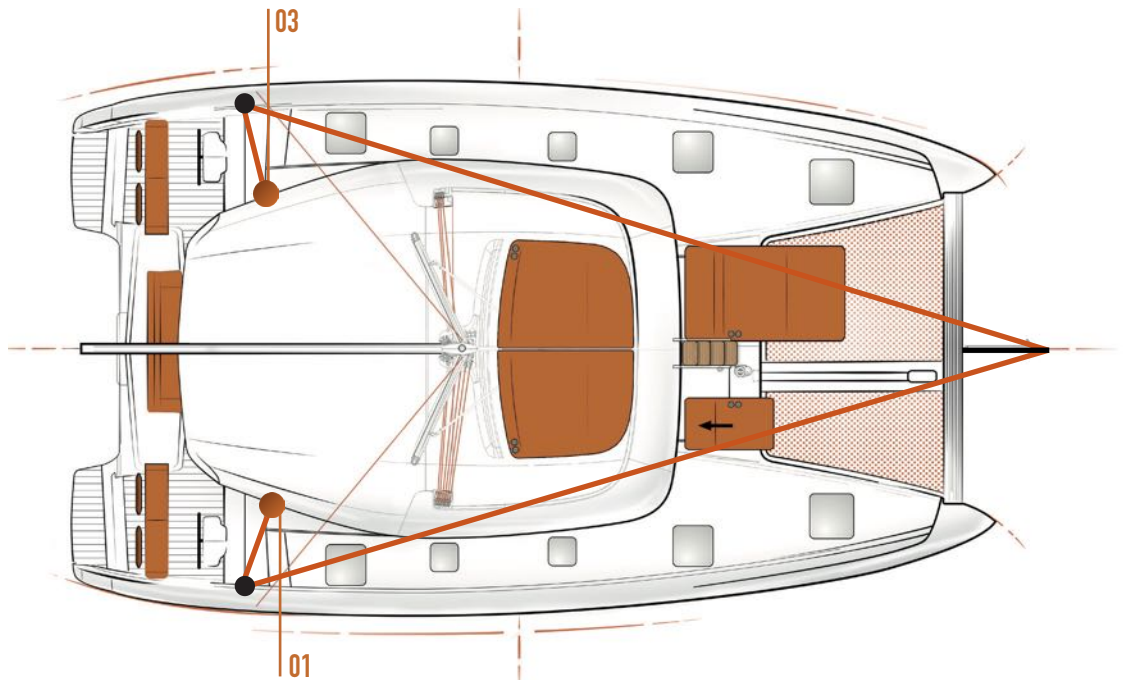

01
Winch 46.2
Standard: Manual
Option: Electric upgrade

- 01** • Main sail halyard
- Jib sheet
- Jib halyard
- Reef 1
- Reef 2
- Topping lift
- Code 0 sheet [option]
- Spinnaker sheet [option]

- 03** • Code 0 halyard
- Code 0 sheet [option]
- Spinnaker halyard
- Spinnaker sheet [option]
- Reef 3 [PULSE LINE]

CODE 0 RIG AND POLE & FURLER

STANDARD SAIL PLAN

This option includes the following rigging:

- A. Code 0 sheets rig**
 - Port Code 0 sheet
 - Starboard Code 0 sheet
 - 2 blocks with swivel – Element Block, Ø 80 HARKEN® [Port and Starboard]

- B. Code 0 halyard rig**
 - Mast foot block
 - Roof block Rutgerson® - [Port]
 - Deck block Rutgerson® - [Port]
 - Jammer on portside Spinlock® - [Port]
 - Code 0 halyard

- C. Manual winch on portside + ropes storage**

- D. Code 0 furler**

- E. Pole**

[Details and pictures on the following pages]

Please note, this option not include the sail.

CODE 0 RIG AND POLE & FURLER

A. Code 0 sheets rig

Block on starboard and port

Quantity: 2

Brand: HARKEN®

Model: 80 mm Aluminum Element Block — Swivel



[Reference no longer available]



CODE 0 RIG AND POLE & FURLER

B. Code 0 halyard rig

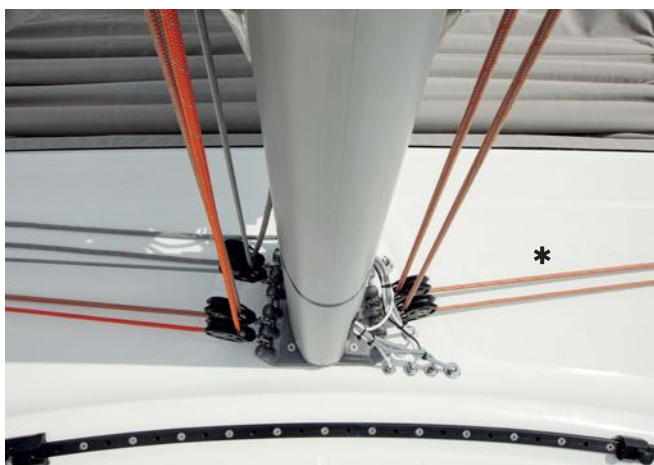

Mast foot block
Code 0 halyard

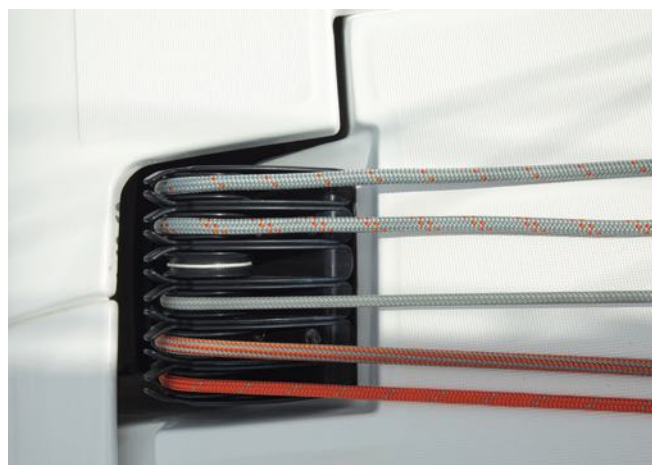

[Photo on starboard]

Roof foot block Rutgerson® - [Port]



Deck foot block Rutgerson® - [Port]
Jammer Spinlock® - [Port]

CODE 0 RIG AND POLE & FURLER

C. Manual winch on portside



Winch 46.2 STA HARKEN® comes with ropes storage.

[This photo includes the electrical upgrade option]

D. Code 0 furler

Facnor® FX+4500 Cliq

E. Pole

[825 mm | 2'8"]



ASYMMETRICAL SPINNAKER GEAR

STANDARD SAIL PLAN

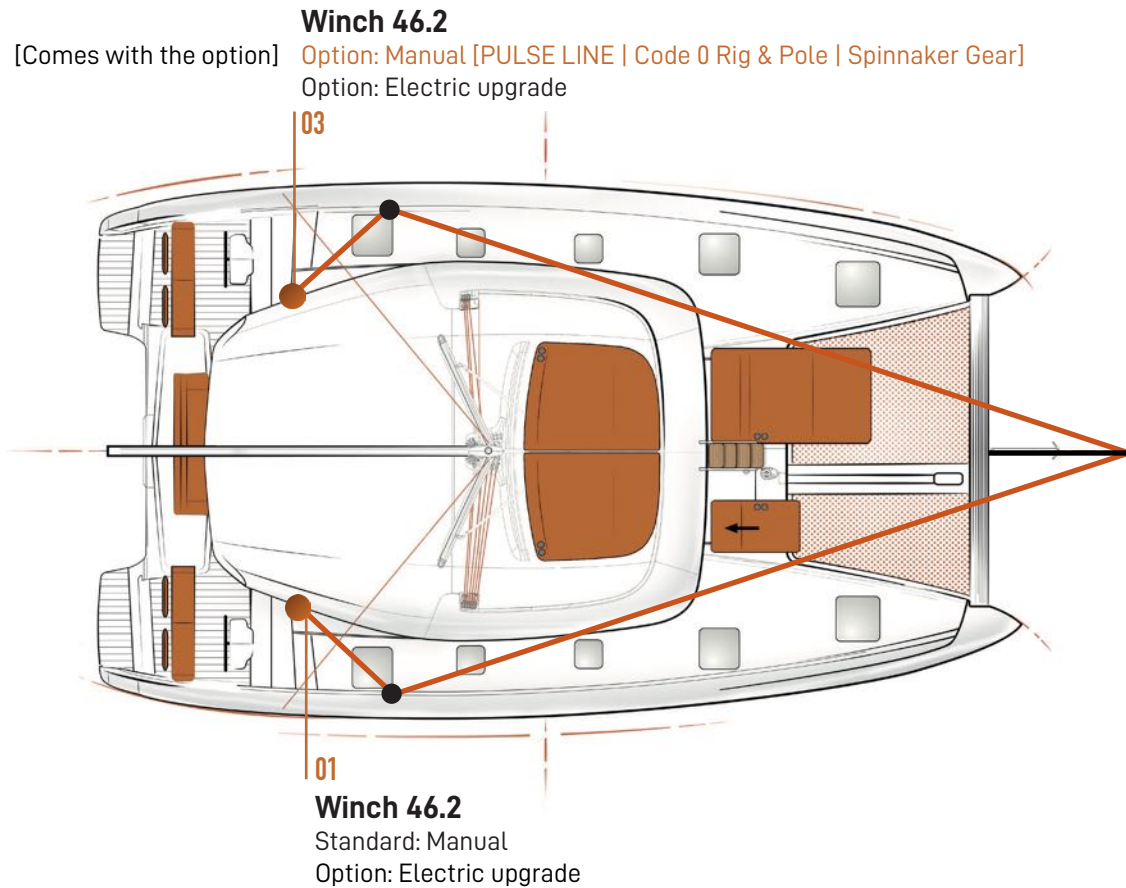

- 01**
- Main sail halyard
 - Jib sheet
 - Jib halyard
 - Reef 1
 - Reef 2
 - Topping lift
 - Code 0 sheet [option]
 - Spinnaker sheet [option]

- 03**
- Code 0 halyard
 - Code 0 sheet [option]
 - Spinnaker halyard
 - Spinnaker sheet [option]
 - Reef 3 [PULSE LINE]

ASYMMETRICAL SPINNAKER GEAR

STANDARD SAIL PLAN

This option includes the following rigging:

- A. Spinnaker sheets rig**
 - Port spinnaker sheet
 - Starboard spinnaker sheet
 - 2 blocks with swivel – Element Block, Ø 80 HARKEN® [Port and Starboard]

- B. Spinnaker halyard rig**
 - Mast foot block
 - Roof block Rutgerson® - [Port]
 - Deck block Rutgerson® - [Port]
 - Jammer on portside Spinlock® - [Port]
 - spinnaker halyard

- C. Manual winch on portside**

- D. Pole**

[Details and pictures on the following pages]

Please note, this option not include the sail.

ASYMMETRICAL SPINNAKER GEAR

A. Spinnaker sheets rig

Block on starboard and port

Quantity: 2
Brand: HARKEN®
Model: 80 mm | 0'3" Aluminum Element Block — Swivel



[Reference no longer available]



ASYMMETRICAL SPINNAKER GEAR

B. Spinnaker halyard rig

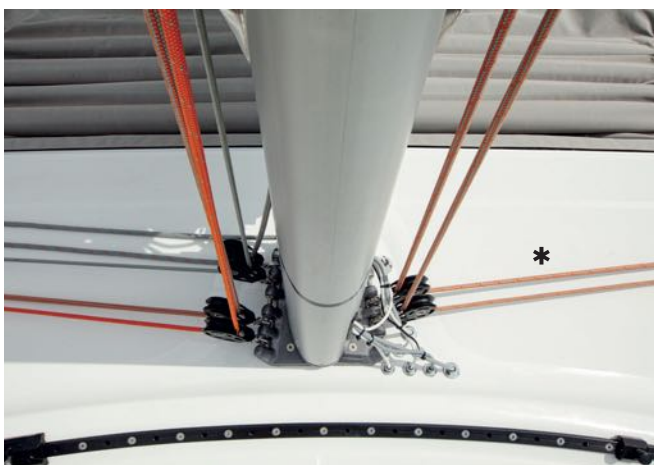

Mast foot block
Code 0 halyard

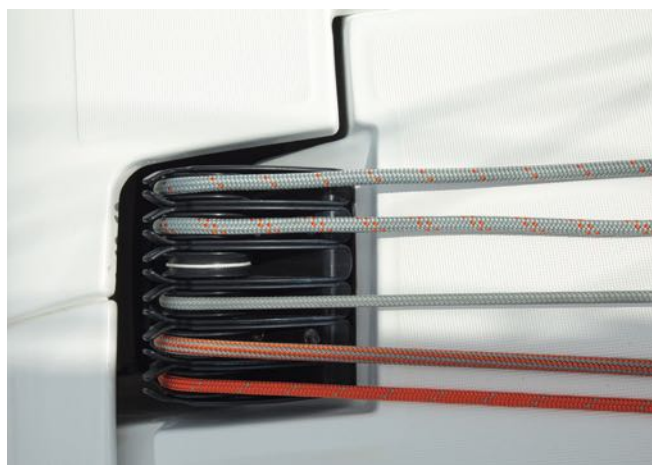

[Photo on starboard]

Roof foot block Rutgerson® - [Port]



Deck foot block Rutgerson® - [Port]
Jammer Spinlock® - [Port]

ASYMMETRICAL SPINNAKER GEAR

C. Manual winch on portside



Winch 46.2 STA HARKEN® comes with ropes storage.

[This photo includes the electrical upgrade option]

D. Pole

[1,500 mm | 4'11"]



CODE 0 IN MYLAR

02

SAILING EXPERIENCE

RIGGING AND SAILS

AVAILABLE FOR **STANDARD SAIL PLAN AND PULSE LINE SAIL PLAN**



Mylar is a plastic sheet made from the resin Polyethylene Terephthalate. It is laminated into sailcloth and provides high tensile strength, dimensional stability, and transparency

This option includes the sail only

CODE 0 sail surface

Standard: 67 m² | 721 sq ft

PULSE LINE: 75 m² | 807 sq



ASYMMETRICAL SPINNAKER WITH SOCKET

02 SAILING EXPERIENCE

RIGGING AND SAILS

AVAILABLE FOR **STANDARD SAIL PLAN AND PULSE LINE SAIL PLAN**



[Non-contractual sail : exclusive design for launch]

This option includes :

- 1 sail: asymmetrical spinnaker
- 2 sheets
- 1 socket

SPINNAKER sail surface

Standard: 115 m² | 1,237 sq ft

PULSE LINE: 135 m² | 1,453 sq ft



[Incidence Sails - Customisation](#)

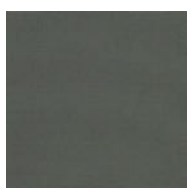

Color: Charcoal grey
Sunbrella® SUNTT 5049 152

RAYMARINE ELECTRONIC UPGRADE PACK

[SAIL AWAY Pack mandatory]

A. AFT HELM STATIONS

This option includes :



[Steering wheel no longer available.
Helm station evolution starting from 12#25]

STARBOARD [Main helm station]:

- Upgrade: **AXIOM 9" touch screen** multifunction display in lieu of i70s as per SAIL AWAY Pack
- As per SAIL AWAY Pack: **p70s Autopilot** control heads with color display
- **Support and USB tablet** charger



PORT:

[Additional GRP console]

- **i70s Multifunction instrument display** with color display high definition and user interface Lighthouse III
- As per SAIL AWAY Pack: **p70s Autopilot** control heads with color display
- **Support and USB tablet** charger

RAYMARINE ELECTRONIC UPGRADE PACK

A. AFT HELM STATIONS

SAIL AWAY

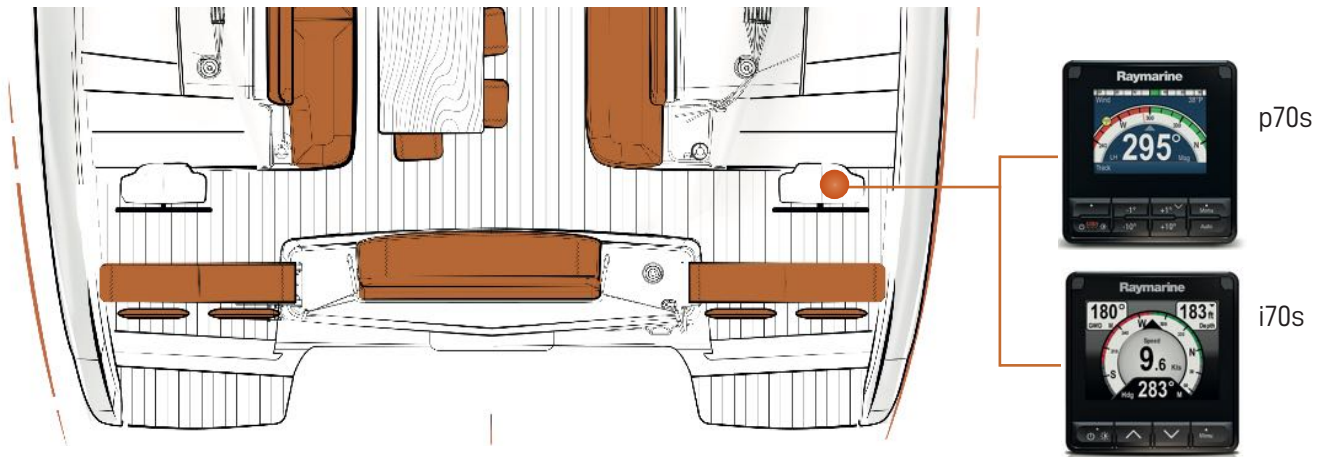

RAYMARINE ELECTRONIC UPGRADE PACK

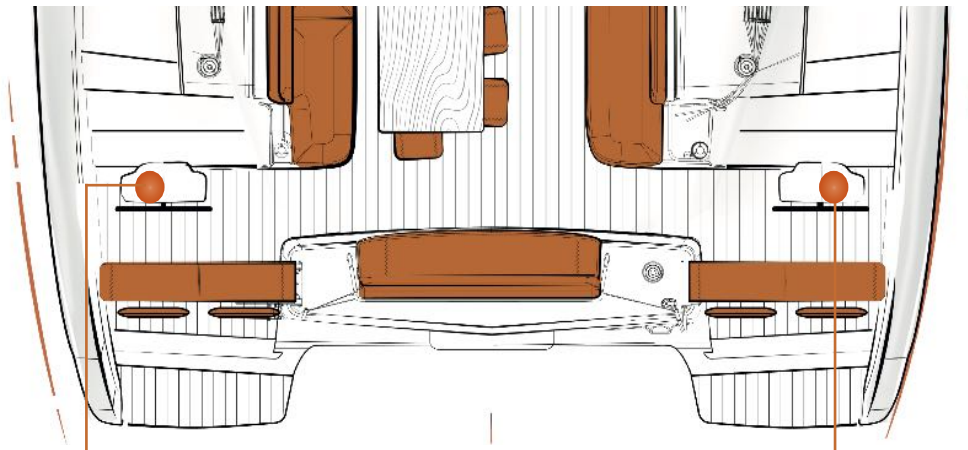



p70s
Model: E70331



i70s
Model: E70330



Brand: ROKK
Model: Mini universal tablet kit



Axiom 9"
Model: E70366



p70s
Model: E70331



Brand: ROKK
Model: Mini universal tablet kit

RAYMARINE ELECTRONIC UPGRADE PACK

B. SALON



This option includes :

- **Support and USB tablet** charger

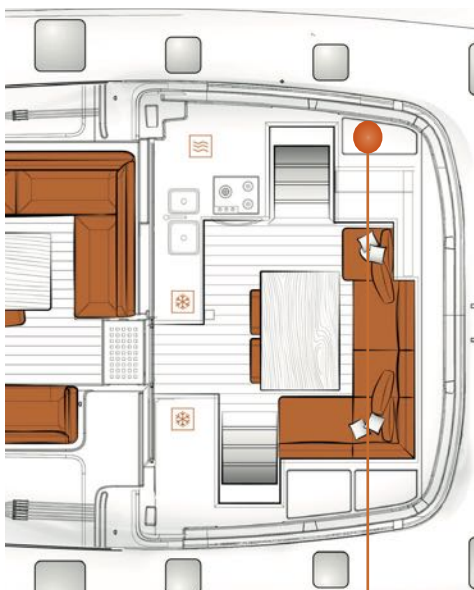

Brand: ROKK
Model: Mini universal
tablet kit

UPGRADE FOR AXIOM 12" DISPLAY

[Raymarine pack upgrade mandatory]



Raymarine



[Helm station evolution starting from 12#25]

This option includes :

STARBOARD [Main helm station]:

Upgrade: **AXIOM 12" touch screen** multifonction display wifi in lieu of AXIOM 9" display

[RAYMARINE Electronics upgrade Mandatory]

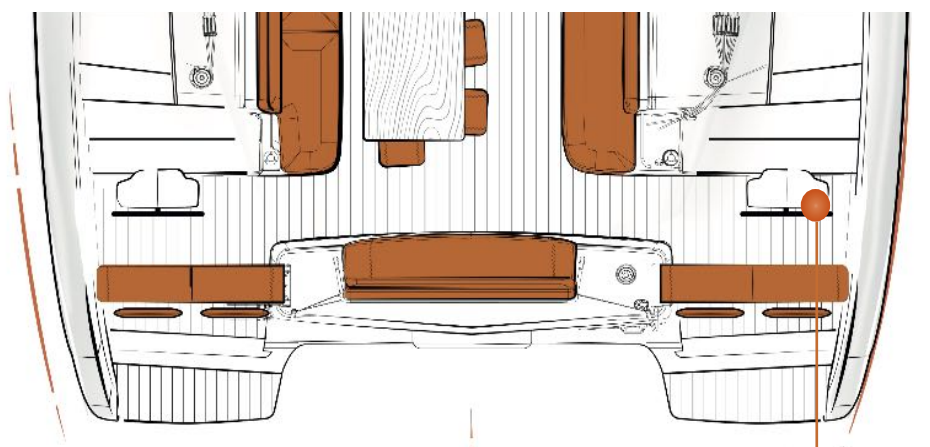



Axiom 12"
Model : E70368



AIS 700 RAYMARINE TRANSCEIVER WITH ANTENNA COUPLING

Raymarine®



[AIS700]

AIS700 Class B Transceiver with integrated antenna splitter [Model: E70476]

Key features:

- Full transmit and receive AIS
- Latest SO-TDMA networking
- Built-in antenna splitter
- NMEA2000, NMEA0183, PC and SeaTalking compatible
- Software or hardware switchable Silent Mode

RAYMARINE RADAR 4G QUANTUM

02 SAILING EXPERIENCE

ELECTRONICS



[QUANTUM 2 CHIRP RADAR 24 MN]

Raymarine Quantum 2 Radar with Doppler collision avoidance technology [Model: E70498]
The option includes stainless steel protection.

Key features:

- Doppler moving target display allows for superior situational awareness at-a-glance
- Fully automatic MARPA target tracking, along with manual MARPA mode
- Adjustable TrueTrails target history shows the motion history of moving contacts
- CHIRP Pulse Compression detects contacts as close as 18-feet for zero-visibility navigation
- 24-mile range for early detection of traffic, navigation aids, landfall and weather
- Immediate awareness – Quantum starts up and is ready to go in seconds
- Superior interference rejection eliminates noise from other radars
- Low power consumption for extended battery life under sail

RAYMARINE REALVISION SOUNDER



Brand: RAYMARINE
Model: **RV-200** Bronze All-In-One Through Hull Transducer [A80465]

Easily identifies structures and locate fish with the life-like clarity of RealVision 3D™ sonar

Maximum depth:
3D: 91.5 m | 300'2"
DownVision: 183 m | 600'4"
Port & Starboard: 91.5 m | 300'2"
Conical: 274 m | 898'11"

Beam width [L|H]:
3D: 180° | Down: 60° | Conical: 25°



[RAYMARINE RV-200]

LOCATION ON BOARD

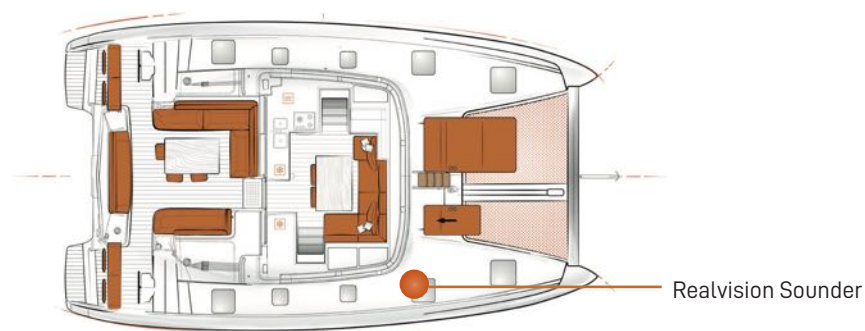

RAYMARINE PILOTE SMART CONTROLLER

02 SAILING EXPERIENCE

ELECTRONICS



The Raymarine SeaTalk autopilot comes with the wireless SmartController [Model: E15023]

Key Features:

- User-definable pages
- Keylock security
- Backlit buttons
- Display local and system alarms
- Wireless instrument repeater
- Wireless full-function autopilot controller

Raymarine

LOCATION ON BOARD

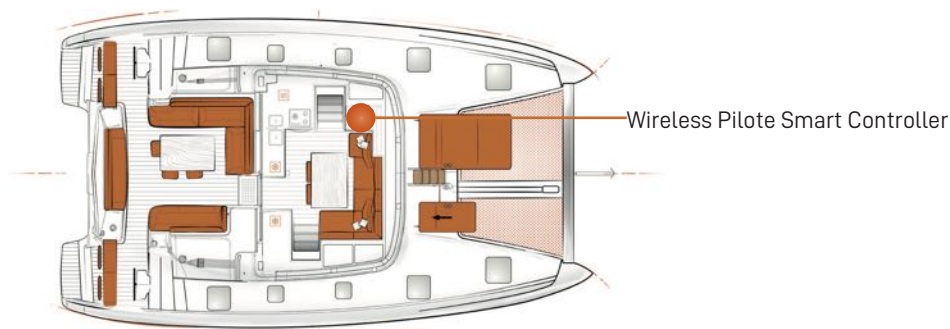

VHF RAYMARINE SINGLE HANDSET



VHF Ray90 ASN combined with active speaker [Raymarine model: A80543]. and wireless station [Raymarine model: A80540]. Model: E70492

Key Features:

- Black box, multi-station capable VHF radio
- Built-in loudhailer and fog signal generator
- Optional external GPS
- Simple NMEA2000 and NMEA0183 Networking

Raymarine

LOCATION ON BOARD

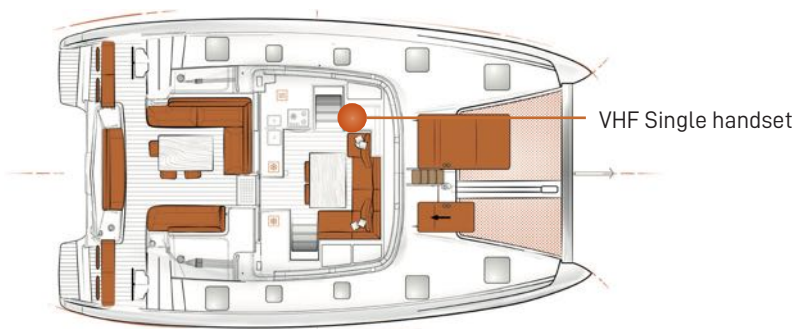

2ND WIRELESS HANDSET FOR VHF RAYMARINE



[Helm station evolution starting from 12#25]

Wireless hub carries both data and audio to and from your wireless handset stations
[VHF Ray90 ASN]

Key Features:

- Waterproof construction
- Oversized LCD and rubberized keypads
- Built-in lithium ion rechargeable battery
- Inductive charging technology
- Wireless base station pairs to active speaker
- Handset features smart locator alarm activate alarm from hub



LOCATION ON BOARD

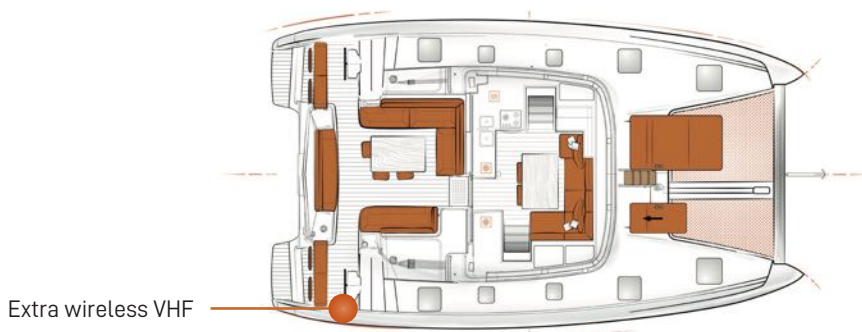

03

OUTSIDE EXPERIENCE

Sliding top on roof

Extra for aft transoms lateral access

Aft cockpit + transoms in natural teak with grey caulking

Extra for large teak table + cover in aft cockpit

Windlass remote control at helm station with chain counter

Pulpits with composite seats and forward lifelines

Textile lifelines

Boarding ladder

Cockpit fridge 40L [12V]

Folding carbon gangplank

Outboard engine bracket

Pair of stainless steel davits

PULSE LINE steering wheels

PULSE LINE hull decoration

Additional storage in the cockpit

Textile storage under roof

Textile storage on forward net

OUTSIDE UPHOLSTERIES

Enclosures with windows for aft cockpit

Biminis on port and starboard helm stations with windows

Forward deck sun awning [canopee]

Additional double helm seat on portside

Aft cockpit cushions

Aft cockpit sunbathing

Forward cockpit cushions with adjustable backrests

Roof sunbathing

SLIDING TOP ON ROOF

03 OUTSIDE EXPERIENCE



Sliding top opened



Sliding top closed

SLIDING TOP ON ROOF

03 OUTSIDE EXPERIENCE



Manual sliding roof. Replaces the standard GRP roof.

! Warning !

Do not walk on the sliding roof area, it is not meant to support the weight of a person

Dimensions:

2,700 L x 2,550 W mm | 8'9" x 8'4"



Color: Cadet Grey
Sunbrella® SUNTT 5530 152

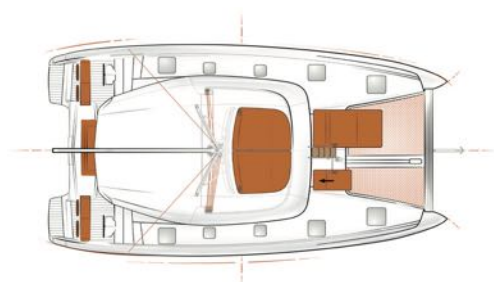

[Standard]

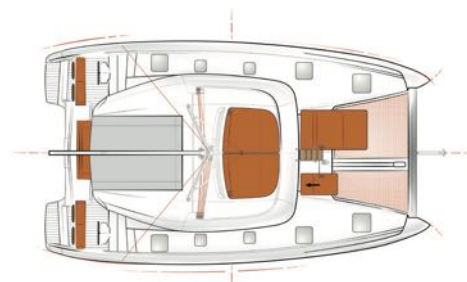

[Option]

EXTRA FOR AFT TRANSOMS LATERAL ACCESS

EXCESS 12 larger version [+365 mm | 1'2"] with greek specifications.

Standard LOA: 11.74 m | 38'6" [without davits, pole, etc.]

Standard LOA + greek specifications: 12.1m | 39'9"

Maximum LOA : 13.06 m | 42'10" [with solar panels, spinnaker pole, etc.]

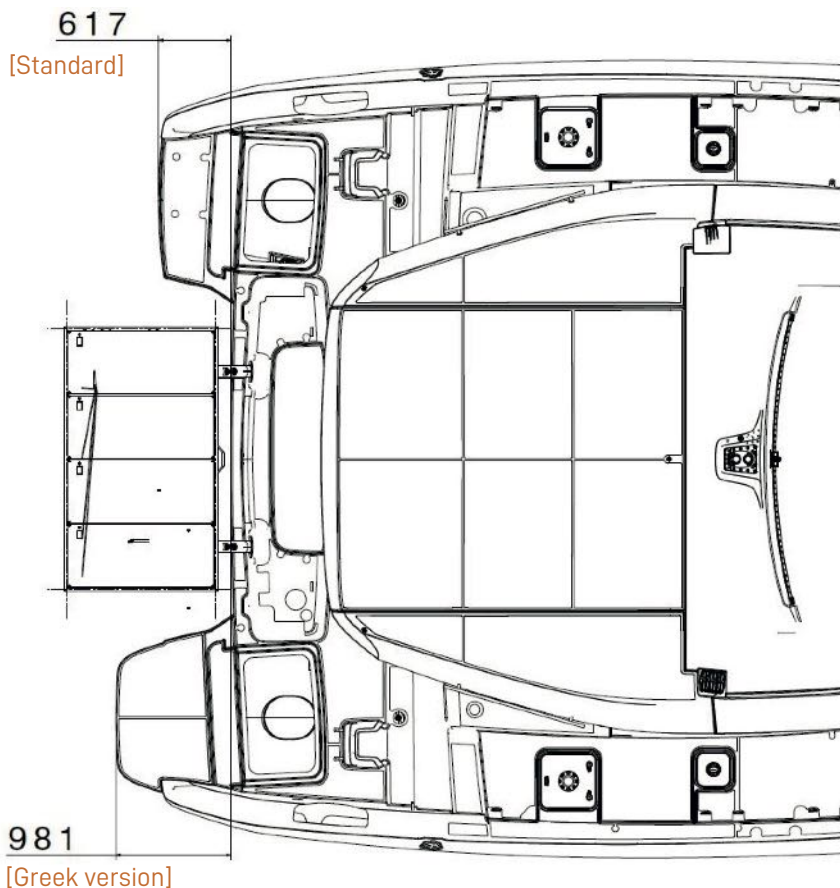

[Not compatible with aft cockpit and transoms in natural teak option]

AFT COCKPIT + TRANSOMS IN NATURAL TEAK



[Option]

Natural teak with grey caulking

Covers the aft cockpit floor and both transoms.

Standard: white GRP



LOCATION ON BOARD

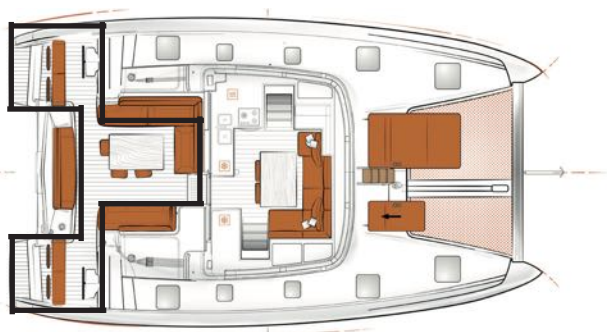

EXTRA FOR LARGE TEAK TABLE + COVER

03 OUTSIDE EXPERIENCE



Large natural teak table [opt]:
1,600 x 840 mm | 5'2" x 2'9"

Composite cockpit table [std]:
1,400 x 820 mm | 4'7" x 2'8"



The option includes a cover:



Color: Cadet Grey
Sunbrella® SUNTT 5530 152



[Standard GRP cockpit table]

WINDLASS REMOTE CONTROL AT HELM STATION WITH CHAIN COUNTER



The option includes:

- Windlass remote control from starboard helm station
- A chain counter

The option completes standard remote control in front storage compartment.

LOCATION ON BOARD

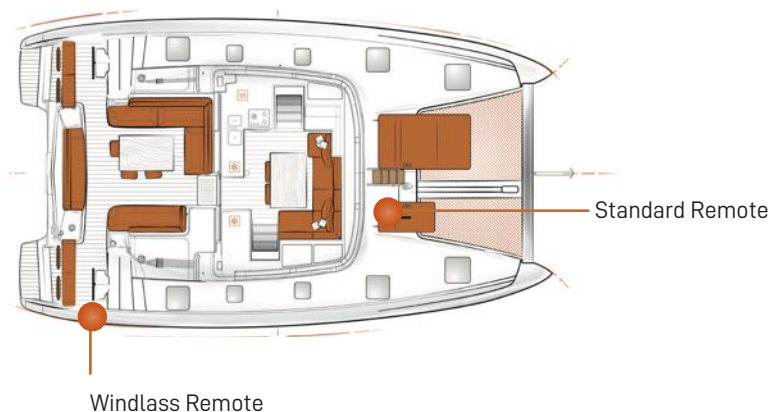

PULPITS WITH COMPOSITE SEATS AND FORWARD LIFELINES



[Photo onboard EXCESS 11]

This option includes 2 forward pulpits [port and starboard] with composite seats.

The option is available with **stainless steel** or **textile** lifelines.



[Standard]

LOCATION ON BOARD

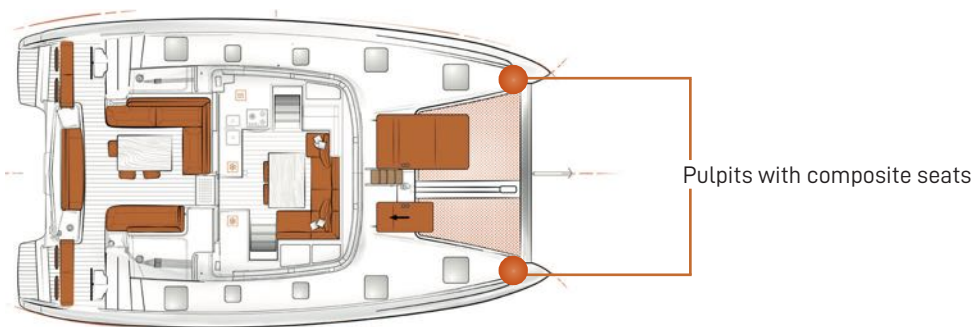

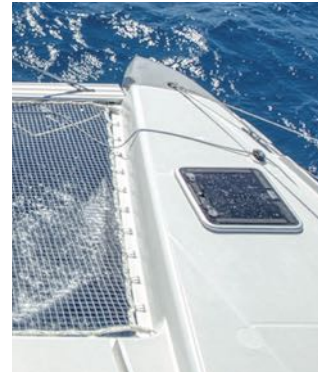

[reference no longer available]

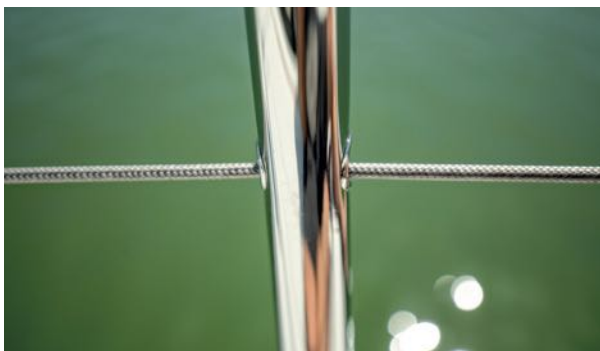

1

Textile lifelines

2

The pad-eye is part of the option. By selecting the textile lifelines you get also a pad-eye.

Textile lifelines are available as part of the **PULSE LINE Pack** or as an option.

The customized lifelines are fluorescent at night for safer night cruising.

Brand: LANCELIN

Material: Fiber

Color: Orange & Grey

[Standard: Stainless steel lifelines & pad-eye]

BOARDING LADDER

03 OUTSIDE EXPERIENCE



Stainless steel removable boarding ladder.

Quantity: 1

Two possible locations: either on port or starboard

[Opening lifelines in SAIL AWAY Pack]



COCKPIT FRIDGE 40L

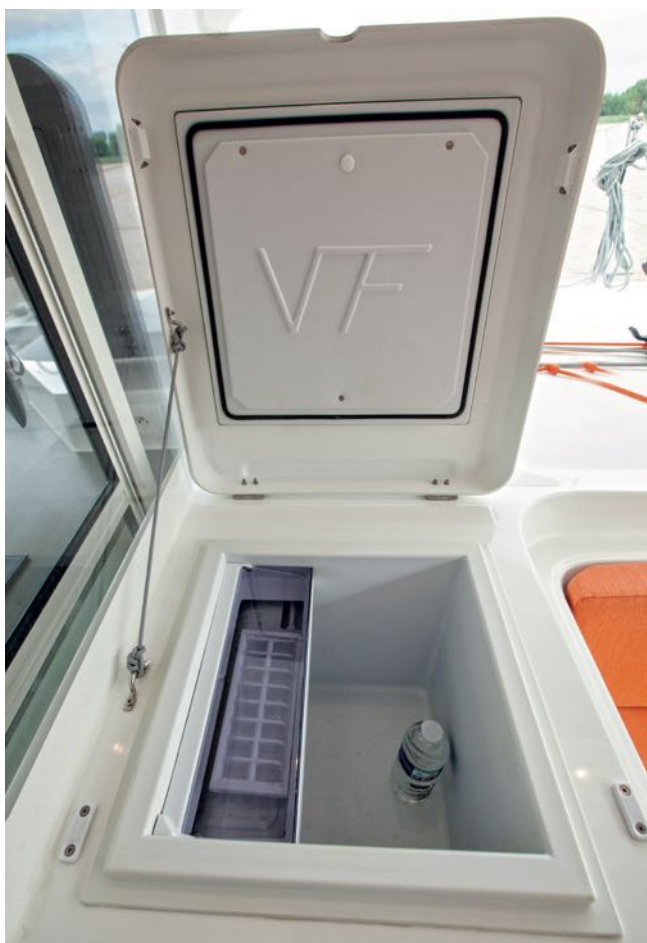

40 L | 11 US gal refrigerator located in the aft cockpit [12 V].

[Not compatible with additional storage in the cockpit]

Brand: Vitrifrigo®
Model: C40L

[Vitrifrigo - 12V cockpit Fridge](#)

LOCATION ON BOARD

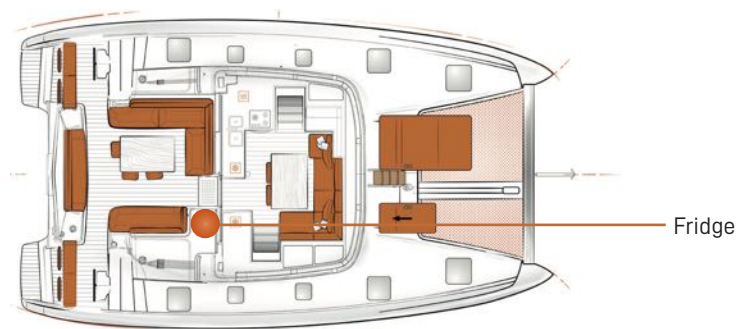

FOLDING CARBON GANGPLANK

03

OUTSIDE EXPERIENCE



The option includes :

- Gangplank
- Cover
- 2 Sockets

Gangplank dimensions

Open: 2,600 x 350 mm | 8'6" x 1'1"

Closed: 1,300 x 350 mm | 4'3" x 1'1"

OUTBOARD ENGINE BRACKET



Stainless steel bracket on the aft [starboard]

Maximum power: 10HP engine

LOCATION ON BOARD

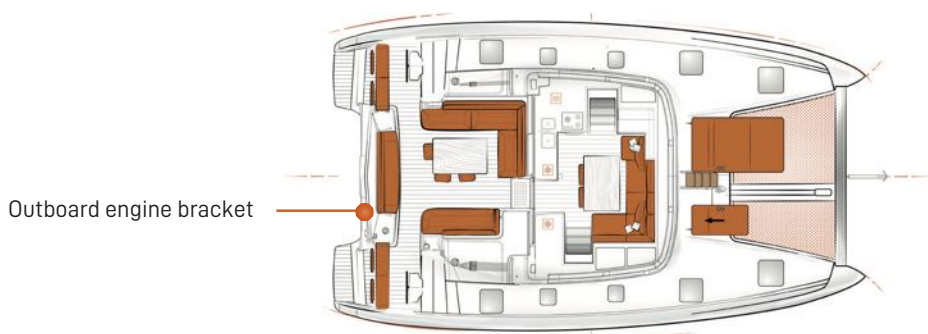

PAIR OF STAINLESS STEEL DAVITS

03

OUTSIDE EXPERIENCE



Load:
Max 150 kg | 331 lbs

Dinghy:
Max Length 2,90 m | 9'6"



Upgrade for stainless steel davits option: foam protections.

LOCATION ON BOARD

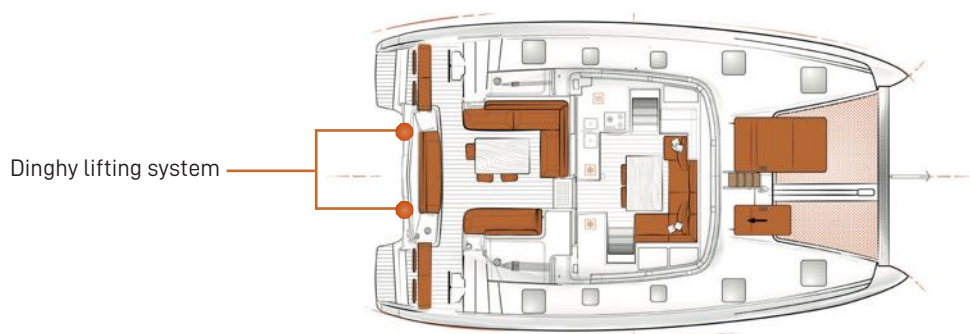

PULSE LINE STEERING WHEELS

03

OUTSIDE EXPERIENCE



OPTION



This option replaces the standard s/s steering wheels
Upgrade for both helm stations.

Brand: CARBONAUTICA

Material: Composite

Color: Orange

[Carbonautica - Steering wheel](#)

STANDARD



Material: Stainless steel & leather

Color: Grey

PULSE LINE HULL DECORATION

03 OUTSIDE EXPERIENCE

We've created a distinction between the standard line and the sportier PULSE LINE, while maintaining the same spirit. The inspiration came from the logo, a sporty and elegant wake, fluid and dynamic, taken up in an immoderate way in its PULSE LINE version. Isabelle's interest in typography made the process almost natural. The combined lines at the back of the hulls highlight the turn of the bilges in a marked and legible manner.



HULL DECORATION BY ISABELLE KELLER



"I have sailed a lot, racing, with a crew and I have shared the life of a professional sailor for a long time. I have experienced ocean racing and great adventures like the Transats and the Vendée Globe, from the inside. And then, on a simpler level, I have always wanted to live by the sea, overlooking the Atlantic Ocean."
Isabelle Keller, designer of the hull decoration.

ADDITIONAL STORAGE IN THE COCKPIT



The option includes **2 additional storage units** with front and top access in the aft cockpit.

[not compatible with cockpit fridge 40L]



TEXTILE STORAGE UNDER ROOF

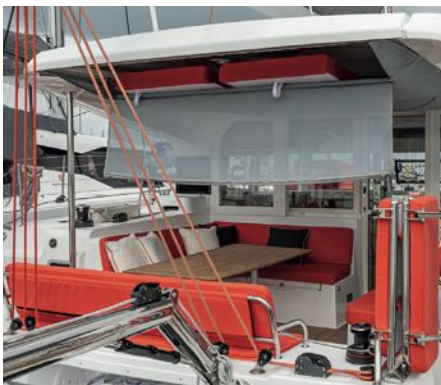

XXL textile **storage under standard roof.**

Double access to store upholstery, mattress, enclosures, paddle board, etc.

[not compatible with sliding roof option]

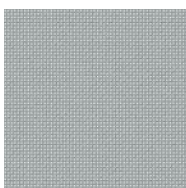

Color: Grey

Fabrics : Ferrari Batyline ISO 7407 - 5003 ACIER

TEXTILE STORAGE ON FORWARD NET



[Photo onboard EXCESS 11]

Canvas storage bag on forward trampoline for any storage.

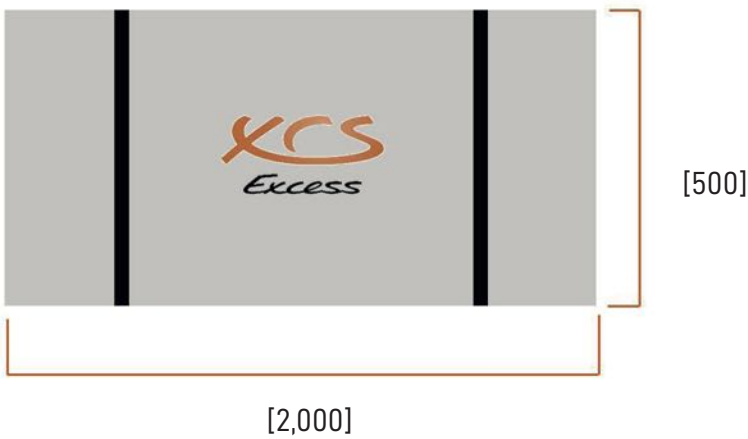

Color: Grey [Light Charcoal]
Fabrics : Weather Max 80

ENCLOSURES WITH WINDOWS FOR AFT COCKPIT



Enclosures made in fabric with PVC transparent windows.

The option includes 1 large aft enclosure with 2 doors on each side.

Lateral dedicated storage in the roof with fabric cover.



Color: Cadet Grey
Sunbrella® SUNTT 5530 152

BIMINIS ON HELM STATIONS WITH WINDOWS



This option includes:

- **2 biminis** with enclosures and windshield [portside and starboard]
- Stainless steel structure with canvas top roof
- Additional enclosures with windows on side and aft and windshield
- Dedicated storage bag for each bimini



[Photo onboard EXCESS 11]



Color: Cadet Grey
Sunbrella® SUNTT 5530 152

FORWARD DECK SUN AWNING [CANOPEE]

03

OUTSIDE EXPERIENCE

UPHOLSTERIES



The option includes:

- Sun Awning
- Storage bag [58L - 10KG]
- 1 Halyard
- Spinlock XTS0814/1B on mast



Color: Grey [Light Charcoal]

Fabrics : Weather Max 80

You can manouver the sun awning from the mast foot.

Fitting must be attached to an halyard to move up and down the sun awning. The sun awning must be attached on cleats and shrouds, never on stanchions or lifelines.

ADDITIONAL DOUBLE HELM SEAT ON PORTSIDE



Additional double foldable helm seat on **portside**

The option includes the cover.

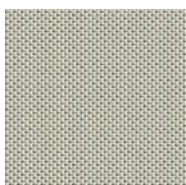

Color: Grey
FERRARI® Batyline Lounge Quartz
7720FR-50932



Color: Orange
SUNBRELLA® Mezzo Tigerlily
MEZZ 10222 140

AFT COCKPIT CUSHIONS

03

OUTSIDE EXPERIENCE

UPHOLSTERIES



The option includes cushions - and upholstery color - for all aft cockpit settees :

- L-shaped sofa on portside
- Starboard bench
- Aft beam settee

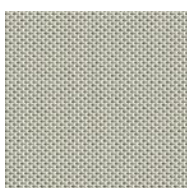

Color: Grey
FERRARI® Batyline Lounge Quartz
7720FR-50932



Color: Orange
SUNBRELLA® Mezzo Tigerlily
MEZZ 10222 140

AFT COCKPIT CUSHIONS

03

OUTSIDE EXPERIENCE

UPHOLSTERIES

PORT SOFA

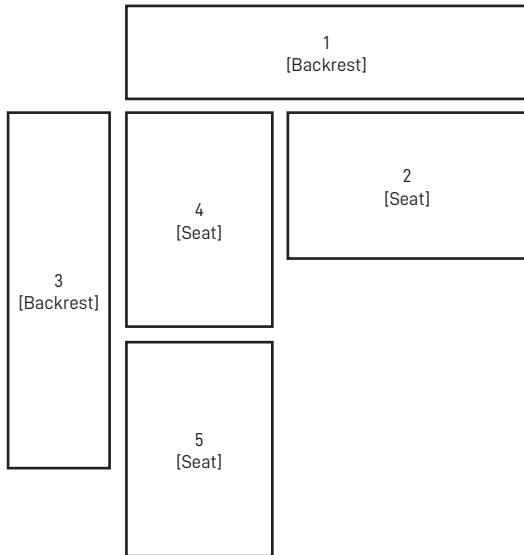

STARBOARD

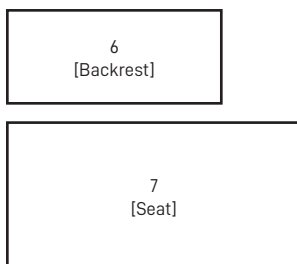

AFT BEAM

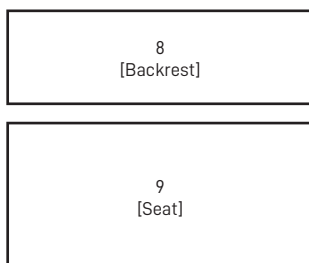

AFT COCKPIT SUNBATHING



Aft bench and modular table transforming into a **wide sunpad area**.

Dimensions : 2100 x 1360 mm | 6'11" x 4'6"

The option includes:

- 2 table legs
- 1 mattress

[Teak table option mandatory]



Color: Grey
FERRARI® Batyline Lounge Quartz
7720FR-50932



Color: Orange
SUNBRELLA® Mezzo Tigerlily
MEZZ 10222 140

FORWARD COCKPIT CUSHIONS WITH ADJUSTABLE BACKRESTS



[Cup holders missing] [New standard roof ladder]

The option includes:

- 2 sunbathing mattresses with **adjustable backrests**
- 1 central independent mattress with integrated **cup holders**.

Matresses feature an integrated cover in the back for easy protection.

Dimensions [portside]: 1,850 H x 915 W mm | 6'0" x 3'0"

Dimensions [starboard]: 1,850 H x 770 W mm | 6'0" x 2'5"



Color: Grey
FERRARI® Batyline Lounge Quartz
7720FR-50932



Color: Orange
SUNBRELLA® Mezzo Tigerlily
MEZZ 10222 140

ROOF SUNBATHING

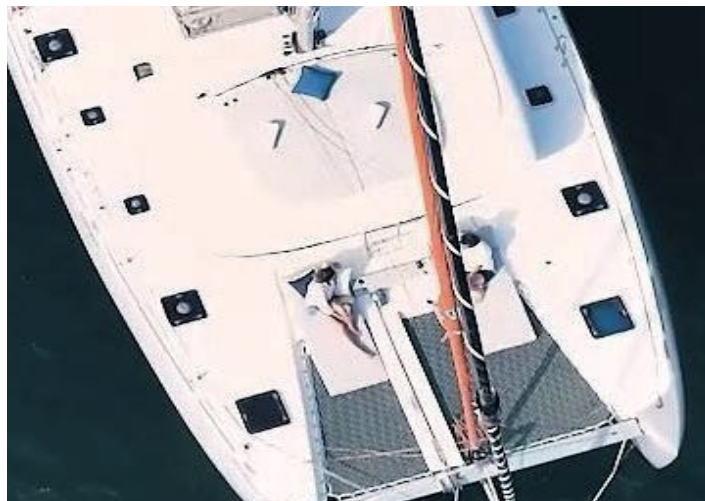

[New standard roof ladder]

The option includes **2 sunbathing mattresses**, located in the roof.
Top of the sunbath integrates cup holders.
Mattresses feature an integrated cover in the back for easy protection.

Dimensions : 1,850 H x 2,350 W mm | 6'0" x 7'8"

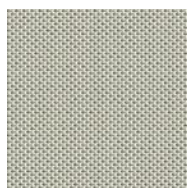

Color: Grey
FERRARI® Batyline Lounge Quartz
7720FR-50932



Color: Orange
SUNBRELLA® Mezzo Tigerlily
MEZZ 10222 140

04

TECHNICAL EQUIPMENT

ENGINES

Engines 2x 45HP [Yanmar 4JH45]

Electric engines throttles at helm stations

Pair of 3-blades folding propellers

ELECTRICAL CIRCUIT

PANDA genset 10kVA [230V/50Hz] + Cocoon

Inverter 2kVA [12V/230V]

Solar panels on davits

WATER CIRCUIT

Additional fresh water tank 300L

Watermaker 60L/H [12V]

Sea water pump

Fresh water dock inlet

Deck wash pump [Sea water | Fresh water]

Sea water electrical toilets

ENGINES 2X 45HP [YANMAR 4JH45]

04 TECHNICAL EQUIPMENT ENGINES

The option includes the engine replacement from standard [Yanmar 3YM30 | 2 x 29HP] to **Yanmar 4JH45 SD| 2 x 45HP.**



[Yanmar 4JH45 SD]

The optional Yanmar 4JH45 SD| 2 x 45HP comes with fixed propellers 18x14 per standard.

[45 HD fixed propellers 18x14]

MOTEUR / engine	YANMAR	45 cv	3000 trs/mn
	EMBASE/sail drive	2,49/1	
	HELICES / propeller	3-fix 18x14	
CONDITIONS DES ESSAIS	Vent / wind:	5 knots	
Atmospheric conditions	Mer / sea	0,0-0,5m	
POIDS DU BATEAU / weight		11 100 kg	
Carburant / fuel (1l = 0,83 kg)	400	336 kg	800
Eau / water (litres)	300	300 kg	1010
Equipage / crew	4	300 kg	1203
Sécurité et mouillage / safety equipment		150 kg	1410
Divers / others		200 kg	1618
		12 386 kg	1820
			2008
			2230
			2423
			2610
			2813
			3053

Régime Moteur en Trs/mn Engine rpm	Vitesse moyenne : nœuds Average speed : knots	Consommation moyenne / moteur Fuel consumption / engine	
		L / H	US Gal / H
800	3,35	0,60	0,16
1010	4,05	0,75	0,20
1203	4,75	0,95	0,25
1410	5,70	1,30	0,34
1618	6,05	1,70	0,45
1820	6,75	2,40	0,63
2008	7,25	2,95	0,78
2230	7,60	3,85	1,02
2423	7,80	4,95	1,31
2610	8,05	5,70	1,51
2813	8,25	7,50	1,98
3053	8,50	9,55	2,52

Informations non contractuelles.
These informations are not contractual.

La vitesse moyenne est relevée au GPS / GPS speed
La consommation en fuel est donnée en litre pour 1 moteur / Litre fuel consumption for one engine.

ELECTRIC ENGINES THROTTLES AT HELM STATIONS

04 TECHNICAL EQUIPMENT ENGINES

Directly fitted on both helm stations [port and starboard], electric engines throttles replaces the standard mechanical throttle [1 on starboard main helm station].

This option includes :



On STARBOARD [Main steering station]

- Engine throttles upgrade : electric in lieu of mechanical in standard
- Control panel upgrade : A10 Start/Stop panel [one per engine] & YD42 display [one for both engines] in lieu of B25 panel in standard [one per engine]



On PORTSIDE

[Additional GRP support on the side]

- Additional A10 Start/Stop panel [one per engine] & YD42 display [one for both engines]
- Secondary electric engine throttles

ELECTRIC ENGINES THROTTLES AT HELM STATIONS

04 TECHNICAL EQUIPMENT ENGINES

STANDARD

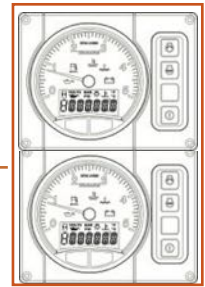
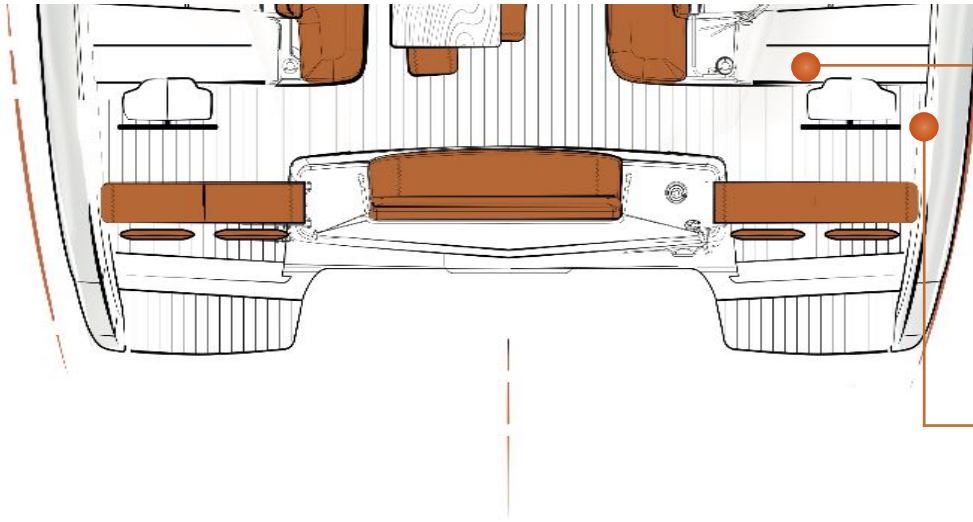

B25 panel



Mecanical throttles
Ultraflex® B324

OPTION

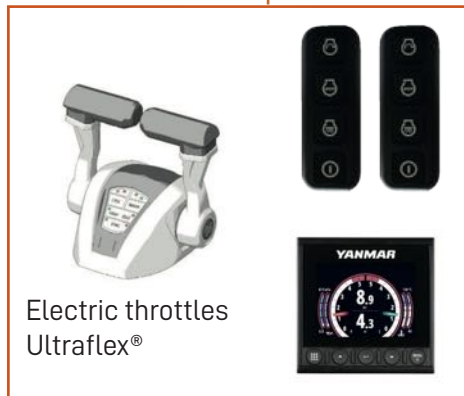
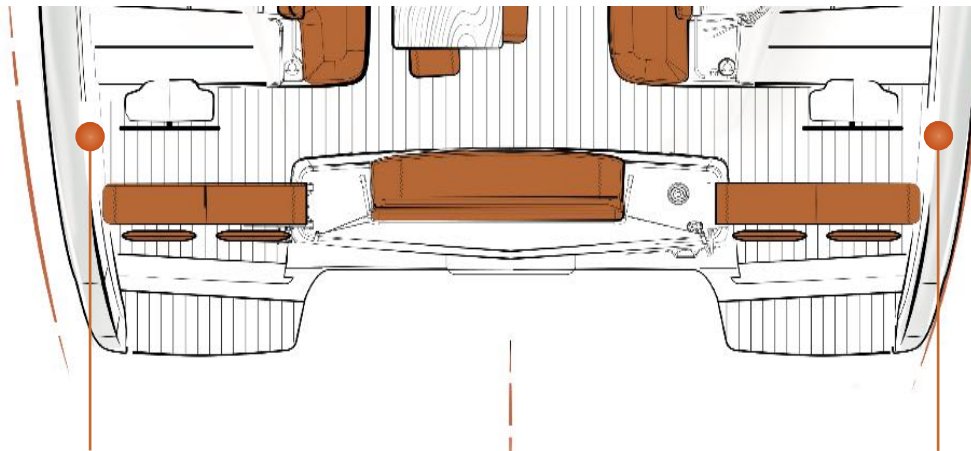

A10 start/stop panel A10 start/stop panel

YD42 display

YD42 display



Electric throttles
Ultraflex®

PAIR OF 3-BLADES FOLDING PROPELLERS

Replaces 29 HP fixed propellers 16x13 [standard].

Brand : FENWICK
Model : Flex-o-fold



[29 HP engine option: folding propellers 16x12]

MOTEUR / engine	YANMAR	3YM30AE	29 cv	3200 trs/mn
	Inverseur	SD25	2,64/1	
HELICES / propeller	3-blade folding 16x12 (option)			
CONDITIONS DES ESSAIS	Vent / wind:	5-10knots		
Atmospheric conditions	Mer / sea	0,50-1,00m		
POIDS DU BATEAU / weight		10 700 kg		
Carburant / fuel (l1 = 0,83 kg)	100	85 kg		
Eau / water (litres)		kg		
Equipage / crew	2	150 kg		
Sécurité et mouillage / safety equipment		210 kg		
Divers / others		kg		
		11 145 kg		

Régime Moteur en Trs/mn Engine rpm	Vitesse moyenne : nœuds Average speed : knots		Consommation moyenne / moteur Fuel consumption / engine	
			L / H	US Gal / H
821	2,30	1,40	0,37	
1000	2,95	2,00	0,53	
1200	3,45	2,20	0,58	
1400	4,05	2,30	0,61	
1600	4,80	2,70	0,71	
1800	5,25	2,90	0,77	
2000	5,75	3,20	0,85	
2200	6,20	3,60	0,95	
2400	6,65	4,10	1,08	
2600	7,05	4,60	1,22	
2800	7,40	5,40	1,43	
3000	7,60	6,70	1,77	
3308	7,90	10,60	2,80	

Informations non contractuelles.

These informations are not contractual.

La vitesse moyenne est relevée au GPS / GPS speed

La consommation en fuel est donnée en litre pour 1 moteur / Litre fuel consumption for one engine.

[45 HP engine option: folding propellers 17x14]

MOTEUR / engine	YANMAR	4JH45	45 cv	3000 trs/mn
	Inverseur	SD60TS	2,5/1	
HELICES / propeller	3-blade folding 17x14 (option)			
CONDITIONS DES ESSAIS	Vent / wind:	10knots		
Atmospheric conditions	Mer / sea	1,00-1,50m		
POIDS DU BATEAU / weight		12 580 kg		
Carburant / fuel (l1 = 0,83 kg)	400	340 kg		
Eau / water (litres)		600 kg		
Equipage / crew	2	150 kg		
Sécurité et mouillage / safety equipment		210 kg		
Divers / others		kg		
		13 880 kg		

Régime Moteur en Trs/mn Engine rpm	Vitesse moyenne : nœuds Average speed : knots		Consommation moyenne / moteur Fuel consumption / engine	
			L / H	US Gal / H
800	2,30	1,20	0,32	
1000	3,60	1,50	0,40	
1200	4,00	1,90	0,50	
1400	4,90	2,60	0,69	
1600	5,50	3,40	0,90	
1800	6,05	4,80	1,27	
2000	6,35	5,90	1,56	
2200	7,00	7,70	2,03	
2400	7,65	9,90	2,62	
2600	7,85	11,40	3,01	
2800	8,00	15,00	3,96	
3000	8,40	19,10	5,05	
3125	8,90		0,00	

Informations non contractuelles.

These informations are not contractual.

La vitesse moyenne est relevée au GPS / GPS speed

La consommation en fuel est donnée en litre pour 1 moteur / Litre fuel consumption for one engine.

PANDA GENSET 10KVA

04

TECHNICAL EQUIPMENT

ELECTRICAL CIRCUIT



[Forward port technical compartment]

Comes in original shield which minimizes noise and vibrations.

Brand: FISCHER PANDA
Model: Panda 10 000i PMS

Dedicated 12V 50A battery.
Works with both fuel tanks.
Tug in aft port cabin to select port tank or starboard tank.

Control panel in forward port compartment next to the genset and in technical compartment in port companionway.

230V 50HZ: 10kVA
120V 60HZ: 10kVA



[Forward port technical compartment]



[Technical compartment port companion way]

LOCATION ON BOARD

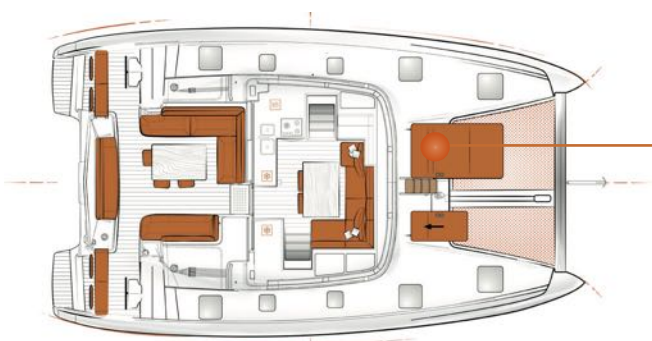

Genset
[Not compatible with additional fresh water tank]

INVERTER 2KVA



Brand: MASTERVOLT
Model: AC Master 12|2000 [Ref: 28512000]
Power: 2,000 VA

Available in 230V and 120V.

Automatic selection when shore power [SAIL AWAY Pack compulsory] is detected from the system
Power switches automatically from the inverter to the shore power.

LOCATION ON BOARD

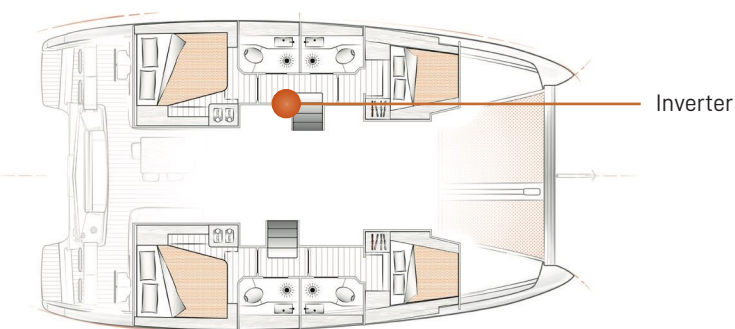

SOLAR PANELS ON DAVITS

04 TECHNICAL EQUIPMENT

ELECTRICAL CIRCUIT

The option includes 4 panels of 120W each **[Total: 460W]**



Brand: Solara
 Quantity: 4
 Rated output: 120W
 Panel dimension: [L x B] : 1,250 x 543 | 4'1" x 1'9"
 Weight [per unit]: 4.4 kg
 Cell dimension: 125 x 125 mm | 0'4" x 0'4"
 Cell technology: mono crystalline with backcontact

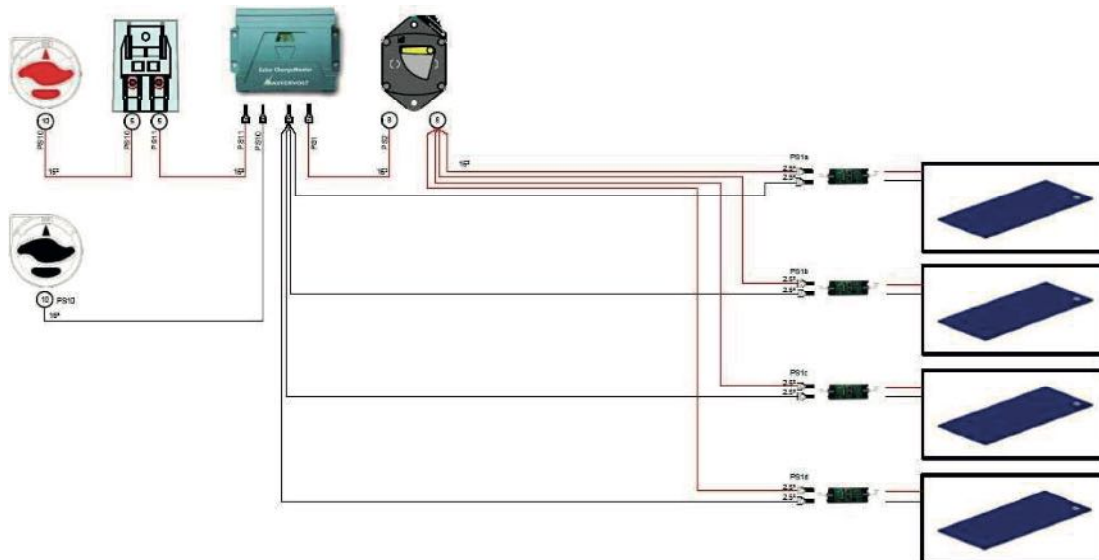

120V / 60 HZ NORTH AMERICAN SPECIFICATIONS

This option includes all the changes on standard electrical equipments from 230V/50Hz to 120V/60Hz [Technical drawing on following page]

Main changes detailed underneath:

1 | Shore Power | 120V - 60Hz
32A shore power [SAIL AWAY Pack] replaced by 50A shore power

2 | Sockets:
[Cabin and technical compartment]

Cabin

Standard socket

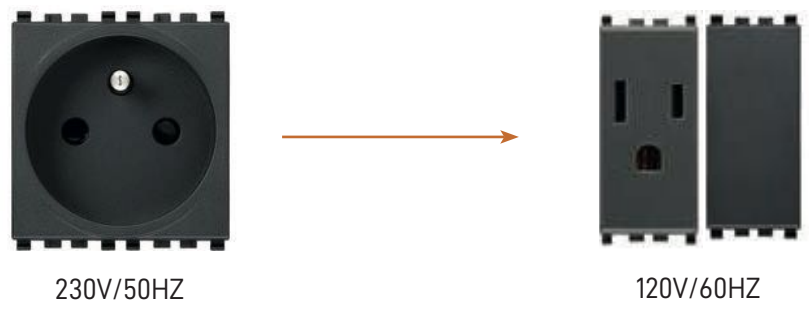

Socket with USB

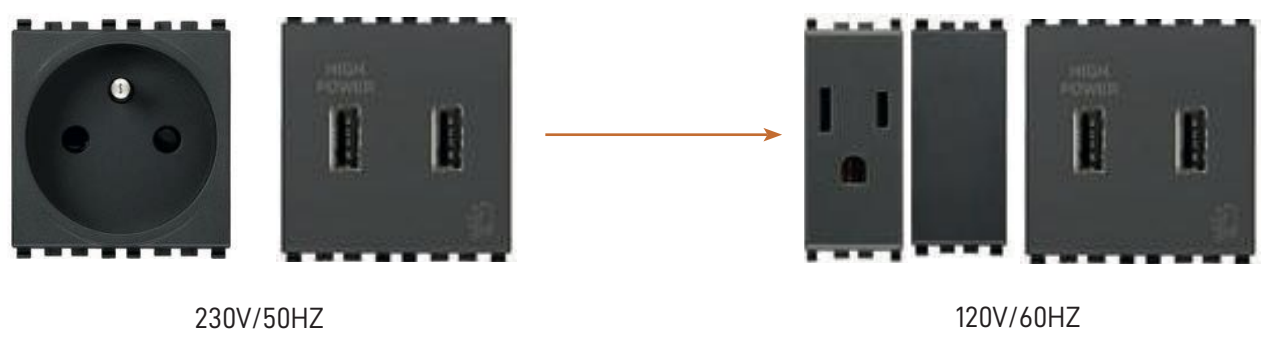

3 | Gas circuit:
Gas solenoid valve with indicator light and electrical switch

120V / 60 HZ NORTH AMERICAN SPECIFICATIONS

04 TECHNICAL EQUIPMENT ELECTRICAL CIRCUIT

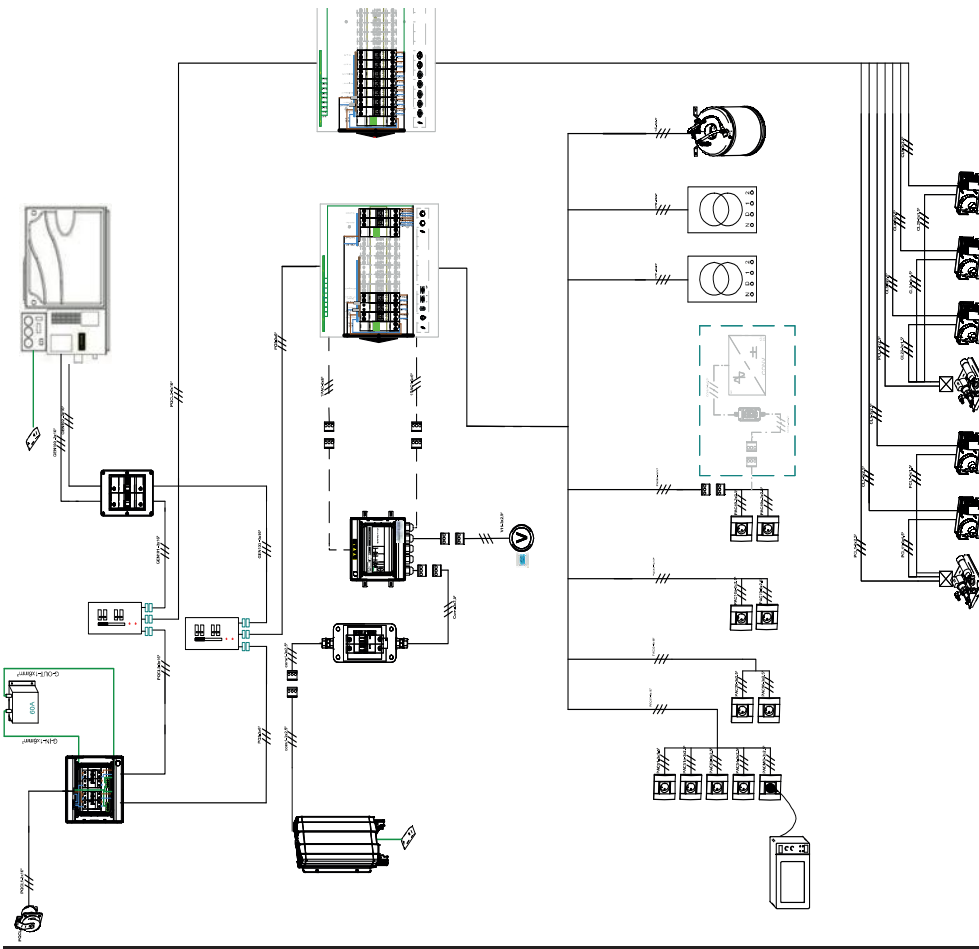

120V/60Hz Electrical circuit

[Complete circuit=standard + option]

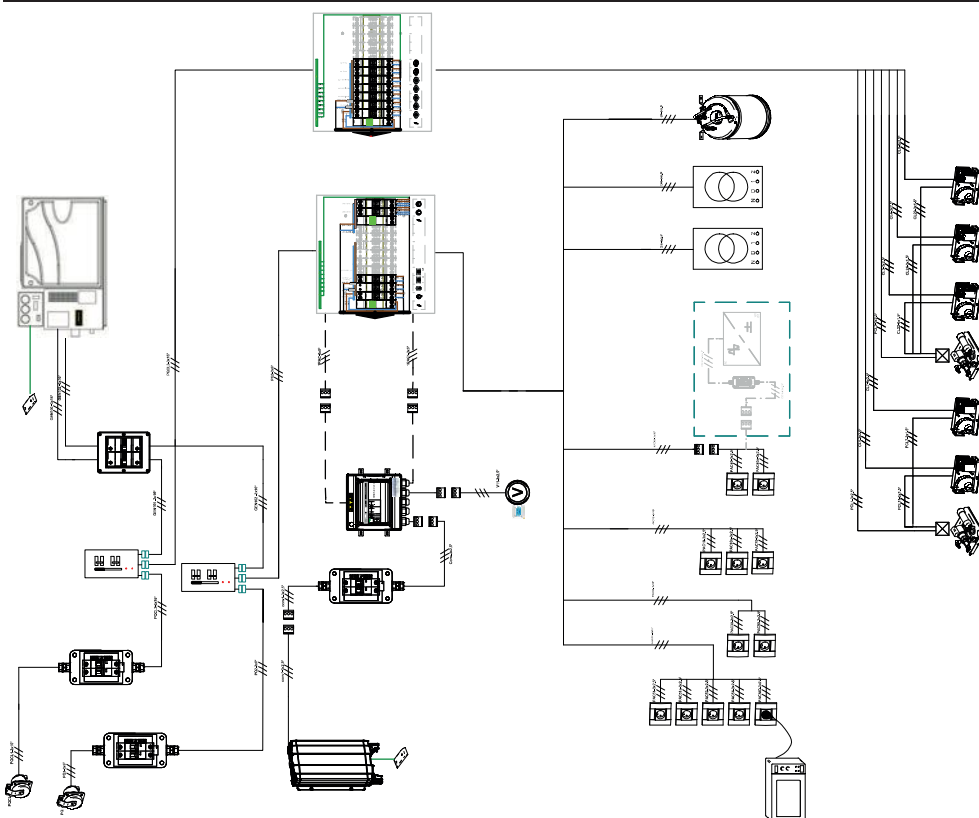

230V/50Hz Electrical circuit

[Complete circuit=standard + option]

ADDITIONAL FRESH WATER TANK 300L



[Option on port]

An additional fresh water tank is available on portside [300 L | 79 US gal].

- Capacity [option]: 300 L | 79 US gal
- **Total capacity** [standard + option]: 600 L | 159 US gal

[Not compatible with GENSET]

LOCATION ON BOARD

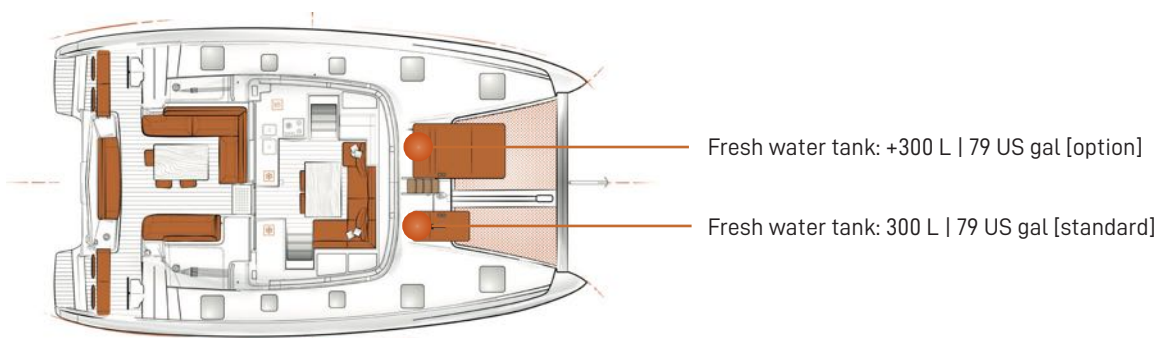

WATERMAKER 60L/H

04 TECHNICAL EQUIPMENT

WATER CIRCUIT



[Photo onboard EXCESS 11]



Brand: Dessalator
Model: DC Freedom D60 - 12V
Capacity: 60L/H | 16 US gal/H

Fresh water maker is located in starboard engine compartment.



Watermaker filter



The control panel is located on engine compartment.
Switch on DC panel [portside on chart table].

LOCATION ON BOARD

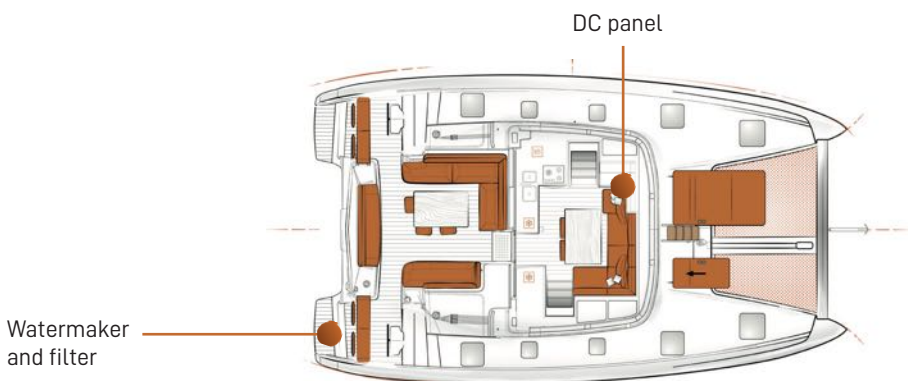

Watermaker and filter

DC panel

SEA WATER PUMP

04 TECHNICAL EQUIPMENT

WATER CIRCUIT



DEDICATED TAP



SWITCH

Flow time: 15 sec

Electric sea water pump is available, with dedicated tap.



Electric pump 8 L/min 12V

Brand: WHALE

Model: GR EAU 12V 08L MN

LOCATION ON BOARD

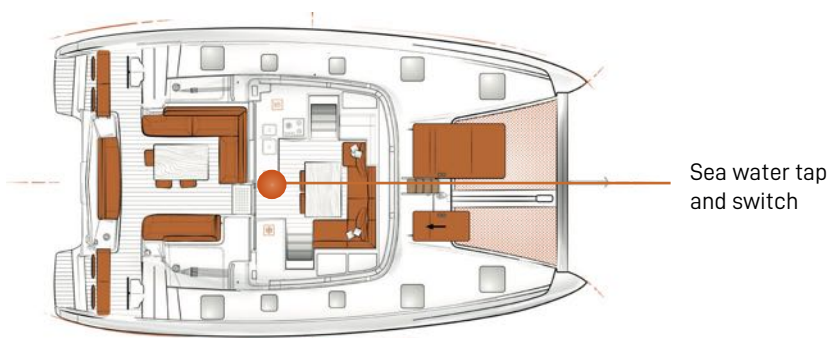

FRESH WATER DOCK INLET

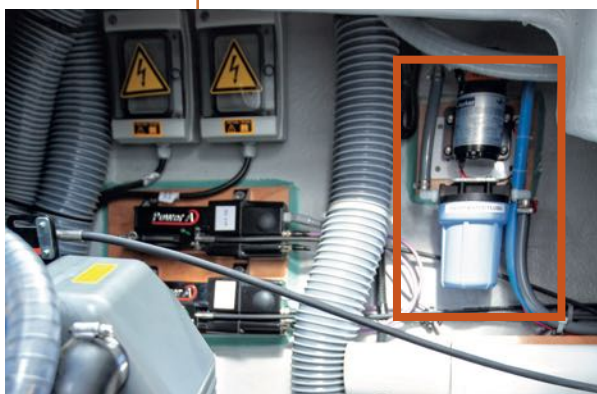

Located on port transom, fresh water pump connected to fresh water standard tank.

ON/OFF switch on water pump is located in starboard engine compartment.

LOCATION ON BOARD

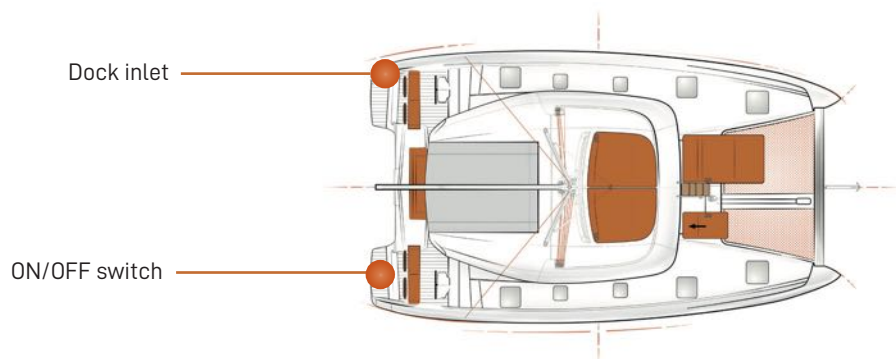

DECK WASH PUMP [SEA WATER | FRESH WATER]



A manual valve and the inlet, are located in the starboard forward deck locker. The valve allows the selection between sea water and fresh water.

The pump is accessible from starboard companionway.

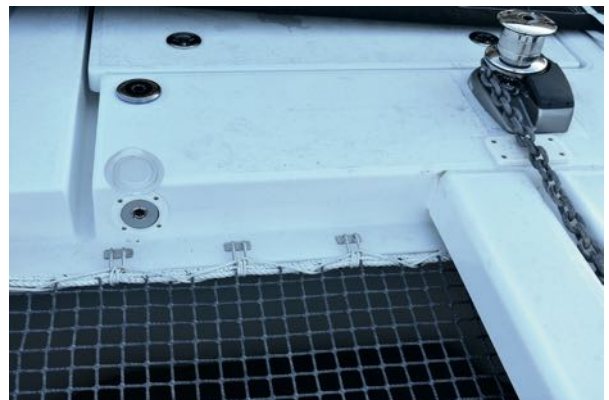

LOCATION ON BOARD

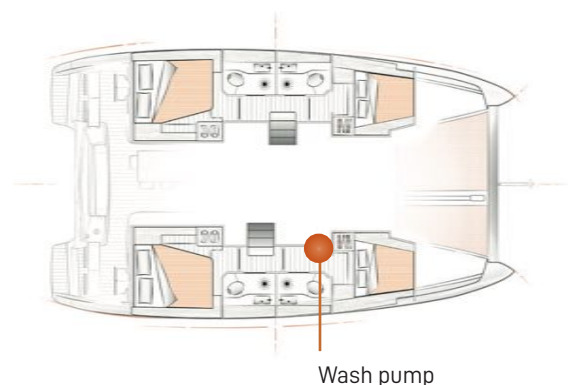
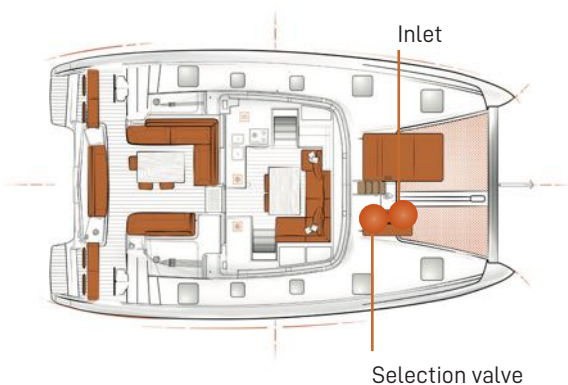

SEA WATER ELECTRICAL TOILETS

04 TECHNICAL EQUIPMENT

WATER CIRCUIT



[Owner's head]

This option is available for **3C, 4C2T and 4C4T versions**.
Replaces all the standard manual toilets.



Brand: JABSCO
Model: Quiet Flush Electric Toilets 37045 Series

05

INSIDE EXPERIENCE

Extra for Honey Teak & White lacquered wood

Extra for Valley floor

Pack 1: Fast & Curious

Pack 2: Word Hard Play Hard

Pack 3: Less is More

PVC interior upholstery

Extra settee in the salon

Additional stool

Carpet in the salon

Carpet in the Owner's cabin

Curtains on salon door and windows

INTERIOR EQUIPMENT

Berth in bow compartments

Double berth in salon

Fans in salon and cabins

Additional 130L fridge [12V]

Freezer 90L in salon [12V]

Microwave oven [230V]

Extra for adjustable wooden table in salon

Extra for CORIAN® countertop in galley

Extra for CORIAN® countertop in heads

Extra for comfort mattresses

Reverse cycle cruisair air conditioning

Diesel heater with water circuit

HI-FI

TV antenna

Prefitting for TV in the salon

FUSION sound pack in salon and cockpit

EXCESS HI-FI Pack by BOSE

BOSE soundlink revolve bluetooth speaker

EXTRA FOR HONEY TEAK & WHITE LACQUERED WOOD

05 INSIDE EXPERIENCE



[White lacquered wood | Option]



[Honey teak | Standard]

[Color upholstery no longer available]

EXTRA FOR HONEY TEAK & WHITE LACQUERED WOOD

Standard wood



Honey teak

Wood upgrade

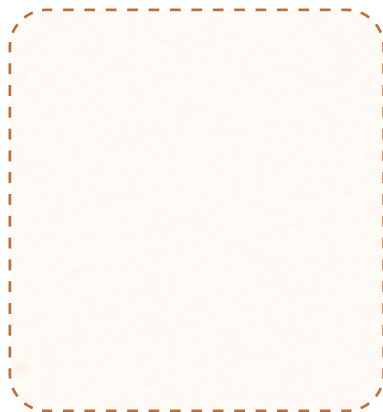

White lacquered wood

Floor



Sand

This option upgrades the existing standard finish [Honey teak].



Included in this option the upgrade for the forward cabins: inboard niches with shelves.

EXTRA FOR VALLEY FLOOR

05 INSIDE EXPERIENCE



[Color upholstery no longer available]

Floor upgrade



Valley



This option replaces the existing standard finish [Sand floor].



Inside:

- EXTRA FOR FABRIC AND MANUFACTURING FINISHING INTERIOR UPHOLSTERY: Salon and Owner's cabin [NIMBUS - Sunbrella® SAV J350]
- DECORATIVE CUSHIONS KIT [See dedicated page]
- LEATHERETTE STORAGE | FOLDER ON BULKHEAD IN LIEU OF STANDARD [French Roast]
- INTERIOR INDIRECT LIGHTING

Sofa

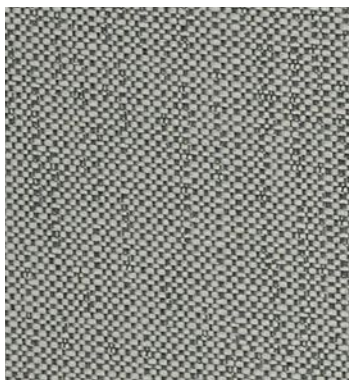

Nimbus

Storage | Folder on bulkhead

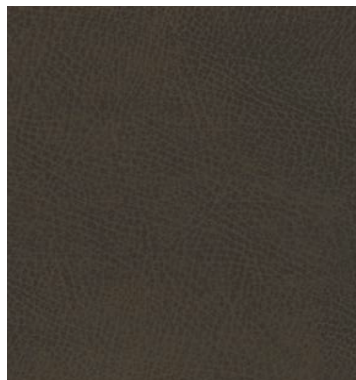

French Roast

Decorative cushions

x2

SOOTY



NATTE SOOTY NAT 10030
MARBLE SJA 3966 [Piping]

45 x 45 cm | 1'5" x 1'5"

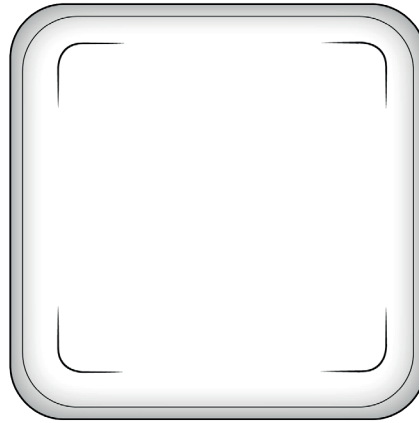

x1

SNOW

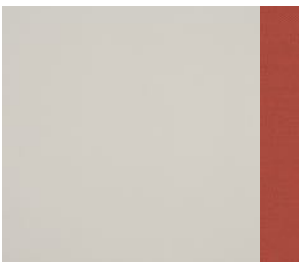

LOPI SNOW LOP R033
PAPRIKA SJA 3939 [Piping]

45 x 45 cm | 1'5" x 1'5"

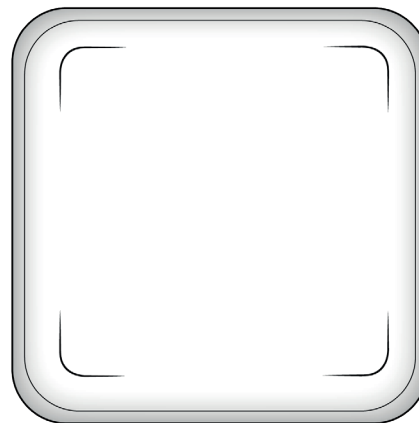

x1

PAPRIKA

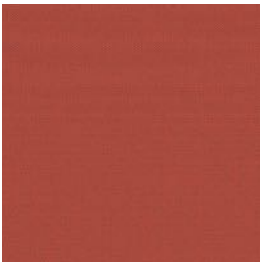

PAPRIKA SJA 3939

47 x 28 cm | 1'6" x 0'11"

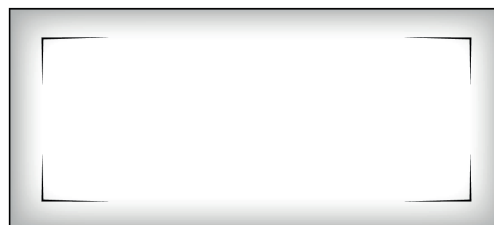



Inside:

- EXTRA FOR FABRIC AND MANUFACTURING FINISHING INTERIOR UPHOLSTERY: Salon and Owner's cabin [SLATE - Sunbrella® ARC R056]
- DECORATIVE CUSHIONS KIT [See dedicated page]
- LEATHERETTE STORAGES IN LIEU OF STANDARD [French Roast]
- INTERIOR INDIRECT LIGHTING

Sofa



Slate

Storage | Folder on bulkhead



French Roast

Decorative cushions

x2

INDIGO

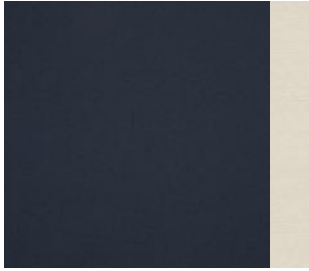

HERITAGE INDIGO - 18017 00
NATURAL SJA 5404 [Piping]

45 x 45 cm | 1'5" x 1'5"

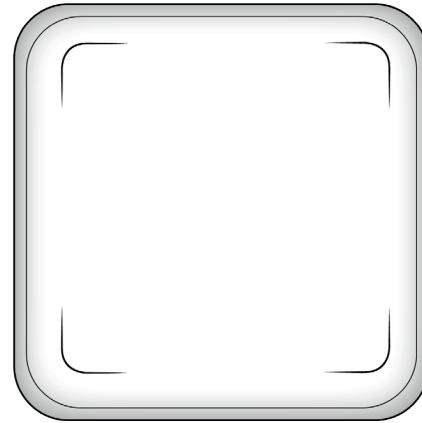

x1

BLUE STORM

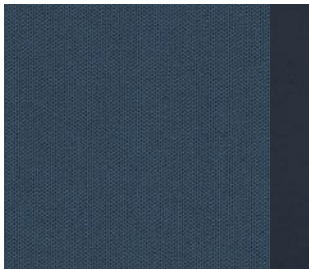

BLUE STORM SJA 3942
HERITAGE INDIGO - 18017 00 [Piping]

45 x 45 cm | 1'5" x 1'5"

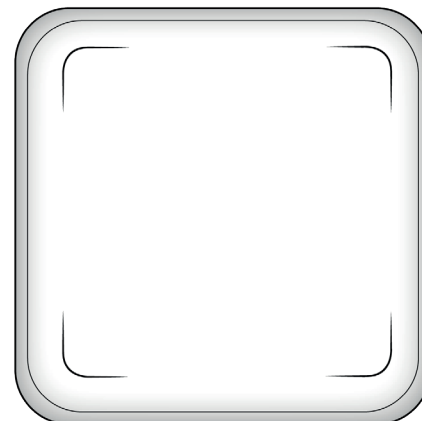

x1

LEAD CHINE

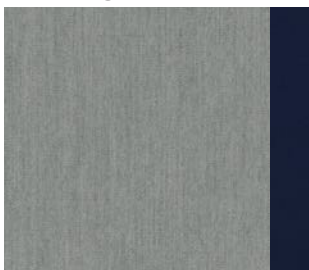

LEAD CHINE SJA 3756
RIVIERA BLUE SJA 3717 [Piping]

47 x 28 cm | 1'6" x 0'11"

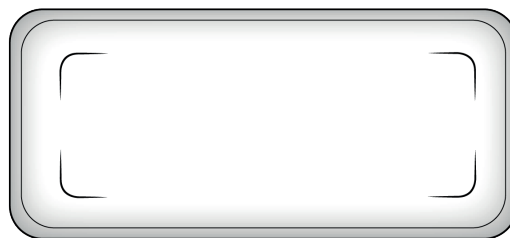



Inside:

- EXTRA FOR FABRIC AND MANUFACTURING FINISHING INTERIOR UPHOLSTERY: Salon and Owner's cabin [IPE - Sunbrella® ARC R054]
- DECORATIVE CUSHIONS KIT [See dedicated page]
- LEATHERETTE STORAGES IN LIEU OF STANDARD [French Roast]
- INTERIOR INDIRECT LIGHTING

Sofa



Ipe

Storage | Folder on bulkhead



French Roast

Decorative cushions

x2

HENNA



MEZZO HENNA 10223
HERITAGE ASH - 18001 00 [Piping]

45 x 45 cm | 1'5" x 1'5"

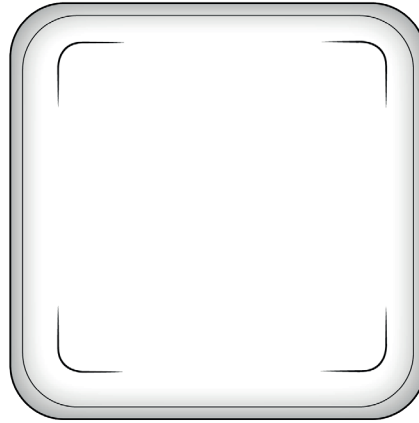

x1

ASH



HERITAGE ASH - 18001 00

45 x 45 cm | 1'5" x 1'5"

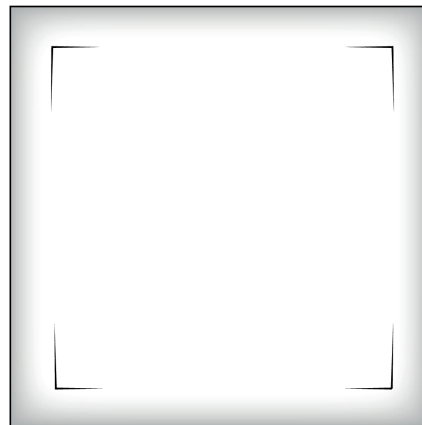

x1

CHALK

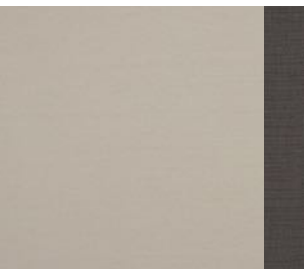

NATTE LINEN CHALK NAT 10151
DARK SMOKE SJA 33792 [Piping]

47 x 28 cm | 1'6" x 0'11"



PVC INTERIOR UPHOLSTERY

Interior upholstery in white PVC, in salon sofa and settees.
Includes all settees in the salon and in the owner's cabin plus stool [3-cabin version]

Fabric changes: PVC upholstery
Same foam shape and manufacturing finishing as per standard.



Color: Snow white
Spradling® NUA-2450 / 11-0104 TPX

EXTRA SETTEE IN THE SALON

05

INSIDE EXPERIENCE

UPHOLSTERIES

A - STANDARD FOAM AND MANUFACTURING FINISHING



[Non-contractual photo]

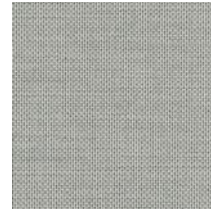

Color: Silver
Bru® Lounge Forte - 161 Silver



Color: Snow White
Spradling® NUA-2450 / 11-0104 TPX

Dimensions: 890 H x 435 W mm | 2'9" x 1'4"
Thickness: 130 mm | 0'4"

B - OPTIONAL INSIDE TAILORED PACK



[WORK HARD PLAY HARD on photo]

Foam as per standard. Leather upgrade finishing.

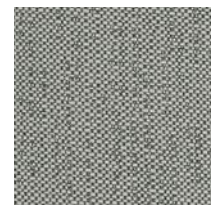

FAST AND CURIOUS
Color: Nimbus
Sunbrella® SAV J350



WORK HARD PLAY HARD
Color: Slate
Sunbrella® ARC R056

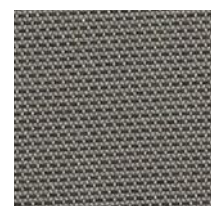

LESS IS MORE
Color: Ipe
Sunbrella® ARC R054

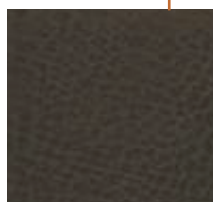

Leather strip upgrade finishing
Ultrafabrics® Ultra Leather
French Roast - 535-3231
[Same finishing for all tailored pack]

ADDITIONAL STOOL

05

INSIDE EXPERIENCE

UPHOLSTERIES

A - STANDARD FOAM AND MANUFACTURING FINISHING

Stool made in foam covered with fabric.
Dimensions: 423 H x 437 W mm | 0'16" x 0'17"

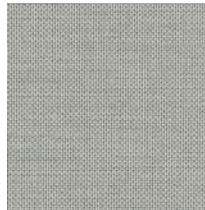

Color: Silver
Bru® Lounge Forte - 161 Silver



Color: Snow White
Spradling® NUA-2450 / 11-0104 TPX

B - OPTIONAL INSIDE TAILORED PACK



Foam as per standard. Leather upgrade finishing.

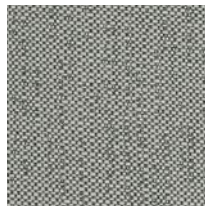

FAST AND CURIOUS
Color: Nimbus
Sunbrella® SAV J350

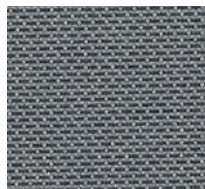

WORK HARD PLAY HARD
Color: Slate
Sunbrella® ARC R056

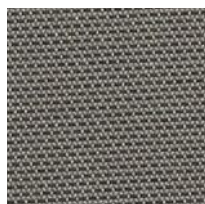

LESS IS MORE
Color: Ipe
Sunbrella® ARC R054

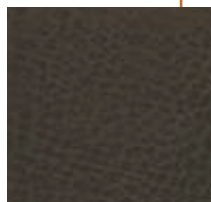

Leather strip upgrade finishing
Ultrafabrics® Ultra Leather
French Roast - 535-3231
[Same finishing for all tailored pack]

CARPET IN SALON

05 INSIDE EXPERIENCE

UPHOLSTERIES



[color no longer available]

This option includes **1 carpet in salon**.
2 colors available: grey [African Grey] or beige [African Chalk]
Dimensions: 1,720 x 1,620 mm | 5'7" L x 5'3" W



African Grey



African Chalk

LOCATION ON BOARD

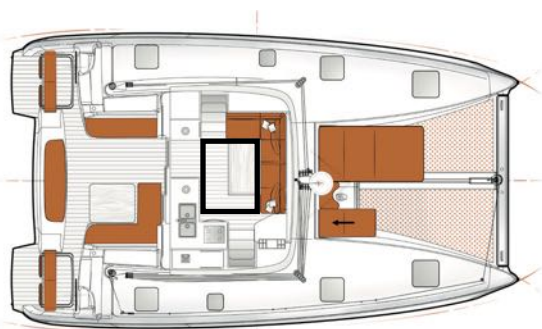

CARPET IN OWNER'S CABIN

05

INSIDE EXPERIENCE

UPHOLSTERIES



[color no longer available]



African Grey



African Chalk

This option includes **1 carpet in Owner's suite** [3-cabin version].
2 colors available: grey [African Grey] or beige [African Chalk]
Dimensions: 2,740 x 700 mm | 8'11" L x 2'3" W

LOCATION ON BOARD

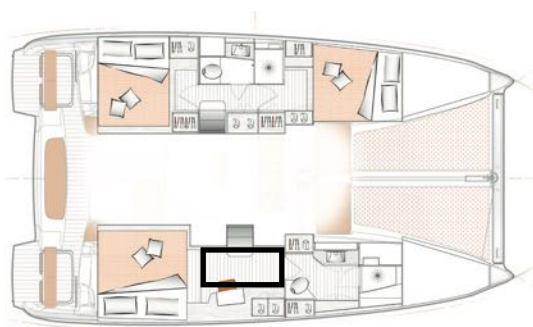

CURTAINS ON SALON DOOR AND WINDOWS

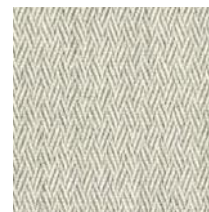

Color: Grey
SLEEP IN
Serenity-23-Whisper

NEW A2021: all salon curtains are in the same option.

The option includes:

- Curtains on aft door to cockpit
- Curtains on all roof windows in salon

BERTH IN BOW COMPARTMENTS

05

INSIDE EXPERIENCE

INTERIOR EQUIPMENT

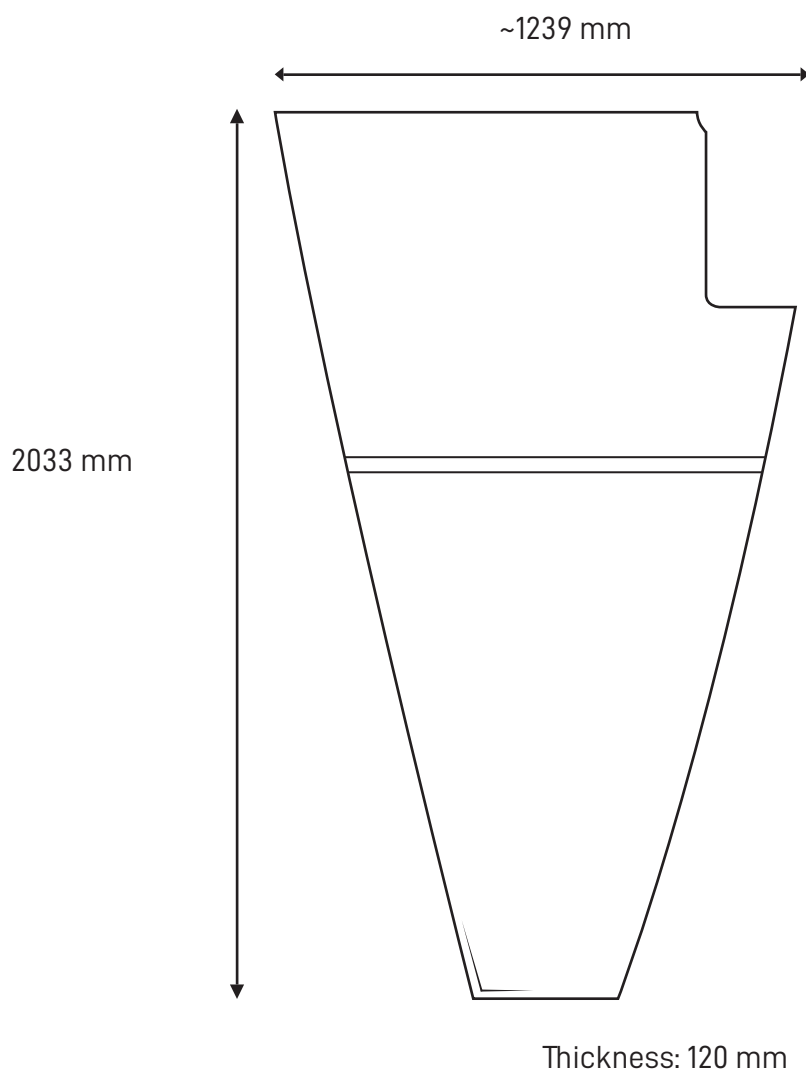

The option is available on **portside and starboard**.

Mattress included.

Dimensions: 2,030 x 940 mm | 6'7" x 3'1"

DOUBLE BERTH IN SALON



The option includes :

- 2 smaller aluminium table pedestals to low the table
- Mattresses [fabric according to client ambience selection]

Dimensions [setted bed configuration]:
1,830 L x 1,400 W mm | 6'0" x 4'7"

[Not compatible with extra for adjustable wooden table in salon]



[Photo onboard EXCESS 11]

LOCATION ON BOARD

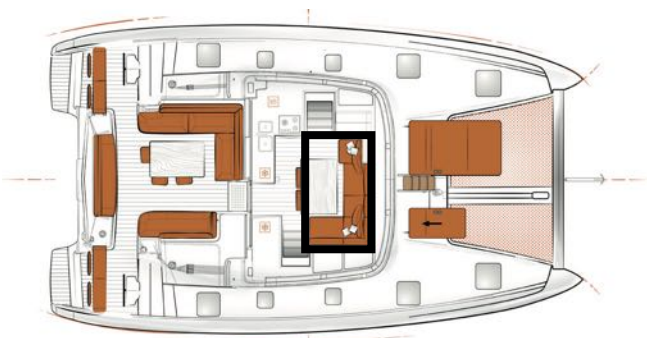

FANS IN SALON AND CABINS

05

INSIDE EXPERIENCE

INTERIOR EQUIPMENT



Brand/Model: BORA

Color: White

The option includes:

- 1 Fan per cabin
- 2 Fans in Owner's suite
- 2 Fans in salon

LOCATION ON BOARD

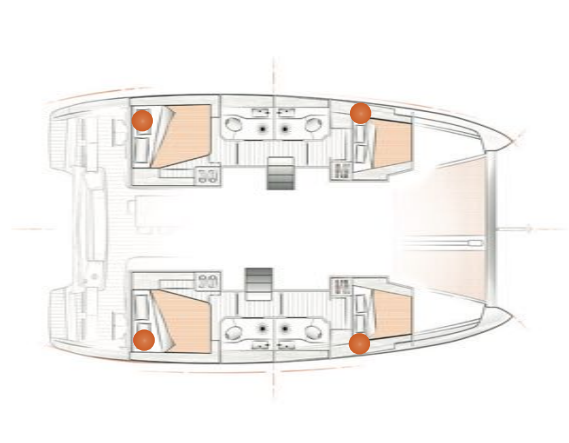
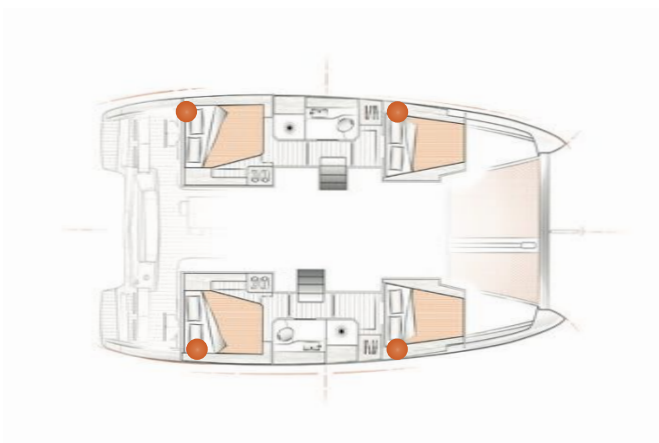
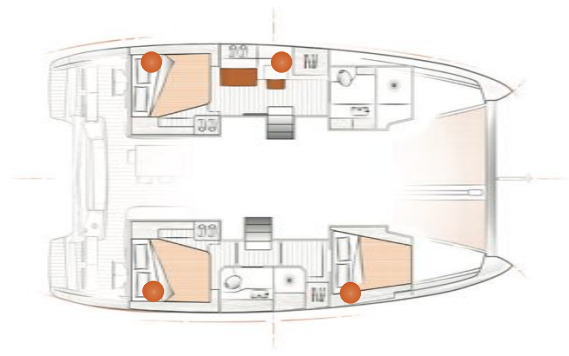
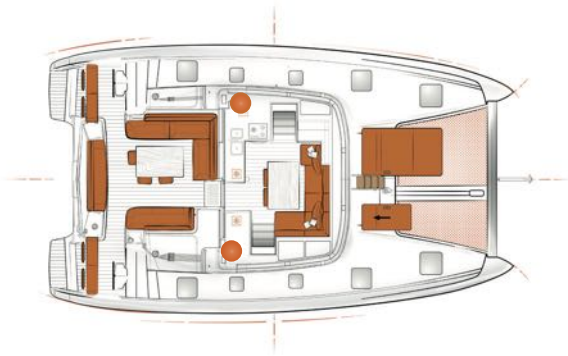

ADDITIONAL FRIDGE 130L



Additional 12V fridge [130 L | 34 US gal] on port galley. Replaces the storage unit per standard. [Not compatible with freezer option]



Brand: Webasto
Model: CRUISE 130 [Inox] Clean Touch

[WEBASTO -12V Fridge](#)

LOCATION ON BOARD

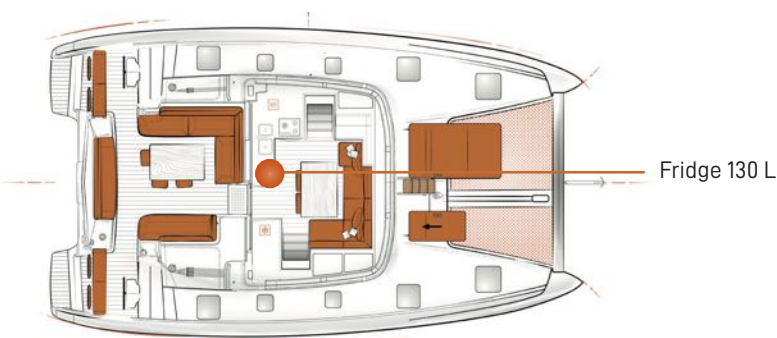

FREEZER 90L IN SALON



Optional freezer [90 L | 24 US gal] on port galley. Replaces the storage unit per standard.
[Not compatible with fridge option]



Brand: Webasto
Model: CRUISE 90 Freezer [Inox] Clean Touch

[WEBASTO - 12V Freezer](#)

LOCATION ON BOARD

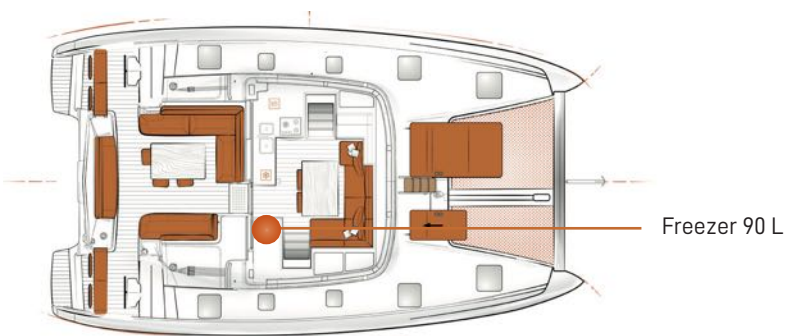

MICROWAVE OVEN

05

INSIDE EXPERIENCE

INTERIOR EQUIPMENT



[Model no longer available]

A microwave with grill and oven functions is available **on 230V and 120V.**



230V Microwave

Brand: Whirlpool
Model: MWD 121/SIL [Ref MWD121SIL]



120V Microwave

Brand: Danby
Model: Designer 0.7 pi3 [DMW077BLSDD]

LOCATION ON BOARD

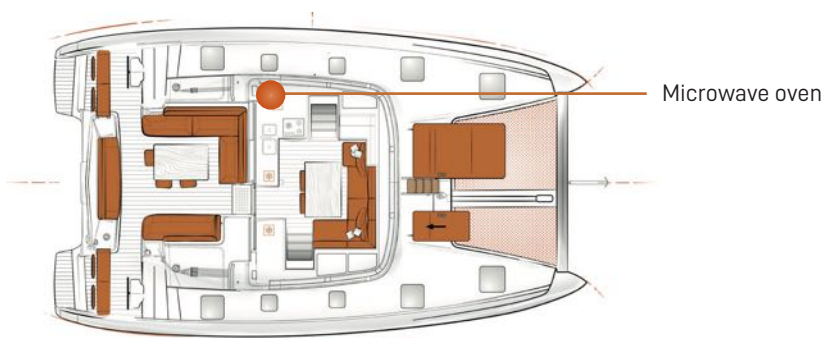

EXTRA FOR ADJUSTABLE WOODEN TABLE IN SALON

05 INSIDE EXPERIENCE

INTERIOR EQUIPMENT



Convertible dining table into a coffee table
[modular table]

The option includes :

- 1 aluminium table pedestal to low and raise the table
- folding table top

Dimensions

Coffee table: 600 L x 750 W mm | 1'11" x 2'5"

Dining table: 1,200 L x 750 W mm | 3'11" x 2'5"

[Not compatible with double berth in salon]



[Standard]

EXTRA FOR CORIAN COUNTERTOP IN GALLEY

05

INSIDE EXPERIENCE

INTERIOR EQUIPMENT



The option replaces the standard finish [2 different countertops per standard].
By choosing the option, you're **fully upgrading your galley countertop** with Corian®:

[Standard on **portside**]



Grigio Sasso | Laminate
Color: grey

[Standard on **starboard**]

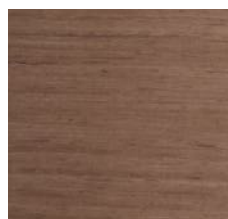

Honey Teak
Color: wood

Corian® galley countertop [on **port and starboard**]

[Option]

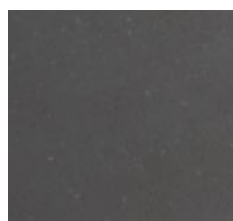

CORIAN®
Color : Ash Concret

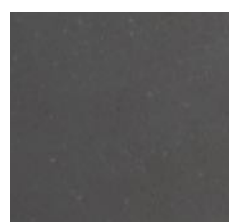

CORIAN®
Color : Ash Concret

LOCATION ON BOARD

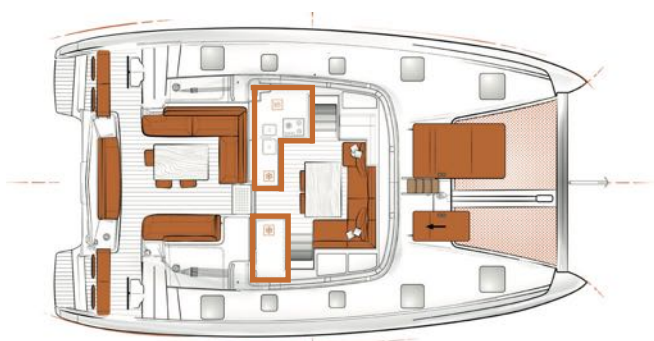

EXTRA FOR CORIAN COUNTERTOP IN HEADS

AVAILABLE FOR 3 & 4 CABIN VERSIONS



The option replaces the standard finish.
By choosing the option, you're fully upgrading:

- Countertop
- Wall-mounted Corian
- Shower

[Option]

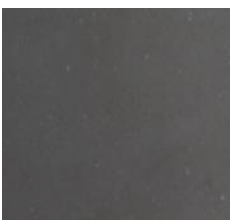

CORIAN®
Color : Ash Concret

[Standard: White GRP]

EXTRA FOR COMFORT MATTRESSES

05

INSIDE EXPERIENCE

INTERIOR EQUIPMENT

AVAILABLE FOR 3 & 4 CABIN VERSIONS



The option upgrades mattresses in forward and aft cabins.

[Option]

Thickness: 150 mm | 0'5"

Composition:

- 200 g/m² Wadding
- HR Foam [density 40 kg | 88 lbs]
- Pocketed coils [innersprings]

[Standard]

Thickness: 120 mm | 0'4"

Composition:

- HR Foam [density 35 kg | 77 lbs]

REVERSE CYCLE CRUISAIR AIR CONDITIONING

05

INSIDE EXPERIENCE

INTERIOR EQUIPMENT

AVAILABLE FOR 3 & 4 CABIN VERSIONS [230V | 120V]

[PANDA genset 10kVA option mandatory]
[Not compatible with diesel water heater option]

Seawater-cooled AC unit: Heat is transferred from the cabin air to the refrigerant gas to the seawater
Reverse cycle on heating mode

Total BTU :

3 Cabin version: 44,000 BTU

4 Cabin version: 48,000 BTU

1 Control device per cabin

1 Control device at chart table in salon

Blowing grids



Air conditioning shore power



Control device



Control device



[non-contractual photo]

REVERSE CYCLE CRUISAIR AIR CONDITIONING

05

INSIDE EXPERIENCE

INTERIOR EQUIPMENT

AVAILABLE FOR 3 & 4 CABIN VERSIONS [230V | 120V]

LOCATION ON BOARD

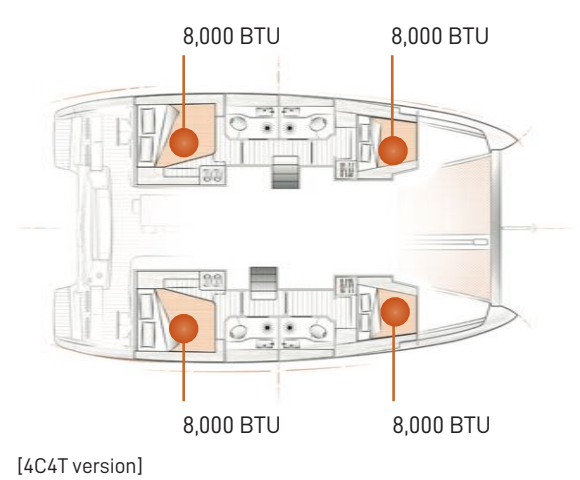
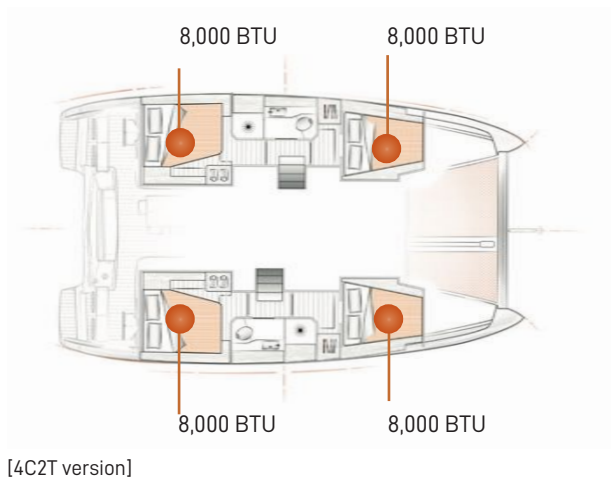
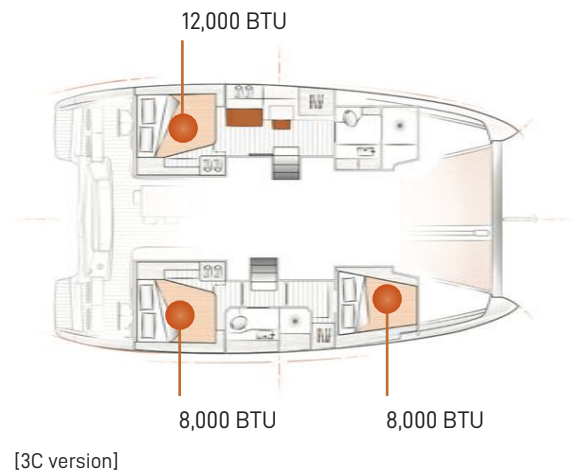
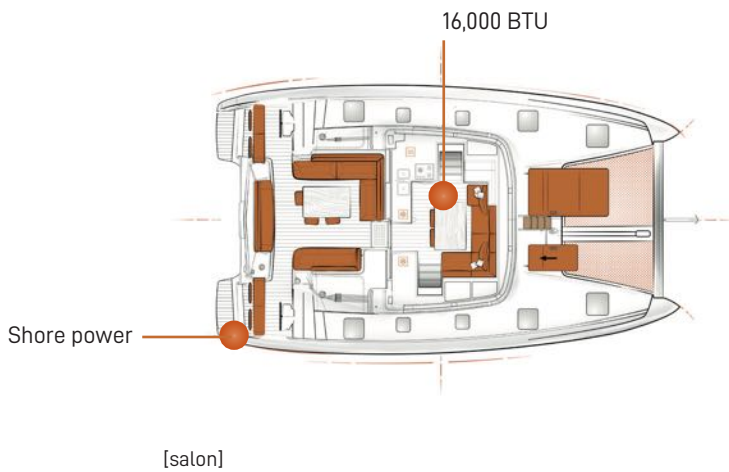

Electrical specification:

230V version: 1 x 32A shore power on starboard
In addition to 1 x 32A shore power [SAIL AWAY]

120V version: 1 x 50A shore power on starboard
Replaces 32A shore power [SAIL AWAY]

DIESEL HEATER WITH WATER CIRCUIT

[Not compatible with reverse cycle cruises air conditioning option]

Brand : Eberspracher
Model : HYDRONIC M-II
Power: 12Kw

Heater located in the salon.

TV ANTENNA

05

INSIDE EXPERIENCE

HI-FI

The option includes :

- TV antenna
- TV antenna amplifier
- TV cable pre-installed in roof to link amplifier and antenna

PREFITTING FOR TV IN THE SALON

05

INSIDE EXPERIENCE

HI-FI



NEW A2022: Prefitting option only.

Available for 120 and 230V.

Starting from 12#30

TV not included.

FUSION SOUND PACK IN SALON AND COCKPIT

NEW A2021: FUSION sound pack

- FUSION stereo unit [Apollo MS-RA670]
- USB socket x1
- Loudspeakers x2 in the salon [FM-F65RW]
- Loudspeakers x2 in the aft cockpit [FM-F65RW]



Stereo unit

Brand: FUSION
Model: Apollo MS-RA670
Color: Black



Loudspeaker

Brand: FUSION
Model: FM-F65RW
Color: White

Sources:
RADIO / WiFi / Bluetooth / AUX

Control:
From the front panel / From the navigation screens / From the FUSION app

Same audio source and volume in the salon and outside.

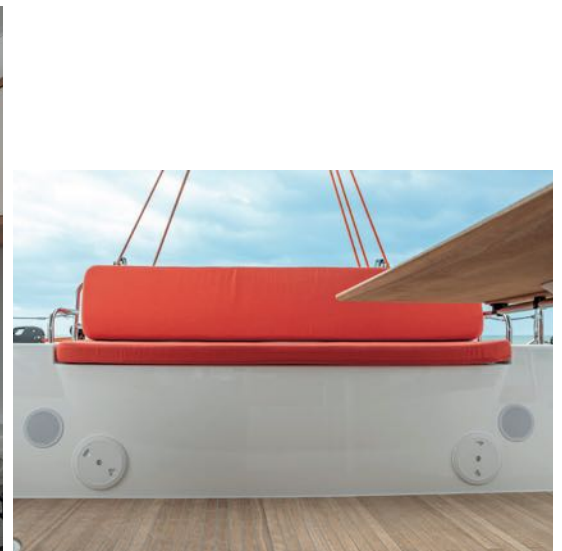

EXCESS HIFI PACK BY BOSE

05

INSIDE EXPERIENCE

HI-FI



The option includes :

- Soundlink revolve bluetooth speaker [BOSE®]
- Charging Cradle [BOSE®]
- Excess storage box

Speaker

- 360° uniform coverage
- IPX4 Splashproof
- 12 Hours of autonomy
- Bluetooth wireless pairing with voice prompts
- Take calls and access Siri or Google Now directly Pair two speakers together
- Multi-connect to two devices
- Bose Connect app
- NFC pairing
- Charges via micro-USB Type-B port
- Auxiliary input
- Dimensions: 152 x 82 mm | 0'6" x 0'3"
- Color: Grey or black



Charging cradle

- The speaker will work even during charging
- USB Port for plugging the cradle
- Color: Black

High-quality and brand customization, this Pack offers a fully movable Hi-Fi solution onboard.



BOSE SOUNDLINK REVOLVE BLUETOOTH SPEAKER

05

INSIDE EXPERIENCE

HI-FI



The BOSE® speaker is available single.

Speaker

- 360° uniform coverage
- IPX4 Splashproof
- 12 Hours of autonomy
- Bluetooth wireless pairing with voice prompts
- Take calls and access Siri or Google Now directly

Pair two speakers together

- Multi-connect to two devices
- Bose Connect app
- NFC pairing
- Charges via micro-USB Type-B port
- Auxiliary input
- Dimensions: 152 x 82 mm | 0'6" x 0'3"
- Color: Grey or black



06

ACCESSORIES

Dinghy pack CL290 with Yamaha engine 10HP

Windsup

Safety kit 8 PAX

Liferaft 8 PAX

EXCESS tool box

EXCESS mooring kit

DINGHY PACK CL290 WITH YAMAHA ENGINE 10HP

06 ACCESSORIES



Brand: HIGHFIELD
Model: CL290
Rated output: 120W
Dimensions: 2,90 x 2,01 m | 9'6" x 6'7"
Weight [Empty]: 57 kg | 126 lbs
Maximum charge: 480 kg | 1,058 lbs
Engine: Yamaha 10HP

Delivered with :

- Waterproof storage bag
- Security Kit
- Reams
- Blower
- Portable fuel tank [12L | 3 US gal]

HIGHFIELD
aluminium boats



The Windsup is a windsurfing board that you can paddle, delivering authentic windsurfing with inflatable versatility. This is a board with all the practical benefits of an inflatable SUP that's also designed specifically with beginner windsurfers in mind, but can make a great coastal cruiser for more experienced riders.



Brand: RED PADDLE COW

Dimensions:

Length: 3,26 m | 10'8"

Width: 838 mm | 2'8"

Thickness: 120 mm | 0'4"

Volume: 257 L | 68 Us gal

Rider weight: until 120 kg

Sail area: 4,5 m² | 48 sq ft

Mast height: 4 m | 13'1" [provided in 2 parts]

Includes :



BAG



PUMP



FINS



PADDLES



RIGS



ACCESSORIES

WINDSUP

06 ACCESSORIES

INFLATABLE PADDLE BOARD



FINS



RIGS



ACCESSORIES



PUMP



PADDLES



BAG



SAFETY KIT 8 PAX

06

ACCESSORIES



- 1 x Horse shoe buoy cover
- 1 x Buoy and floating light
- 1 x Floating line Ø8mm [30 m | 98'5"]
- 1 x Shroud shears 90 cm | 2'11" [maximum 16mm diameter]
- 8 x 165N lifejacket with crotch and strap
- 8 x Flashing light
- 8 x Harness tether
- 1 x Flare kit (6 x Hand flare - 4 x Parachute flare - 2 x Floating smoke)
- 1 x Set of 2 Wichard adjustable jackstays
- 1 x Set of 9 wooden bungs size S
- 1 x Set of 9 wooden bungs size L
- 1 x 10L bucket with 1.5m floating line
- 1 x Set of 3 emergency navigation lights
- 3 x LR20 batteries
- 1 x Flag N 30 x 40 cm | 0'11" x 1'3"
- 1 x Flag C 30 x 40 cm | 0'11" x 1'3"
- 1 x Flag Q 30 x 40 cm | 0'11" x 1'3"
- 1 x Waterproof flash light (4 LED)
- 1 x Search light
- 1 x Lead line (30 m | 98'5" with marke every meter)
- 1 x Bailer
- 1 x ABC 6 kg | 13 lbs extinguisher (powder)
- 4 x ABC 1 kg | 2 lbs extinguisher (powder)
- 1 x Fire blanket
- 1 x TRUMP foghorn
- 1 x Black cone

LIFERAFT 8 PAX

06 ACCESSORIES



Brand: Seasafe

Size: 8 persons

Model: 8 pax [24h+] ISO 9650-1 SOLAS pack B

The option includes :

- 1 Liferaft 8 pax [24h+] ISO 9650-1 SOLAS pack B - Seasafe
- 1 Baller
- 2 Sponges
- 2 Paddles
- 1 First Aid kit
- 1 Whistle
- 1 Waterproof torch with spare batteries and bulb
- 1 Daylight signal mirror
- 1 Radar Reflector
- 6/pers Anti sea sickness pills
- 1/pers Sea sickness bag
- 3 Hand flares
- 2 Parachute rockets
- 1 Smoke signal
- 2 Survival blankets
- 1 Repair outfit
- 1 Inflating pump
- 1 Fishing kit
- 1 Rescue quoit and line [30 m | 98'5"]
- 1 Floating knife
- 1 Sea anchor and cord [30 m | 98'5"]



The Facom toolbox includes:

- 1 PVC coated fabric softbag [50 cm | 1'7"]
- 12 Metric offset combination wrench
- 1 Chromed sheath adjustable wrench
- 9 Allen wrench keys - sperical head
- 1 Set of sockets - metric [23 pieces]
- 7 Stainless steel screwdrivers
- 1 Multigrip pliers [25 cm | 0'9"]
- 1 Combination pliers [18 cm | 0'7"]
- 1 Adaptable-tip sledgehammer [40 mm | 0'1"]
- 1 Hacksaw frame
- 1 Caliper
- 1 Tape measure
- 1 Cutter with 9 mm snap-off blades
- 1 Riveting engineers hammers [26 mm | 0'1"]
- 1 Masking tape
- 100 White nylon cable ties 6.6
- 1 Lubricant spray WD 40
- 1 Adjustable oil-filter wrench
- 1 PTFE Roll [12 m | 39'4"]
- 1 Half-round file [200 mm | 0'7"]
- 1 Double sided tape [25 m | 82']
- 1 Prism 401 glue [3 g tube]
- 1 Voltage tester
- 1 Electrical tape - black [10 m | 32'9"]

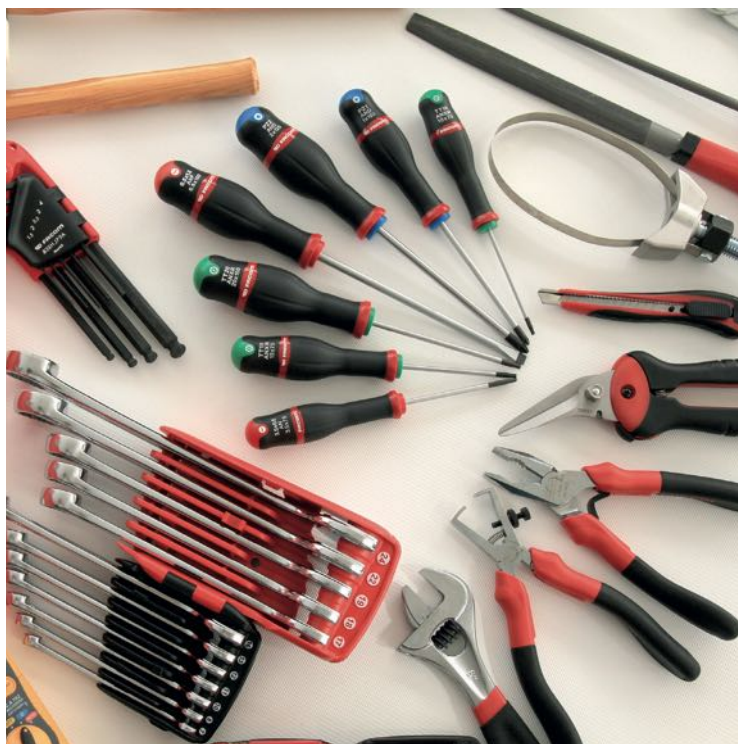

EXCESS MOORING KIT



The option includes:

- 4 Dock lines
- 6 Cylindrical inflatable fenders [with covers and bag]
- 12V Blower



CNB
162, quai de brazza CS 81217
33072 Bordeaux Cedex France

EXCESS-CATAMARANS.COM